

# Complementary instructions



**Read carefully before  
using the machine!**

**Keep for future reference.**

This operator's manual/mounting manual is to be considered as part of the machine. Suppliers of new and second-hand machines are required to document in writing that the operator's manual/mounting manual was delivered with the machine and handed over to the customer..

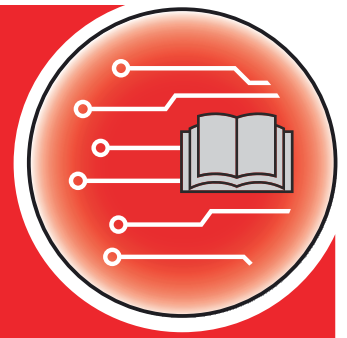

# AXENT ISOBUS

**Version 6.00.00**

5901646-**p**-en-1124

Original instructions

Dear customer,

By purchasing the machine control unit for the AXENT ISOBUS AXENT 100.1 mineral fertilizer spreader, you have shown confidence in our product. Thank you very much! We want to justify this confidence. You have purchased a powerful and reliable machine control unit.

However, in case unexpected problems arise, our customer service department is always there for you.



**Please read this supplementary manual as well as the operator's manual for the machine carefully before using the machine, and follow the advice given.**

This manual may also describe equipment that is not included in your machine control unit.

### **Technical improvements**

We continuously strive to improve our products. For this reason, we reserve the right to make any improvements and changes to our machine that we consider necessary without notice. We do not accept any obligation to make such improvements or changes on machines that have already been sold.

We will be pleased to answer any other questions that you might have.

Yours sincerely

RAUCH Landmaschinenfabrik GmbH

# Table of contents

<b>1</b>	<b>User instructions</b>	<b>7</b>
1.1	About this operator's manual	7
1.2	Meaning of warnings	7
1.3	Notes on text descriptions	8
1.3.1	Instructions and procedures	8
1.3.2	Lists	8
1.3.3	References	8
1.3.4	Menu hierarchy, keys and navigation	9
<b>2</b>	<b>Layout and function</b>	<b>10</b>
2.1	Display	10
2.1.1	Description of the working screen	10
2.1.2	Display fields	11
2.1.3	Display of the metering slide status	13
2.1.4	Display of sections	14
2.1.5	Display of the EMC status	15
2.2	Library of icons used	15
2.2.1	Navigation	15
2.2.2	Menus	16
2.2.3	Working screen icons	16
2.2.4	Other icons	19
2.3	Structural menu overview	22
<b>3</b>	<b>Attachment and installation</b>	<b>24</b>
3.1	Tractor requirements	24
3.2	Connections, sockets	24
3.2.1	Power supply	24
3.2.2	Connecting the machine control unit	24
3.2.3	Overview of actuators and sensors	25
3.2.4	Metering slide preparation	27
<b>4</b>	<b>Operation</b>	<b>28</b>
4.1	Switching on the machine control unit	28
4.2	Navigation within the menus	29
4.3	Functional description: Status indicator	30
4.3.1	Spreading material supply	30
4.3.2	Empty hopper	30
4.4	Main menu	31
4.5	Fertilizer settings	32

4.5.1	Application rate .....	35
4.5.2	Setting the working width .....	36
4.5.3	Flow factor .....	37
4.5.4	Drop point .....	38
4.5.5	Calibration test .....	38
4.5.6	Disc type .....	41
4.5.7	Rotation speed .....	41
4.5.8	Boundary spreading mode .....	43
4.5.9	Boundary spreading quantity .....	43
4.5.10	Calculate OptiPoint / OptiPoint Pro .....	44
4.5.11	Headland mode .....	45
4.5.12	GPS Control info .....	47
4.5.13	Fertilizer charts .....	48
4.6	Fertilizer settings (UNIVERSAL PowerPack) .....	52
4.6.1	Application rate .....	53
4.6.2	Setting the working width .....	54
4.6.3	Flow factor .....	55
4.6.4	Disc type .....	56
4.6.5	Rotation speed .....	57
4.7	Machine settings .....	57
4.7.1	AUTO/MAN mode .....	60
4.7.2	+/- quantity .....	61
4.7.3	Overloading function operating mode .....	62
4.7.4	Settings for lime operation .....	63
4.7.5	Belt speed .....	64
4.7.6	+/- belt speed .....	64
4.7.7	Opening the pre-metering slides .....	65
4.7.8	Opening adjustment .....	65
4.7.9	Forward speed calibration .....	65
4.8	Fast emptying .....	68
4.9	System/Test .....	70
4.9.1	Total data counter .....	71
4.9.2	Test/diagnosis .....	71
4.9.3	Service .....	76
4.10	Info .....	76
4.11	Weighing/Trip counter .....	76
4.11.1	Trip counter .....	77
4.11.2	Rest (kg, ha, m) .....	78
4.11.3	Zero scales .....	78
4.12	Operating lights (SpreadLight) .....	79
4.13	Special functions .....	80
4.13.1	Changing the system of units .....	80
4.13.2	Using the joystick .....	81
4.13.3	WIFI module .....	85
<b>5</b>	<b>Spreading operation with AXIS-PowerPack .....</b>	<b>87</b>
5.1	Overloading .....	87

---

5.1.1	Overloading in automatic operating mode .....	87
5.1.2	Overloading in manual operating mode.....	88
5.2	Fertilizer spreading .....	89
5.2.1	Working with sections.....	89
5.2.2	Spreading with the automatic operating mode (AUTO km/h + AUTO kg).....	94
5.2.3	Idle measurement.....	95
5.2.4	Spreading with the AUTO km/h operating mode.....	97
5.2.5	Spreading with the MAN km/h operating mode.....	98
5.2.6	Spreading in the MAN scale operating mode .....	99
5.2.7	GPS control.....	101
<b>6</b>	<b>Spreading operation with the UNIVERSAL PowerPack .....</b>	<b>105</b>
6.1	Overloading .....	105
6.2	Spreading lime.....	105
6.2.1	Adjustments.....	106
6.2.2	Starting the spreading operation.....	107
<b>7</b>	<b>Alarm messages and possible causes.....</b>	<b>109</b>
7.1	Meaning of the alarm messages .....	109
7.2	Fault/alarm.....	114
7.2.1	Acknowledging an alarm message.....	114
<b>8</b>	<b>Special equipment.....</b>	<b>116</b>
<b>9</b>	<b>Guarantee and warranty.....</b>	<b>117</b>



# 1 User instructions

## 1.1 About this operator's manual

This operator's manual is an **integral part** of the machine control unit.

The operator's manual contains important instructions for **safe, proper**, and economic **use** and **maintenance** of the machine control unit. Compliance with its stipulations helps to **avoid risks**, reduce repair costs and downtime, and to increase the reliability and service life of the machine controlled with it.

The operator's manual must be kept in an easily accessible location close to where the control unit is used (e.g., in the tractor).

The operator's manual does not replace your **own responsibility** as operator and operational staff of the machine control unit.

## 1.2 Meaning of warnings

The warnings in the operator's manual are classified according to the severity of the risk and the probability of its occurrence.

The warning symbols draw attention to the residual risks to which users of the machine are exposed. The warnings used are structured as follows:

---

Symbol + **signal word**

Explanation

---

### Level of danger of warnings

The level of danger is indicated in the signal word. The levels of danger are classified as follows:

#### **DANGER!**

##### **Type and source of danger**

This warning warns of a danger posing an immediate threat to the health and life of people.

Ignoring these warnings will result in severe injury or death.

- ▶ Always observe the measures described to prevent this danger.

#### **WARNING!**

##### **Type and source of danger**

This warning warns of a potentially dangerous situation for personal health.

Ignoring these warnings leads to severe injury.

- ▶ Always observe the measures described to prevent this danger.

**⚠ CAUTION!**

**Type and source of danger**

This warning warns of a potentially dangerous situation for personal health.

Ignoring these warnings leads to injury.

- ▶ Always observe the measures described to prevent this danger.

**NOTICE!**

**Type and source of danger**

This warning warns of material and environmental damage.

Ignoring these warnings will result in damage to the machine and to the environment.

- ▶ Always observe the measures described to prevent this danger.



This is an instruction:

General instructions contain tips for the operation and information that is particularly useful, but no warnings about hazards.

## 1.3 Notes on text descriptions

### 1.3.1 Instructions and procedures

Steps that must be performed by operating staff are displayed as follows

- ▶ Instructions step 1
- ▶ Instructions step 2

### 1.3.2 Lists

Lists without a specific sequence are shown as lists with bullet points:

- Property A
- Property B

### 1.3.3 References

References to other sections in the document are shown with paragraph number, header text and/or page number:

- **Example:** Please also note 2 *Layout and function*



References to other documents are shown as information or instructions without the exact chapter or page number:

- **Example:** Follow the instructions in the operator's manual of the universal drive shaft manufacturer.

### 1.3.4 Menu hierarchy, keys and navigation

**Menus** are the entries listed in the **main menu** window.

The menus list **submenus and/or menu items** where settings can be made (selection lists, text or number entries, starting a function).

The various menus and buttons of the machine control unit are illustrated **in bold letters**.

The hierarchy and the path to the requested menu item are marked with an > (arrow) between menu and/or menu item(s):

- System / Test > System / Test > Test/diagnosis means that you can reach the menu item Voltage via the menu item System / Test and the menu item Test/diagnosis.
  - The arrow > corresponds to the operation of the **scroll wheel** and/or the button at the screen (touchscreen).

## 2 Layout and function



Due to the great variety of different ISOBUS-compatible terminals, this chapter is limited to the functions of the electronic machine control system without indicating a specific ISOBUS terminal.

- Please observe the instructions for the operation of your ISOBUS terminal in the corresponding operator's manual.

### 2.1 Display

The display shows the current status information as well as the selection and input options for the electronic machine control unit.

The most important information concerning the operation of the machine is displayed in the **working screen**.

#### 2.1.1 Description of the working screen



The exact representation of the working screen depends on the actual settings selected and on the machine type.

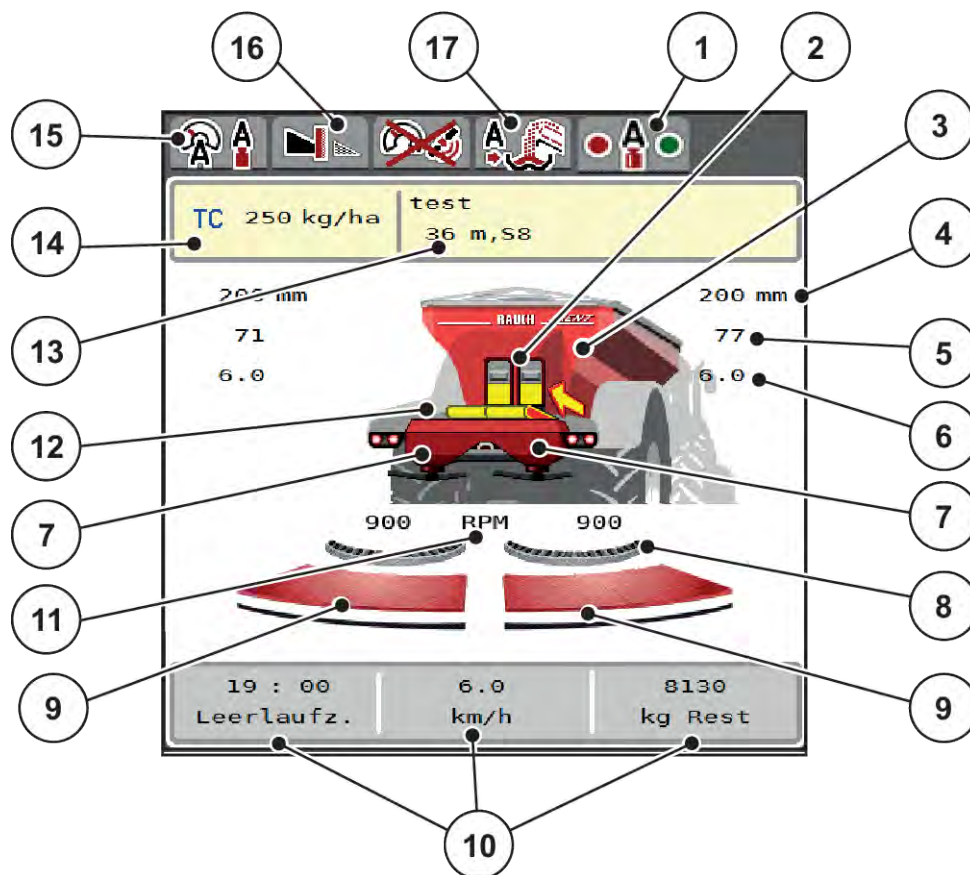

Fig. 1: Machine control unit display

- |   |  |
|---|--|
| [1] EMC-Status  | [11] Spreading disc speed, right/left  |
| [2] Right/left pre-metering slide display                     | [12] Conveyor belt display   |
| [3] Large area spreader filling level display                 | [13] Fertilizer information display (fertilizer name, working width and spreading disc type)<br>Button: Adjustment in the fertilizer chart |
| [4] Current opening position of left/right pre-metering slide | [14] Current application rate from the fertilizer settings or the task controller<br>Button: direct entry of the application rate          |
| [5] Quantity change, right/left                               | [15] Selected operating mode   |
| [6] Drop point position, right/left                           | [16] Boundary spreading mode   |
| [7] Left/right spreading unit filling level display           | [17] Overloading operating mode display  |
| [8] AXMAT- Function is active                                 |  |
| [9] Metering slide opening status, right/left                 |  |
| [10] Freely definable display fields                          |  |

### 2.1.2 Display fields

The three display fields in the operating screen can be individually adjusted and assigned the following values as desired:

- Forward speed
- Flow factor (FF)
- ha trip
- kg trip
- m trip
- kg left
- m left
- ha left
- Idle time (Time until the next idle measurement)
- Torque for the spreading disc drive
- Belt speed in mm/s

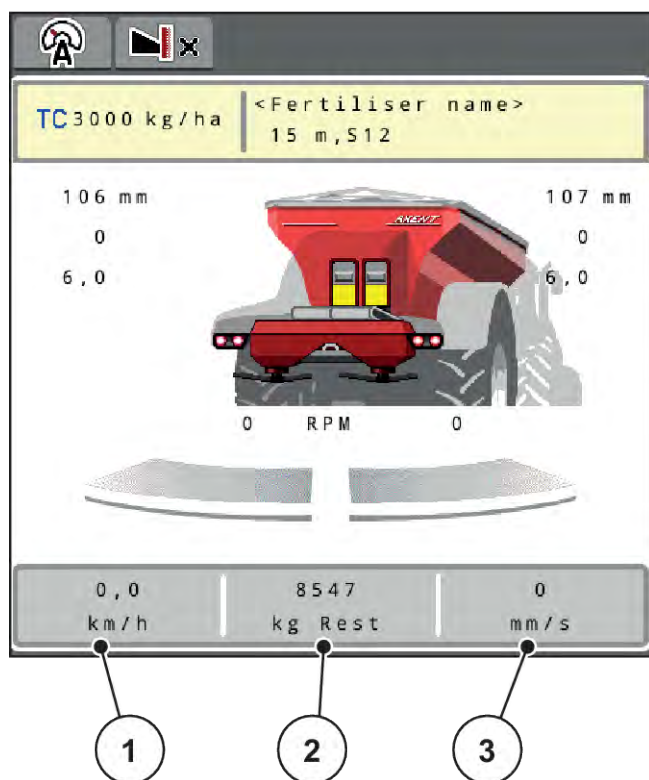

Fig. 2: Display fields

[1] Display field 1

[3] Display field 3

[2] Display field 2

### Select display

- ▶ Press the corresponding display field in the touch screen.

*The available options are displayed in a list.*

- ▶ Select the new value to be assigned to the display field.

- ▶ Press the OK button.

*The operating screen is displayed.*

*The respective display field displays the new value.*

### 2.1.3 Display of the metering slide status

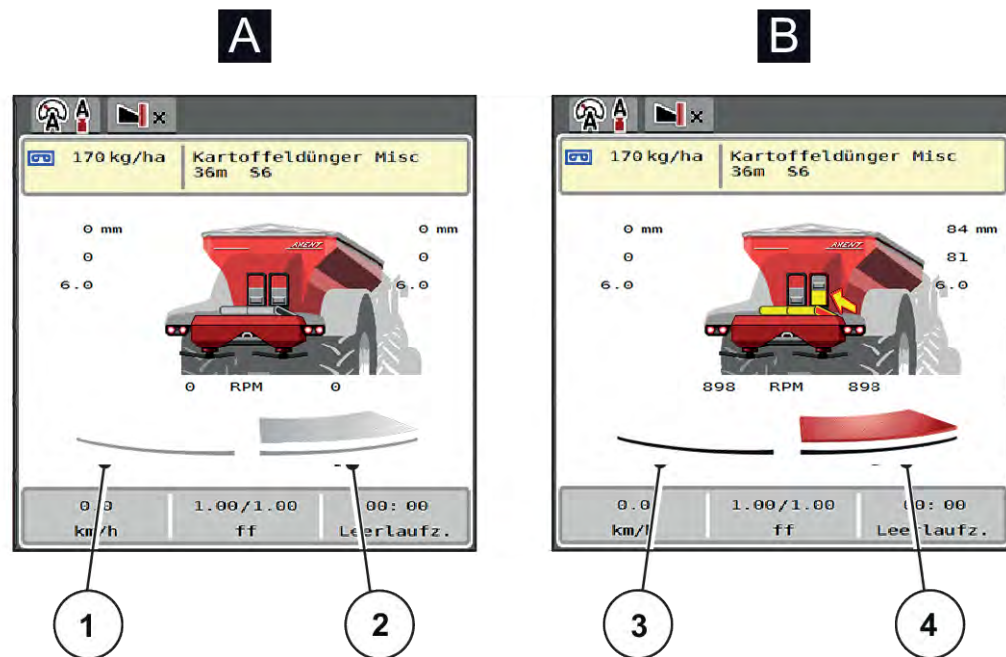

Fig. 3: Display of the metering slide status

[A] Spreading operation inactive

[1] Section deactivated

[2] Section activated

[B] Machine in spreading operation

[3] Section deactivated

[4] Section activated



In boundary spreading mode, you can **immediately deactivate an entire spreading side**. This is particularly helpful for a quick spreading operation in field corners.

- ▶ Press the softkey section reduction longer than 500 ms.

### 2.1.4 Display of sections

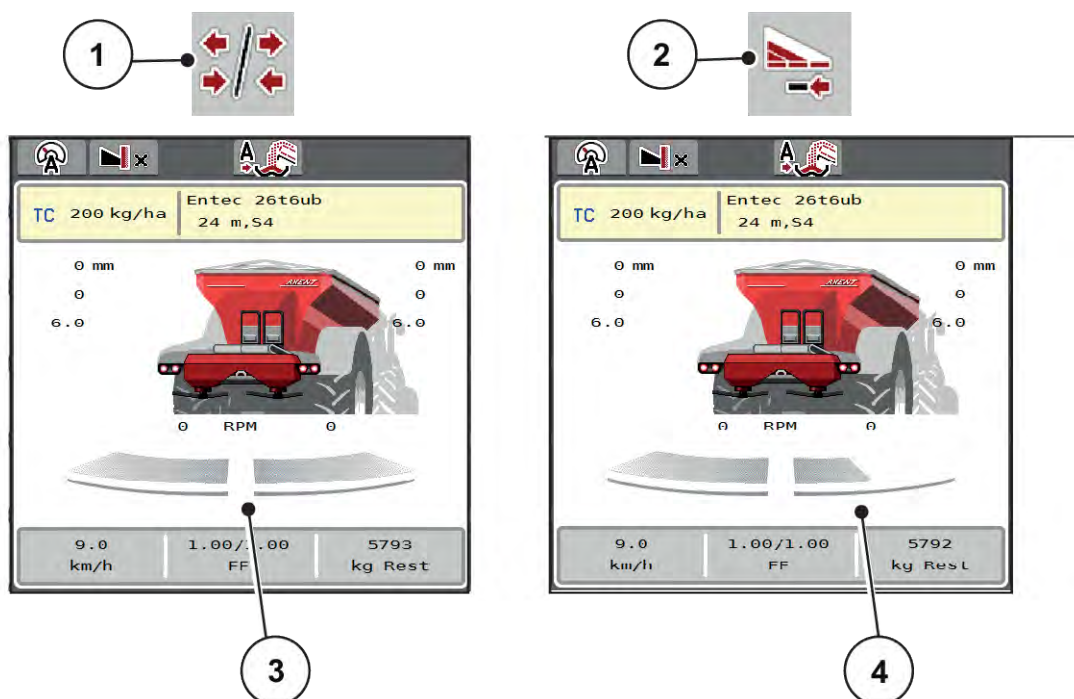

Fig. 4: Display of the section states

- [1] Section/boundary spreading toggle key
- [2] Reduce right section button
- [3] Activated sections on entire working width
- [4] Right section is reduced by several partial sections

Further display and setting options are explained in chapter 5.2.1 Working with sections.



We recommend restarting the terminal in the following cases:

- You have changed the working width.
- You have opened a different fertilizer chart entry.

After restarting the terminal, the section display changes to match the new settings.

### 2.1.5 Display of the EMC status



Status of the EMC control:







- Red dot: EMC control inactive
- Green dot: EMC control active

When side/limited border spreading, no EMC control is active on the side/limited border spreading side, which is why the dot remains red on the corresponding side.











## 2.2 Library of icons used

The AXENT ISOBUS machine control unit displays icons for the individual menus and functions on the screen.





### 2.2.1 Navigation

Icon	Meaning
	Go to the left; previous page
	Go to the right; next page
	Back to the previous menu
	Back to main menu
	Switch between working screen and menu window
	Acknowledgment of warning messages
	Cancellation, closing the dialog window













## 2.2.2 Menus

Icon	Meaning
	Switch from a menu window directly to the main menu
	Switch between working screen and menu window
	SpreadLight operating lights
	Hopper cover
	Fertilizer settings
	Machine settings
	Fast emptying
	System/Test
	Information
	Weighing/Trip counter





## 2.2.3 Working screen icons

Icon	Meaning
	Start spreading and control of application rate
	The spreading operation has started; stop the application rate regulation
	Start spreading discs
	Rotate the spreading discs; stop the spreading discs

























Icon	Meaning
	Reset the quantity adjustment to the pre-set application rate
	Switch between working screen and menu window
	Switch between boundary spreading and sections on the left, right or both spreading sides
	Sections on the left side, boundary spreading on the right spreading side
	Sections on the right side, boundary spreading on the left spreading side
	Boundary spreading on the left, right or both spreading sides
	OptiPoint Pro active OptiPoint Pro not active: the symbol is not shown
	Headland mode active
	Selection of the surplus/shortage quantity on the left, right or both spreading sides (%)
	Quantity adjustment + (plus)
	Quantity adjustment - (minus)
	Quantity adjustment, left + (plus)
	Quantity adjustment, left - (minus)



Icon	Meaning
	Quantity adjustment, right + (plus)
	Quantity adjustment, right - (minus)
	Manual quantity adjustment + (plus)
	Manual quantity adjustment - (minus)
	Increasing the spreading disc speed (plus)
	Reducing the spreading disc speed (minus)
	Left spreading side inactive
	Left spreading side active
	Right spreading side inactive
	Right spreading side active
	Reduce left section (minus) <b>In boundary spreading mode:</b> Pressing and holding (> 500 ms) immediately deactivates an entire spreading side.
	Increase left section (plus)
	Reduce section, right (minus) <b>In boundary spreading mode:</b> Pressing and holding (> 500 ms) immediately deactivates an entire spreading side.

Icon	Meaning
	Increase right section (plus)
	Activate right boundary spreading function/TELIMAT
	Right boundary spreading function/TELIMAT active
	Activate left boundary spreading function
	Left boundary spreading function active

#### 2.2.4 Other icons

Icon	Meaning
	Start idle measurement, in the main menu
	Limited border spreading mode, in the working screen
	Full border spreading mode, in the working screen
	OptiPoint Pro active OptiPoint Pro not active: the symbol is not shown
	Headland mode active
	Limited border spreading mode, in the main menu
	Full border spreading mode, in the main menu

Icon	Meaning
	Manual overloading is active
	Automatic overloading is active
	Operating mode AUTO km/h + AUTO kg
	Working mode AUTO km/h
	Operating mode MAN km/h
	Operating mode MAN scale
	Warning symbol: The safety hood is open
	Start manual overloading
	Manual overloading is active; stop manual overloading
	Increase + (plus) pre-metering slide opening
	Decrease – (minus) pre-metering slide opening
	Decrease (minus) conveyor belt speed; Terminals with 2x6 function keys only
	Increase (plus) conveyor belt speed; Terminals with 2x6 function keys only
	EMC control deactivated
	Status EMC
	Loss of the GPS signal (GPS J1939)

Icon	Meaning
	The minimum mass flow is undercut
	The maximum mass flow is exceeded.

### 2.3 Structural menu overview

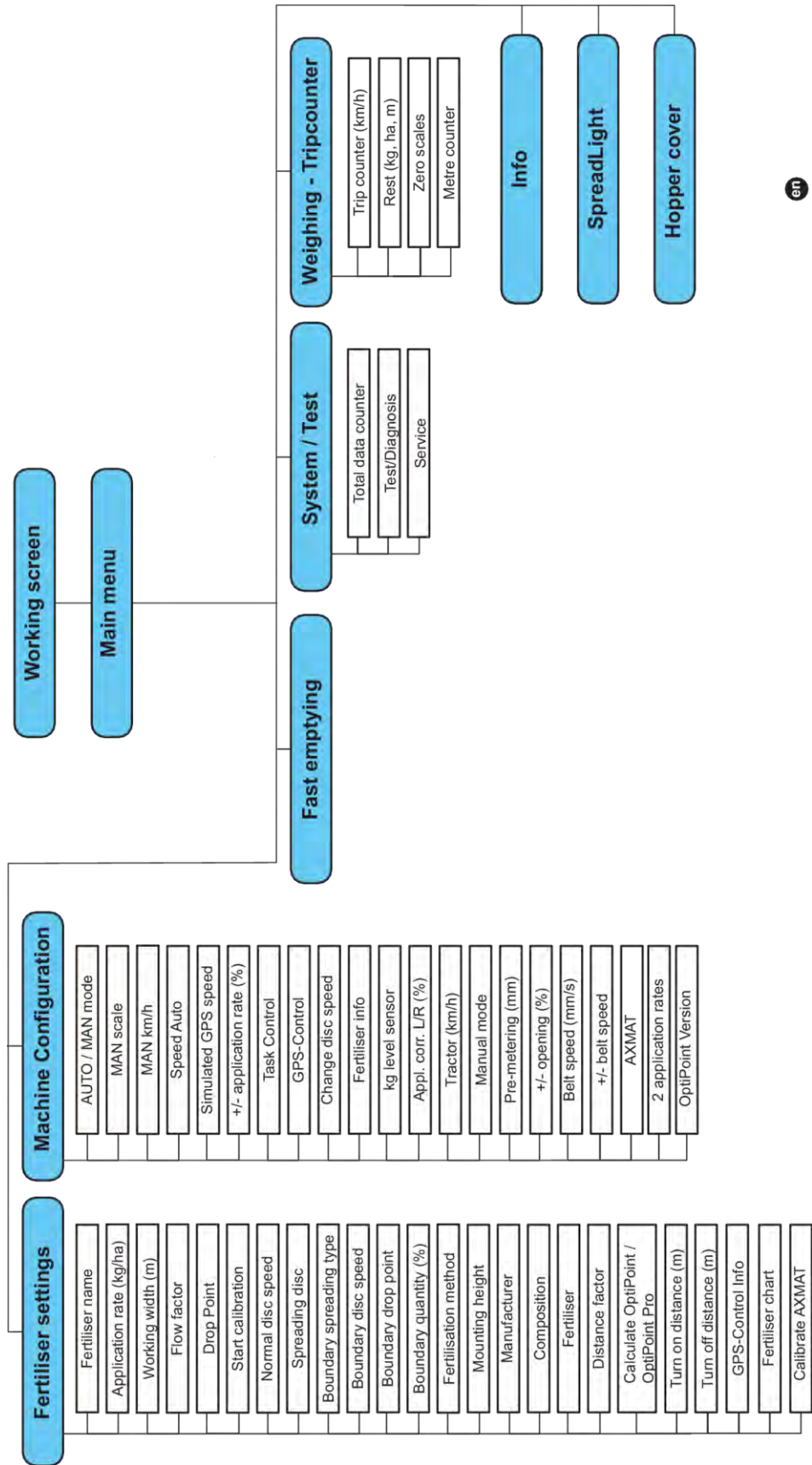

en

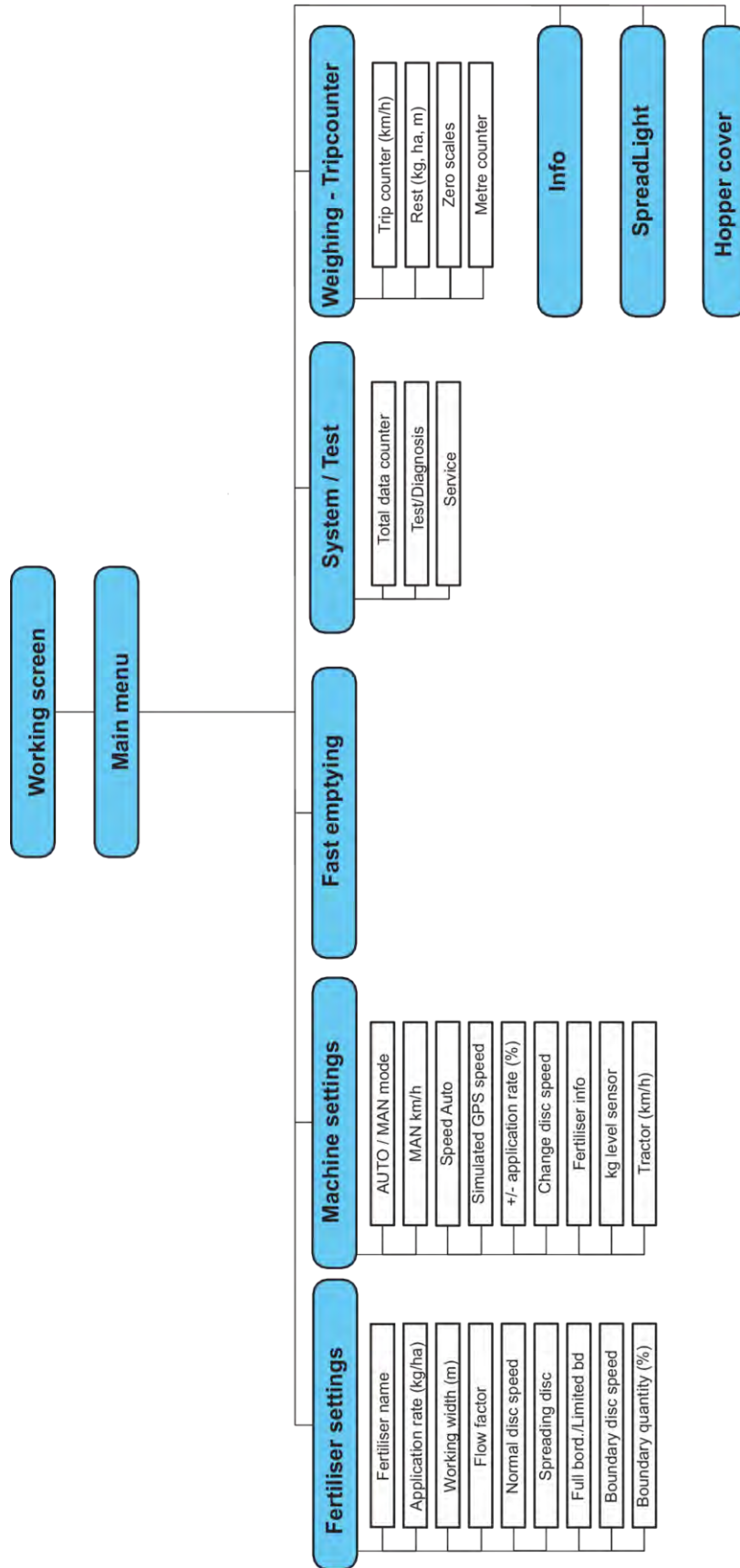

## 3 Attachment and installation

### 3.1 Tractor requirements

Before installing the machine control unit, ensure that your tractor meets the following requirements:

- A minimum voltage of **11 V** must **always** be guaranteed, even if multiple loads are connected simultaneously (e.g., air conditioning system, lights)
- The PTO speed can be set to 1000 rpm and has to be complied with.



On tractors without load-switchable transmission, the forward speed must be selected by using the correct gear ratio in such a way that it corresponds to a PTO speed of **1,000 rpm**.

- 9-pin socket (ISO 11783) located at the rear of the tractor, for connecting the machine control unit to the ISOBUS
- 9-pin terminal plug (ISO 11783) for connecting an ISOBUS terminal to the ISOBUS

The power supply of the machine control unit is implemented via the 9-pin ISOBUS socket at the rear of the tractor.



If the tractor is not equipped with a 9-pin socket at the rear, a tractor assembly set including a 9-pin socket for the tractor (ISO 11783) and a forward speed sensor may be purchased additionally as special equipment.

- The tractor has to provide the speed signal to the ISOBUS.



Check with your dealer that your tractor is equipped with the required connections and sockets.

- Due to the numerous configurations of tractor/machine/terminal, please contact your dealer for selecting the correct connection.

### 3.2 Connections, sockets

#### 3.2.1 Power supply

The power supply of the machine control unit is implemented via the 9-pin socket at the rear of the tractor.

#### 3.2.2 Connecting the machine control unit

Depending on the equipment, there are different methods for connecting the machine control unit to the mineral fertilizer spreader. Further information can be obtained from the operator's manual of your machine.



### 3.2.3 Overview of actuators and sensors



The following overviews do not represent the exact position of actuators and sensors on the machine. This sub-chapter only serves for information on the assemblies and sensors controlled by the electronic system.

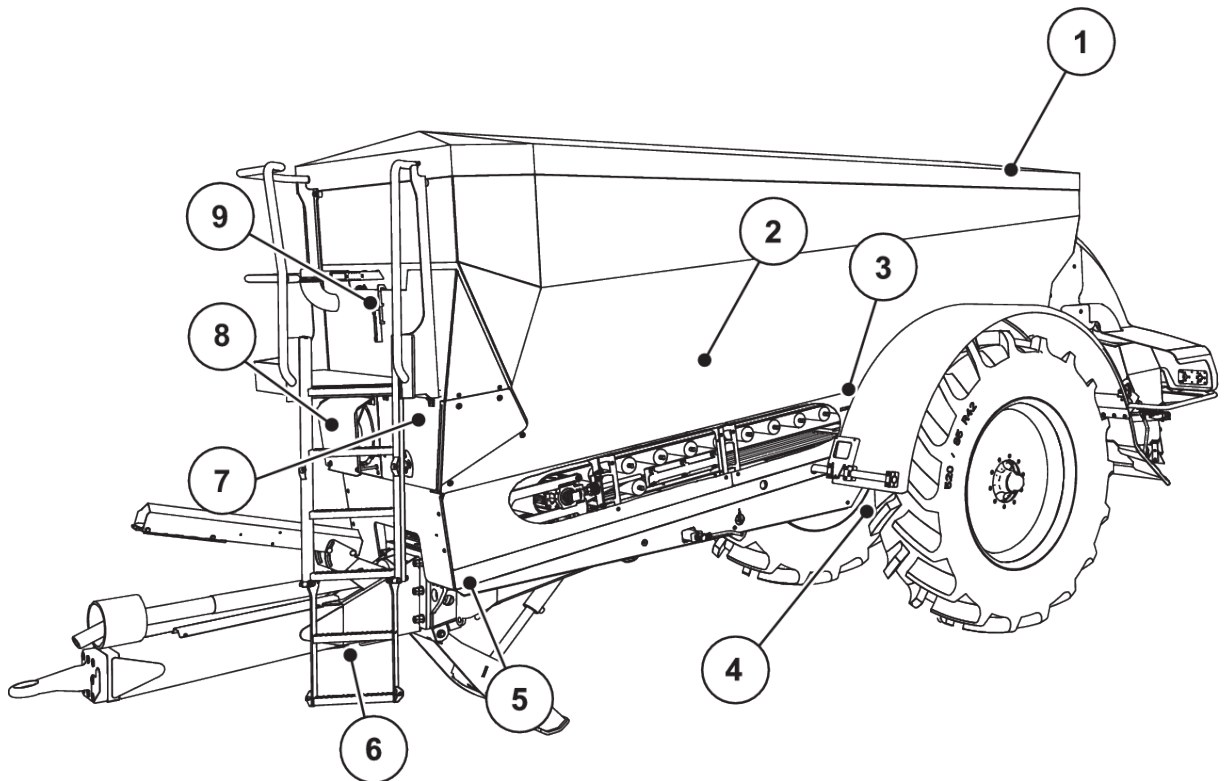

Fig. 5: Overview of actuators and sensors at the AXENT large area spreader

- |   |                                       |
|---|---------------------------------------|
| [1] Hopper cover                        | [5] Front weigh cells, left/right     |
| [2] Level sensor                        | [6] Towing bar angle sensor           |
| [3] Vibrator (optional)                 | [7] Hydraulic block with valves       |
| [4] Axis angle sensor                   | [8] Oil temperature sensor            |
| Rear weigh cells, left/right            | Oil chiller                           |
| Steering cylinder (optional)            | [9] Hydraulic circuit floating switch |
| Steering axle A/B stop valve (optional) |                                       |

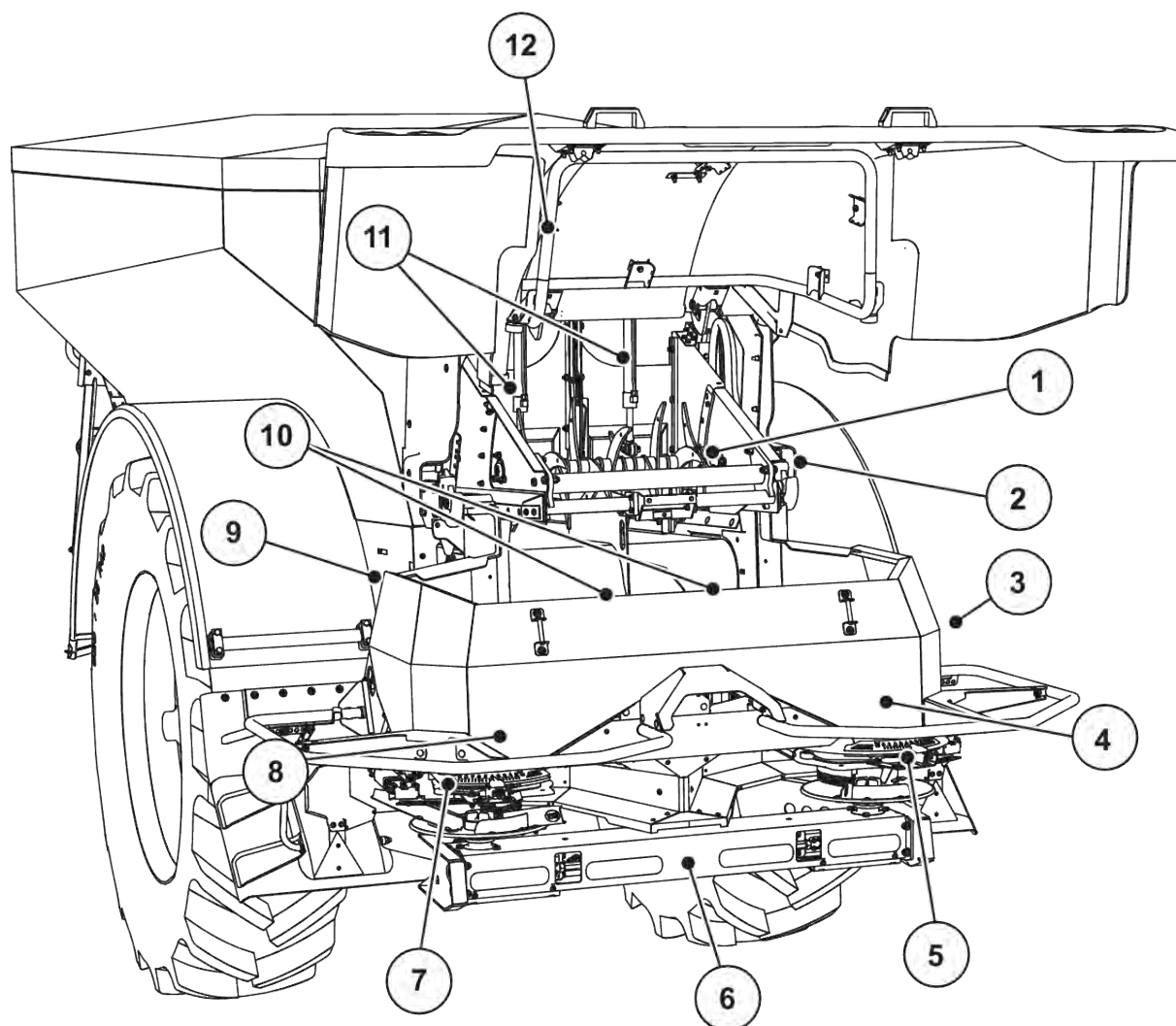

Fig. 6: Overview of actuators and sensors on the AXENT large area spreader and AXIS-PowerPack fertilizer spreading unit

- |   |   |
|---|---|
| [1] Comb roller                               | [7] Drop point actuator, left               |
| [2] Belt drive                                | [8] Dosing slider actuator, left            |
| Belt speed sensor                             | Left agitator                               |
| [3] Forward speed sensor (at right wheel)     | [9] Interface connector for spreading units |
| [4] Metering slide actuator, right            | [10] Ultrasonic sensors                     |
| Right agitator                                | [11] Pre-metering slide hydraulic cylinder  |
| [5] Drop point actuator, right                | [12] Safety hood switch                     |
| [6] FAG sensor in hydraulic motor, left/right |   |

The UNIVERSAL PowerPack is equipped with the following actuators and sensors:

- Hydraulic motor pressure sensors (left/right and return)
- Speed sensor left/right for spreading discs

### 3.2.4 Metering slide preparation

- *only AXIS-PowerPack*

The machine has an electronic slide actuator to set the application rate.



Please observe the operator's manual for your machine.

## 4 Operation

### ⚠ CAUTION!

#### Risk of injury due to discharged fertilizer

In the case of a fault, it is possible that the metering slide unexpectedly opens during road transport to the spreading location. There is a risk of slipping and personal injury due to ejected fertilizer.

- ▶ **Before leaving for the spreading location**, always switch off the electronic machine control unit.

### 4.1 Switching on the machine control unit

#### Requirements:

- The machine control unit is correctly connected to the machine and the tractor.
  - For an example, see Chapter 3.2.2 *Connecting the machine control unit*.
- The minimum voltage of **11 V** is required.

- ▶ Start the machine control unit.

*After a few seconds, the **start-up screen** of the machine control unit is displayed.*

*Subsequently, the machine control unit displays the **activation menu** for a few seconds.*

- ▶ Press the enter key.

*The working screen then appears.*



#### ■ **Requesting the condition of the safety hood**

The safety hood is important safety equipment for safe machine operation. Overloading cannot be realized if the safety hood is open.

The safety hood is equipped with a switch. The switch reports the open or closed position of the safety hood to the machine control unit. If the safety hood is open, all actuators controlled via the machine control unit are stopped (conveyor belt, pre-metering slide, comb roller, hopper cover).



If the safety hood is open, an error message is displayed. See 7.1 *Meaning of the alarm messages*.

- All outputs are de-energized; all functions are deactivated.

- ▶ Close safety hood.

▷ Please refer to the operator's manual of the machine.



- ▶ Press ACK.  
*The alarm message is acknowledged and disappears.*



As long as the safety hood is open, the warning symbol is displayed in the top of the operating screen.

## 4.2 Navigation within the menus



Please refer to chapter 1.3.4 *Menu hierarchy, keys and navigation* for important notes regarding the display and navigation between menus.

Accessing menus and menu entries **by touching the touch screen or pressing the function keys** is described below.

- For additional information, refer the operator's manual of the terminal used.

### ■ **Accessing the main menu**



- ▶ Press the **Working screen/main menu** function key. See 2.2.2 *Menus*.

*The main menu is displayed.*

### Accessing the sub-menu via the touch screen

- ▶ Press the button of the desired sub-menu.

Windows appear with prompts for various actions.

- Text input
- Value input
- Settings made in further sub-menus



Not all parameters are displayed simultaneously on one screen. You can switch to the next or previous menu windows (tabs) using the **left/right arrow** keys.

### ■ **Exiting menus**



- ▶ Confirm settings by pressing the **Return** key.

*You will return to the previous menu.*



- ▶ Press the **Working screen/main menu** key.

*You will return to the working screen.*



► Press **ESC**.

*The previous settings are retained.*

*You will return to the previous menu.*

## 4.3 Functional description: Status indicator

The control unit provides information on the current filling levels and sensor conditions of the large area spreader and the attached AXIS-PowerPack or UNIVERSAL-PowerPack.spreading unit

### 4.3.1 Spreading material supply

The AXENT conveyor belt is started up when the AXENT pre-metering slides are opened. The spreading material is discharged through the outlet into the AXIS-PowerPack or UNIVERSAL-PowerPack spreading unit.

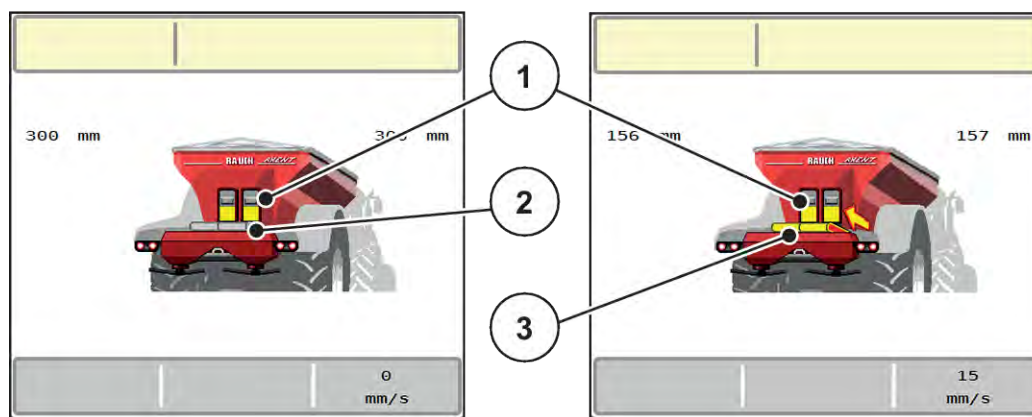

Fig. 7: Open pre-metering slide display

[1] Open pre-metering slide

[2] Standing conveyor belt

[3] Running conveyor belt

#### AXIS-PowerPack

The spreader material flowing in fills the intermediate container in the AXIS-PowerPack. The overload runs continuously depending on the spread quantity. The belt speed and pre-metering setting are automatically adjusted.

#### UNIVERSAL PowerPack

The spreading material (lime) falls from the conveyor belt directly on to the spreading discs.

### 4.3.2 Empty hopper



The filling level sensor does not have a function if the kg level sensor is active.

- See 4.7 Machine settings

The filling level sensor for the AXENT hopper is not at the hopper base.

At the time of empty notification, the remaining spreading material in the hopper is usually sufficient for a few overloading operations.

Despite the alarm message, the AXENT ISOBUS machine control unit attempts full overloading of the residual quantity.

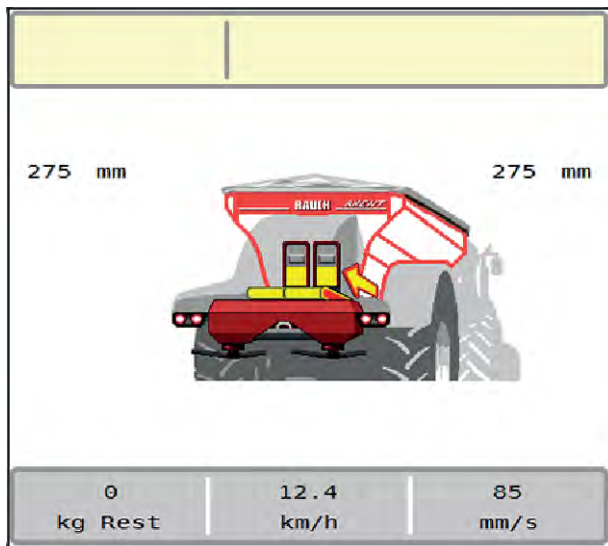

Fig. 8: AXENT hopper filling level indicator

## 4.4 Main menu

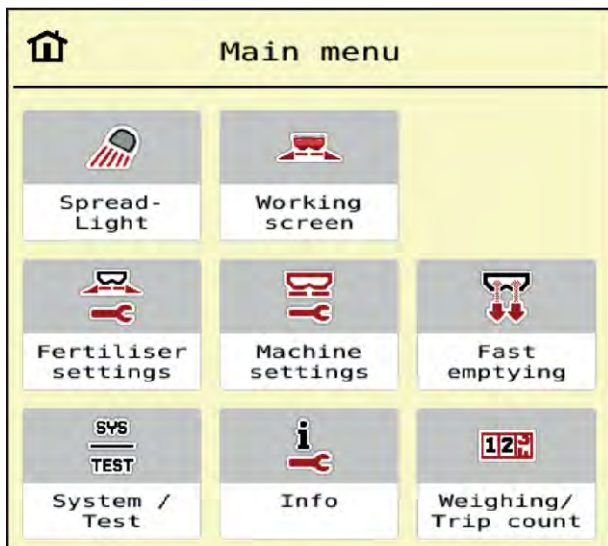

Fig. 9: Main menu with sub-menus

Sub-menu	Meaning	Description
SpreadLight	Activation/deactivation of operating lights	4.12 <i>Operating lights (SpreadLight)</i>
Working screen	Switches to the working screen	
Fertiliser settings	Fertilizer and spreading operation settings	4.5 <i>Fertilizer settings</i>
Machine settings	Tractor and machine settings	4.7 <i>Machine settings</i>
Fast emptying	Direct access to menu for fast emptying of the machine	4.8 <i>Fast emptying</i>
System / Test	Settings and diagnosis of the machine control unit	4.9 <i>System/Test</i>
Info	Machine configuration display	4.10 <i>Info</i>
Weighing/Trip count.	Values regarding spreading work carried out and functions for weighing operation	4.11 <i>Weighing/Trip counter</i>

In addition to the sub-menus, you can select function keys in the main menu.

- See 2.2.4 *Other icons*.

## 4.5 Fertilizer settings



The machine control unit automatically detects the attached spreading unit after connecting the ISOBUS connector to the AXENT large area spreader.

Some menu entries differ depending on whether the AXIS-PowerPack fertilizer spreading unit or the UNIVERSAL-PowerPack lime spreading unit is attached.



In this menu, the fertilizer and spreading settings can be changed.

- ▶ Access the menu Main menu > Fertiliser settings.



Not all parameters are displayed simultaneously on one screen. You can switch to the next or previous menu windows (tabs) using the **left/right arrow** keys.



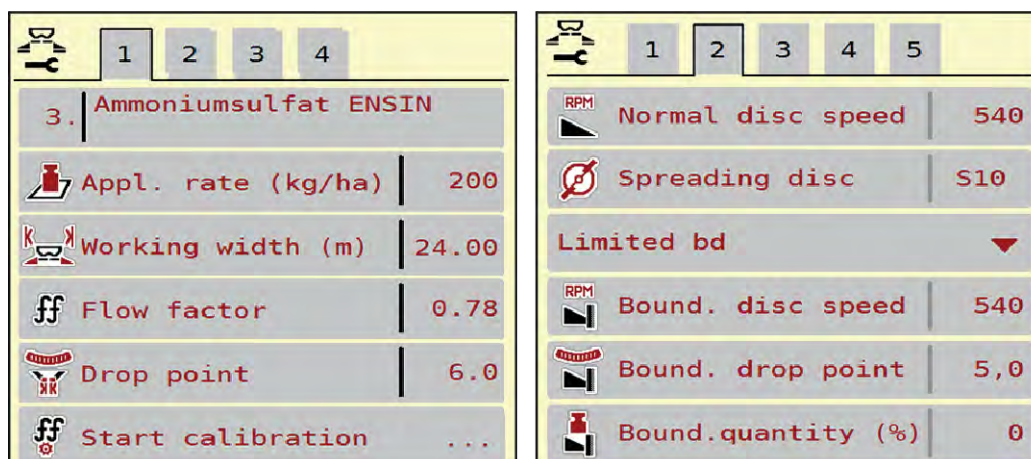

Fig. 10: Fertiliser settings menu, tab 1 and 2

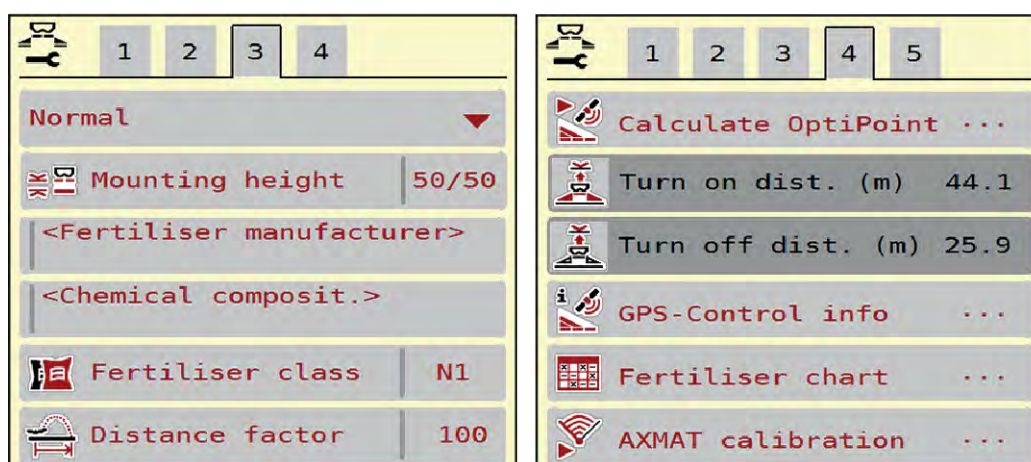

Fig. 11: Fertiliser settings menu, tab 3 and 4

Sub-menu	Meaning	Description
Fertiliser name	Fertilizer selected from the fertilizer chart	4.5.13 Fertilizer charts
Appl. rate (kg/ha)	Input of target value for the application rate in kg/ha	4.5.1 Application rate
Working width (m)	Determination of the working width to be spread	4.5.2 Setting the working width
Flow factor	Input of flow factor of the fertilizer used	4.5.3 Flow factor
Drop point	Input of the drop point For <b>AXIS with electrical drop point actuators</b> : Drop point adjustment	Please observe the operator's manual for the machine. 4.5.4 Drop point

Sub-menu	Meaning	Description
Start calibration	Accessing the sub-menu for executing the calibration	<i>4.5.5 Calibration test</i>
Normal disc speed	Input of the desired spreading disc speed Influences the EMC mass flow control	<i>4.5.7 Rotation speed</i>
Spreading disc	Setting of the disc type mounted on the AXIS-PowerPack The setting influences the EMC mass flow control. Note: Spreading disc U2 is for use only on the UNIVERSAL PowerPack	Selection list: <ul style="list-style-type: none"> <li>• S1</li> <li>• S4</li> <li>• S6</li> <li>• S8</li> <li>• S10</li> <li>• S12</li> </ul>
Bound. sprd.type	Selection list: <ul style="list-style-type: none"> <li>• Limited bd</li> <li>• Full bord.</li> </ul>	Selection with arrow keys, confirmation with the Enter key
Bound. disc speed	Pre-setting the RPM in the boundary spreading mode	To be entered in a separate input window
Bound. drop point	Pre-setting the drop point in the boundary spreading mode	To be entered in a separate input window
Limit. bd rate (%)	Pre-setting the application rate reduction in boundary spreading mode	To be entered in a separate input window
Fertilisation method	Selection list: <ul style="list-style-type: none"> <li>• Normal</li> <li>• Late sprd.</li> </ul>	Selection with <b>arrow keys</b> Confirmation with the <b>Enter key</b>
Mounting height	No function	
Manufacturer	Fertilizer manufacturer input	
Composition	Percentage of the chemical composition	
Fertilizer class	Selection list	Selection with arrow keys; Confirmation with the Enter key
Distance factor	Input of the distance factor from the fertilizer chart. Required for OptiPoint calculation	
Calculate OptiPoint	Input of the GPS control parameters	<i>4.5.10 Calculate OptiPoint / OptiPoint Pro</i>
Turn on dist. (m)	Input of turn on distance	

Sub-menu	Meaning	Description
Turn off dist. (m)	Input of turn off distance	
GPS-Control info	Display of information of the GPS Control parameters	<i>4.5.12 GPS Control info</i>
Fertiliser chart	Management of fertilizer charts	<i>4.5.13 Fertilizer charts</i>
Calibrate AXMAT	<b>AXIS-H 50.2 only</b> Open the sub-menu for calibration of the AXMAT function	Please observe the operator's manual for the special equipment

### 4.5.1 Application rate



In this menu, you can enter the target value for the desired application rate.

#### Entering the application rate:

- ▶ Access the menu Fertiliser settings > Appl. rate (kg/ha).  
*The currently applied application rate is displayed.*
- ▶ Enter the new value in the input field.
- ▶ Press **OK**.  
*The new value is saved in the machine control unit.*

You can also enter or adjust the application rate directly via the working screen.

- ▶ Press the Appl. rate (kg/ha) [1] button on the touch screen.

*The number input window is displayed.*

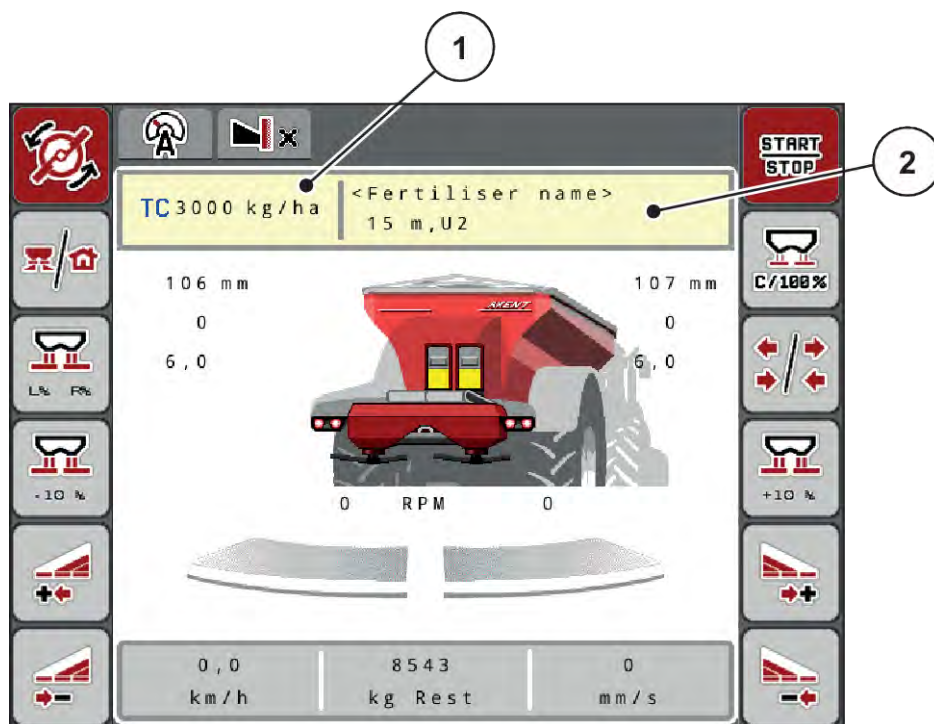

Fig. 12: Entering the application rate on the touch screen

[1] Button Application rate

[2] Button Fertiliser chart

- ▶ Enter the new value in the input field.

- ▶ Press **OK**.

*The new value is saved in the machine control unit.*

#### 4.5.2 Setting the working width



You can set the working width (in meters) in this menu.

- ▶ Access the menu Fertiliser settings > Working width (m).

*The **currently applied** working width is displayed.*

- ▶ Enter the new value in the input field.

- ▶ Press **OK**.

*The new value is saved in the machine control unit.*



The working width cannot be adjusted whilst spreading is in progress.

### 4.5.3 Flow factor



The flow factor lies within the range of **0.2** to **1.9**.

With identical basic settings (km/h, working width, kg/ha), the following applies:

- If the flow factor is **increased**, the dosing quantity is **reduced**
- If the flow factor is **reduced**, the dosing quantity is **increased**

An error message is displayed if the flow factor is outside the preset range. See chapter 7 *Alarm messages and possible causes*.

If you are spreading organic fertilizer or rice, you need to reduce the minimum factor to 0.2. Otherwise the error message will be displayed constantly.

If you have obtained the flow factor from earlier calibrations or from the fertilizer chart, enter it manually in this selection window.



Via the Start calibration menu, the flow factor can be determined and entered using the control unit. Refer to Chapter 4.5.5 *Calibration test*

The flow factor on the AXIS PowerPack with EMC is determined by the EMC mass flow controller. However, it may also be entered manually.



The flow factor calculation depends on the operating mode used. For further information about the flow factor, refer to chapter 4.7.1 *AUTO/MAN mode*.

#### Entering the flow factor:

- ▶ Access the menu Fertiliser settings > Flow factor.  
*The currently set flow factor is displayed.*
- ▶ Enter the value obtained from the fertilizer chart into the input field.



If your fertilizer is not listed in the fertilizer chart, enter a flow factor of **1.00**.  
In the AUTO km/h operating mode, we highly recommend executing a **calibration** in order to be able to accurately determine the flow factor for this fertilizer.

- ▶ Press OK.

*The new value is saved in the machine control unit.*



For the AXIS-PowerPack EMC (AUTO km/h + AUTO kg operating mode), we recommend that the flow factor is displayed on the working screen. This allows you to monitor the regulation of the flow factor during spreading. See chapter 2.1.2 *Display fields*.

#### 4.5.4 Drop point



With the AXIS EMC mineral fertilizer spreader, the drop point is set via the electrical drop point adjustment exclusively.

- ▶ Access the menu Fertiliser settings > Drop point.
- ▶ Determine the position for the drop point using the fertilizer chart.
- ▶ Enter the determined value in the input field.
- ▶ Press OK.

*The Fertiliser settings window appears with the new drop point.*

If the drop point is blocked, alarm 17 is displayed; refer to chapter 7 *Alarm messages and possible causes*.

#### ⚠ CAUTION!

##### Risk of injury due to automatic adjustment of the drop point

When the **Start/Stop** function key is pressed, the drop point is automatically moved to the preset value by an electrical actuator (Speedservo). This may cause injury.

- ▶ Before pressing the **Start/Stop** key, ensure that nobody is present in the hazard zone of the machine.
- ▶ Acknowledge the "Approach drop point" alarm message by pressing Start/Stop.

#### 4.5.5 Calibration test

#### ⚠ WARNING!

##### Risk of injury during calibration test

Rotating machine parts and discharged fertilizer could cause injury.

- ▶ Before starting the calibration, ensure that all requirements have been met.
- ▶ Observe the calibration chapter in the operator's manual for the machine.



The Start calibration menu is locked for weighing spreaders and all machines in the **operating mode** AUTO km/h + AUTO kg. This menu item is inactive.

In this menu, the flow factor can be determined based on a calibration test and saved in the machine control unit.

Execute the calibration:

- Before spreading for the first time
- If the fertilizer quality has changed significantly (moisture, high dust content, granulate damage)
- If a new fertilizer type is used

The calibration must either be conducted with a running PTO at a standstill or while driving over a test section.

- Remove both spreading discs.
- Move the drop point to the calibration position (value 0).

#### Entering the working speed:

- ▶ Access the menu Fertiliser settings > Start calibration.
- ▶ Enter the average working speed.  
This value is required for calculation of the slider position during calibration.
- ▶ Press the Continue button.  
*The new value is saved in the machine control unit.*

*The second calibration page is displayed.*



#### Select the section

- ▶ Set the spreader side on which the calibration is to be carried out.  
Press the function key of the left spreading side.  
Press the function key of the right spreading side.  
*The icon indicating the selected spreader side has a red background.*



- ▶ Press **Start/Stop**.

*The metering slider of the previously selected section opens and the calibration is started.*



The calibration can be stopped at any time by pressing the ESC key. The metering slide is closed and the display shows the Fertiliser settings menu.



The calibration time is not relevant to the accuracy of the results. However, a **minimum of 20 kg** should be calibrated.

- ▶ Press **Start/Stop** again.

*The calibration is completed.*

*The metering slider closes.*

*The third calibration page is displayed.*

#### ■ **Calculating the new flow factor**

#### **WARNING!**

##### **Risk of injury due to rotating machine parts**

Any contact with rotating machine parts (drive shaft, hubs) may lead to bruises, abrasions, and crushing injuries. Body parts or objects may be caught or drawn in.

- ▶ Switch off the tractor engine.
- ▶ Switch off the hydraulics system and secure it against unauthorized activation.



- ▶ Weigh the collected weight (taking into account the empty weight of the collection tray).
- ▶ Enter the weight under the **Calibrated quantity** menu entry.
- ▶ Press **OK**.

*The new value is saved in the machine control unit.*

*The **Flow factor calculation** menu is displayed.*



The flow factor must be between 0.4 and 1.9.

- ▶ Set the flow factor.  
In order to apply the newly calculated flow factor, press the Confirm flow factor button.  
To confirm the previously saved flow factor, press the **ESC** key.

*The flow factor is saved.*

*The “Approach drop point” alarm message is displayed.*

#### **⚠ CAUTION!**

##### **Risk of injury due to automatic adjustment of the drop point**

When the **Start/Stop** function key is pressed, the drop point is automatically moved to the preset value by an electrical actuator (Speedservo). This may cause injury.

- ▶ Before pressing the **Start/Stop** key, ensure that nobody is present in the hazard zone of the machine.
- ▶ Acknowledge the “Approach drop point” alarm message by pressing Start/Stop.

### 4.5.6 Disc type



For optimal empty run measurement, check the correct input in the Fertiliser settings menu.

- The entries in the Spreading disc and Normal disc speed or PTO menu items must correspond to the actual settings of your machine.

The mounted spreading disc type has a default factory setting. If you have mounted different spreading discs on your machine, you must enter the correct type.

- ▶ Access the menu Fertiliser settings > Spreading disc.
- ▶ Activate the spreading disc type in the selection list.

*The Fertiliser settings window is displayed with the new spreading disc type.*

### 4.5.7 Rotation speed

#### ■ **Normal disc speed**



For optimal empty run measurement, check the correct input in the Fertiliser settings menu.

- The entries in the Spreading disc and Normal disc speed menu items must correspond to the actual settings of your machine.

The factory default speed is set to 750 rpm. If you want to set a different speed, you must change the saved value.

- ▶ Access the menu Fertiliser settings > Normal disc speed.
- ▶ Enter the speed value.

*The Fertiliser settings window is displayed with the new speed.*



Please observe Chapter 5.2.2 *Spreading with the automatic operating mode (AUTO km/h + AUTO kg)*.

## 4.5.8 Boundary spreading mode

### Only AXIS-PowerPack

this menu allows you to select a suitable spreading mode at the boundary of the field.

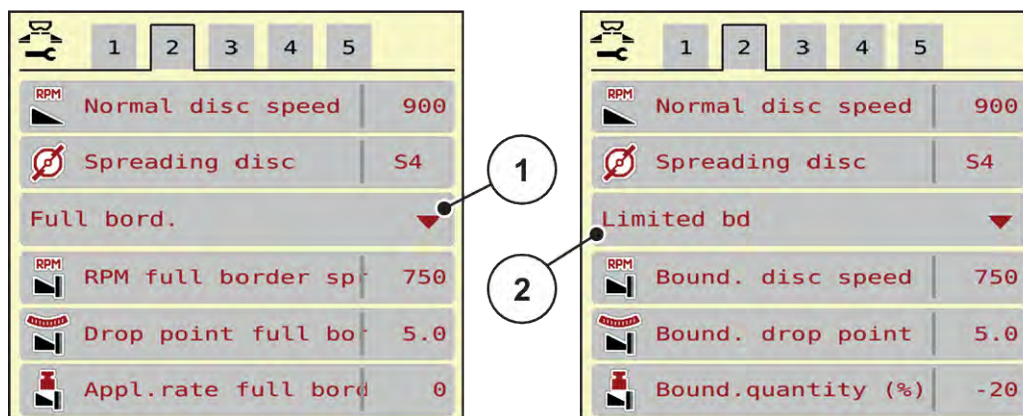

Fig. 13: Limited border spreading mode setting values

[1] Full border spreading

[2] Limited border spreading

- ▶ Access the menu Fertiliser settings.
- ▶ Switch to tab 2.
- ▶ Select limited border spreading mode Full bord. or Limited bd.
- ▶ If required, adjust the RPM, Drop point or quantity reduction in accordance with the information provided in the fertilizer chart.

## 4.5.9 Boundary spreading quantity



In this menu, you can reduce quantity value (as a percentage). This setting is used for the activation of the boundary spreading function and/or the TELIMAT unit (AXIS-M only).



We recommend reducing the quantity on the boundary spreading side by 20 %.

### Entering the boundary spreading quantity:

- ▶ Access the menu Fertiliser settings > Limit. bd rate (%).
- ▶ Enter the value in the input field and confirm.

*The Fertiliser settings window is displayed with the new boundary spreading quantity.*

### 4.5.10 Calculate OptiPoint / OptiPoint Pro



In the Calculate OptiPoint menu, you can enter the parameters to calculate the optimum turn-on and turn-off distances in the headlands. For an accurate calculation, it is very important to enter the distance factor for the fertilizer used.

The calculation should only be carried out after all the data for the desired spreading process has been transferred in the menu Fertiliser settings.



For the aerodynamic factor of the fertilizer used please refer to the fertilizer chart of the machine.

- ▶ Enter the required value in the menu Fertiliser settings > Distance factor.
- ▶ Access the menu Fertiliser settings > Calculate OptiPoint.

*The first page of the Calculate OptiPoint menu is displayed.*



The indicated forward speed refers to the forward speed in the area of the switching positions! See chapter 5.2.7 *GPS control*.

- ▶ Enter the average forward speed in the range of switching positions.
- ▶ Press OK.
- ▶ Press the Continue button.

*The third page of the menu is displayed.*

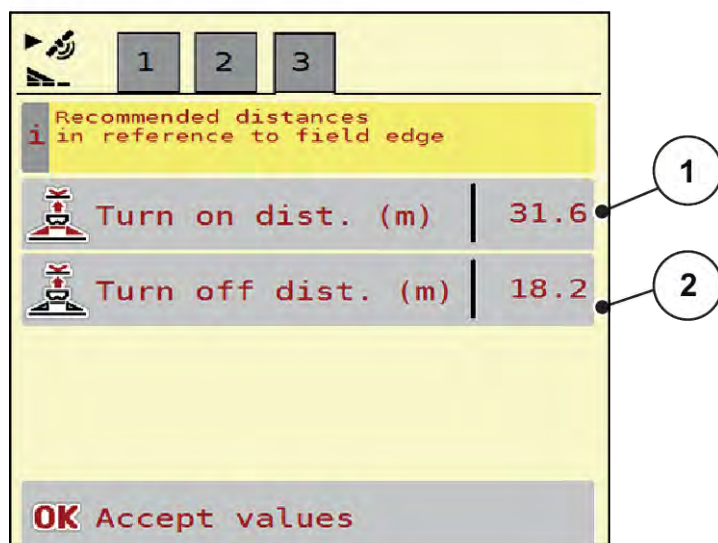

Fig. 14: Calculate OptiPoint, page 3

Number	Meaning	Description
[1]	Distance from the field border (in meters) at which the metering sliders open.	<i>Turn on distance (m)</i>
[2]	Distance from the field border (in meters) at which the metering sliders close.	<i>Turn off distance (m)</i>



On this page, you can manually adjust the parameters. See chapter 5.2.7 *GPS control*.

### Changing the values

- ▶ Open the desired list entry.
- ▶ Enter the new values.
- ▶ Press OK.
- ▶ Press the Accept values button.

*The OptiPoint is calculated.*

*The machine control unit switches to the GPS-Control info window.*

## 4.5.11

### Headland mode

Display of the OptiPoint Pro function:

- In the main menu: The "OPTI" function key appears in the main menu when the **OptiPoint Pro** function is activated in the machine settings.
- In the operating screen: The function key only appears in the operating screen when the side/limited border spreading function is activated.

**Activating the OptiPoint Pro function:**

- ▶ Press the “OPTI” function key to activate the headland mode.

*A message appears on the corresponding side (left or right) of the operating screen to indicate that the headland mode is active.*

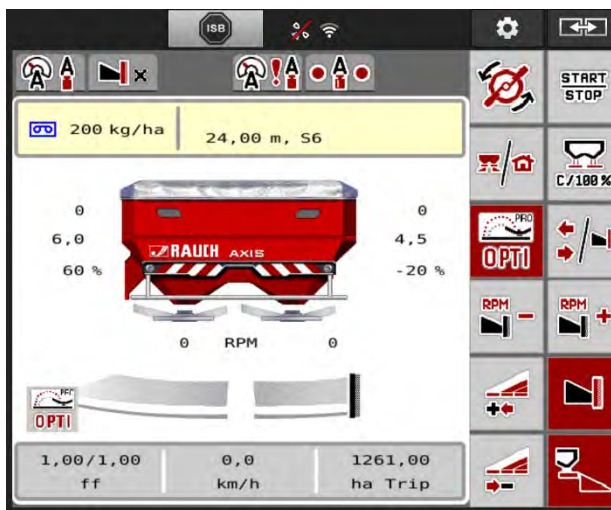

Fig. 15:

When the “OPTI” function key is activated, the rate and drop point increase on one side. The changed values are displayed on the operating screen. The extent to which the quantity and the drop point are increased depends on the fertilizer settings. In particular, with high working widths and drop points, there is also the possibility that activating the headland mode will cause no or only very slight changes in the fertilizer quantity and the drop point.

### ⚠ CAUTION!

#### Spreading errors possible

The “OPTI” function button for the headland mode must only be activated in the tracks on the headland, otherwise spreading errors may occur due to the changed fertilizer quantity and drop points.

The “OPTI” function button must only be activated in the red-marked areas, the headlands.

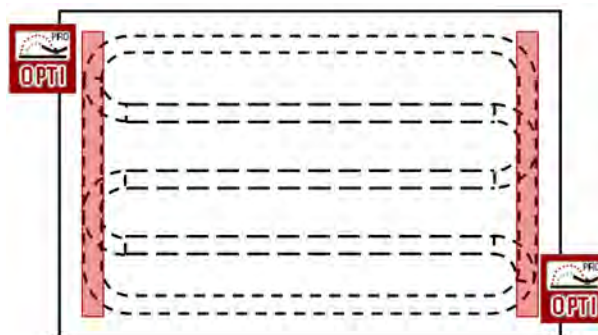

**Deactivating headland mode:**

- ▶ Press the “OPTI” function key again.

*The headland mode is deactivated.*

In addition, the headland mode is automatically deactivated in the following cases:

- Stopping the spreading process by pressing the START/STOP function key
- Pressing the ‘Switching sections/limited border spreading’ function key
- Pressing the ‘Limited border spreading function active’ function key

**4.5.12 GPS Control info**

The GPS-Control info menu informs you of the calculated setting values in the Calculate OptiPoint menu.

Depending on the terminal used, the display will show 2 distances (CCI, Müller Elektronik) or 1 distance and 2 time values (John Deere, etc.).

- With most ISOBUS terminals, the values displayed here are applied automatically to the corresponding settings menu of the GPS terminal.
- With some terminals, however, a manual entry is required.



This menu is for information purposes only.

- See the operating manual for your GPS terminal.

- ▶ Access the menu Fertiliser settings > GPS-Control info.

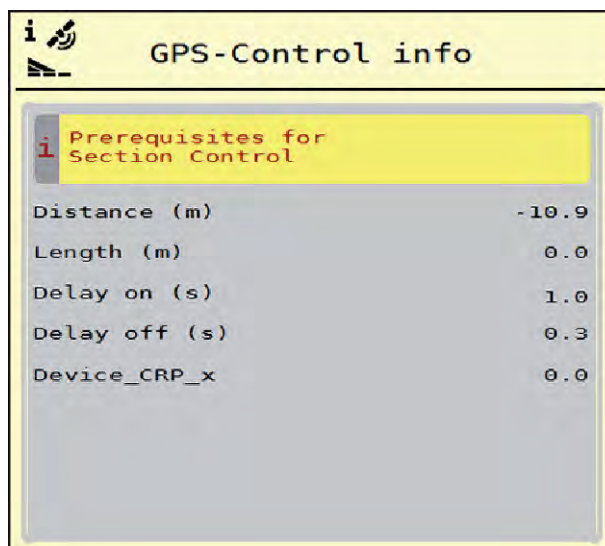

Fig. 16: Menu GPS-Control info

### 4.5.13 Fertilizer charts



In this menu, you can create and manage your own fertilizer charts.



Selecting a fertilizer chart affects the machine, fertilizer settings and the machine control unit. The set application rate is overwritten by the stored value from the fertilizer chart.



You will be able to automatically manage fertilizer charts and to transfer them from your ISOBUS terminal.

- Management of fertilizer charts can be done via the connection of the WiFi module to the ECU.

#### Creating a new fertilizer chart

You can create up to 30 fertilizer charts in the electronic machine control unit.



- ▶ Access the menu Fertiliser settings > Fertiliser charts.

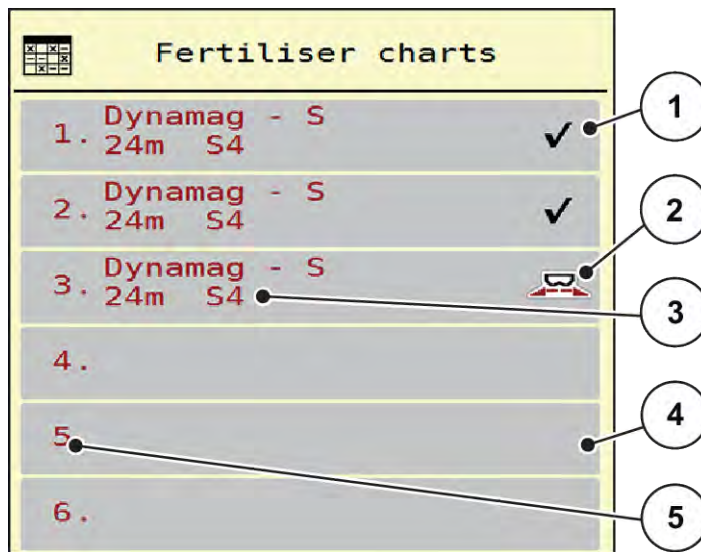

Fig. 17: Menu Fertiliser charts

- [1] Indicates a fertilizer chart filled with values
- [2] Indicates an active fertilizer chart
- [3] Fertilizer chart name field
- [4] Empty fertilizer chart
- [5] Chart number

- ▶ Select an empty fertilizer chart.

The name field consists of the fertilizer name, the working width and the spreading disc type.

*The display shows the selection window.*

- ▶ Press the option Open and back to fertiliser settings.

*The Fertiliser settings menu is displayed and the selected element is loaded into the fertilizer settings as the active fertilizer chart.*

- ▶ Select the Fertiliser name menu item.
- ▶ Enter a name for the fertilizer chart.



We recommend naming the fertilizer chart after the fertilizer. Specific fertilizers can thus be assigned to fertilizer charts more easily.

- ▶ Edit the parameters of the fertilizer chart. See 4.5 Fertilizer settings.

### Selecting a fertilizer chart

- ▶ Access the menu Fertiliser settings > Open and back to fertiliser settings.
- ▶ Select the desired fertilizer chart.  
*The display shows the selection window.*
- ▶ Select the option Open and back to spreading mat. settings.

*The Fertiliser settings menu is displayed and the selected element is loaded into the fertilizer settings as the active fertilizer chart.*



When selecting an existing fertilizer chart, all values in the Fertiliser settings menu will be overwritten with the stored values obtained from the selected fertilizer chart, including the drop point and the normal disc speed.

- The machine control unit will move the drop point to the value stored in the fertilizer chart.

### Copying an existing fertilizer chart

- ▶ Select the desired fertilizer chart.  
*The display shows the selection window.*
- ▶ Select the option Copy element.

*A copy of the fertilizer chart is now in the first free position on the list.*

### Deleting an existing fertilizer chart

- ▶ Select the desired fertilizer chart.  
*The display shows the selection window.*



The active fertilizer chart cannot be deleted.

- ▶ Select the option Delete element.

*The fertilizer chart is deleted from the list.*

### Managing the selected fertilizer chart via the working screen

You can also manage the fertilizer chart directly via the operating screen

- ▶ Press the Fertilizer chart button [2] on the touch screen.  
*The active fertilizer chart is displayed.*

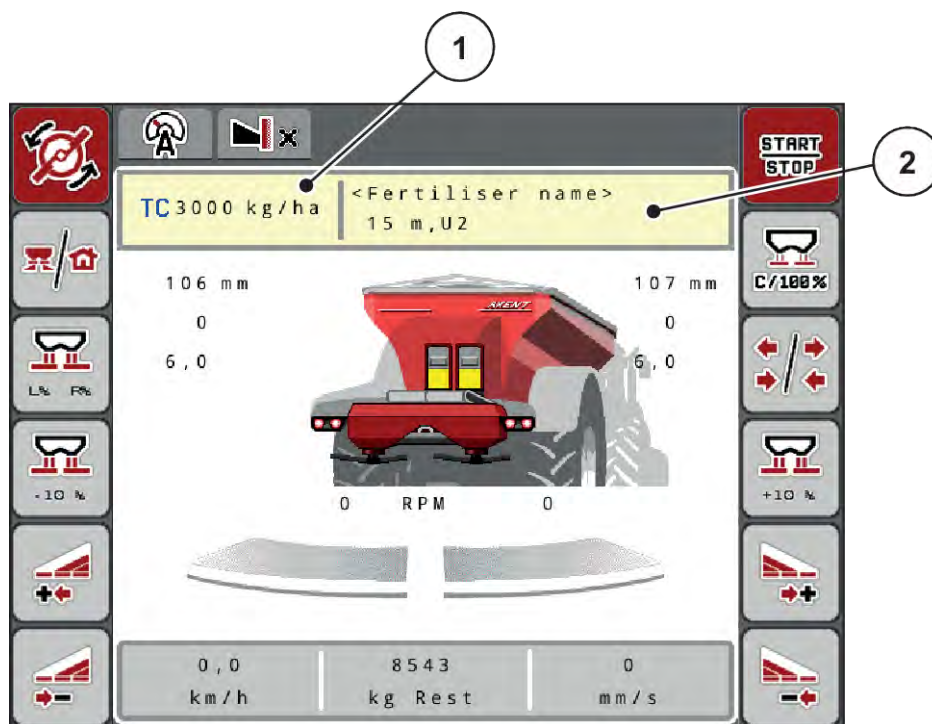

Fig. 18: Managing the fertilizer chart via the touch screen

- [1] Button Application rate
- [2] Button Fertiliser chart

- ▶ Enter the new value in the input field.
- ▶ Press OK.

*The new value is saved in the machine control unit.*

## 4.6 Fertilizer settings (UNIVERSAL PowerPack)



The machine control unit automatically detects the attached spreading unit after connecting the ISOBUS connector to the AXENT large area spreader.

Some menu entries differ depending on whether the AXIS-PowerPack fertilizer spreading unit or the UNIVERSAL-PowerPack lime spreading unit is attached.



In this menu, the fertilizer and spreading settings can be changed.

- ▶ Access the menu Main menu > Fertiliser settings.



Not all parameters are displayed simultaneously on one screen. You can switch to the next or previous menu windows (tabs) using the **left/right arrow** keys.

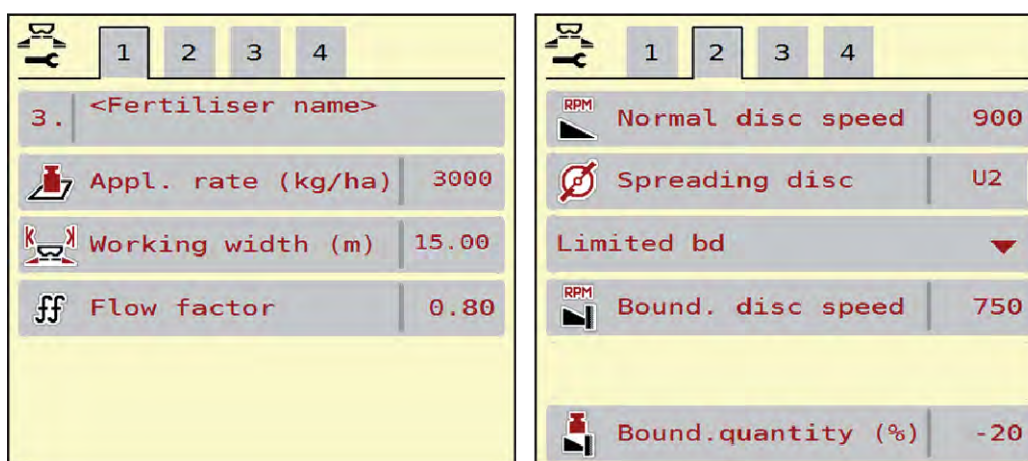

Fig. 19: Menu Fertiliser settings, lime operation, tabs 1 and 2



The menu entries in tabs 3 and 4 are irrelevant to the UNIVERSAL-PowerPack lime spreading unit.

Sub-menu	Meaning	Description
Fertiliser name	Fertilizer selected from the fertilizer chart	4.5.13 Fertilizer charts
Appl. rate (kg/ha)	Input of target value for the application rate in kg/ha	4.6.1 Application rate

Sub-menu	Meaning	Description
Working width (m)	Determination of the working width to be spread	4.6.2 <i>Setting the working width</i>
Flow factor	Input of flow factor of the fertilizer used	4.6.3 <i>Flow factor</i>
Normal disc speed	Input of the desired spreading disc speed Influences the EMC mass flow control	4.6.5 <i>Rotation speed</i>
Spreading disc	Setting the type of spreading disc mounted on the UNIVERSAL-PowerPack Note: Sxx spreading discs are for use only on the AXIS-PowerPack	Selecting a type: <ul style="list-style-type: none"> <li>• U2</li> </ul>
Bound. sprd.type	Selection list: <ul style="list-style-type: none"> <li>• Limited bd</li> <li>• Full bord.</li> </ul>	Selection with arrow keys, confirmation with the Enter key
Bound. disc speed	Pre-setting the RPM in the boundary spreading mode	To be entered in a separate input window
Limit. bd rate (%)	Pre-setting the application rate reduction in boundary spreading mode	To be entered in a separate input window

#### 4.6.1 Application rate



In this menu, you can enter the target value for the desired application rate.

##### Entering the application rate:

- ▶ Access the menu Fertiliser settings > Appl. rate (kg/ha).  
*The currently applied application rate is displayed.*
- ▶ Enter the new value in the input field.
- ▶ Press **OK**.  
*The new value is saved in the machine control unit.*

You can also enter or adjust the application rate directly via the working screen.

- ▶ Press the Appl. rate (kg/ha) [1] button on the touch screen.  
*The number input window is displayed.*

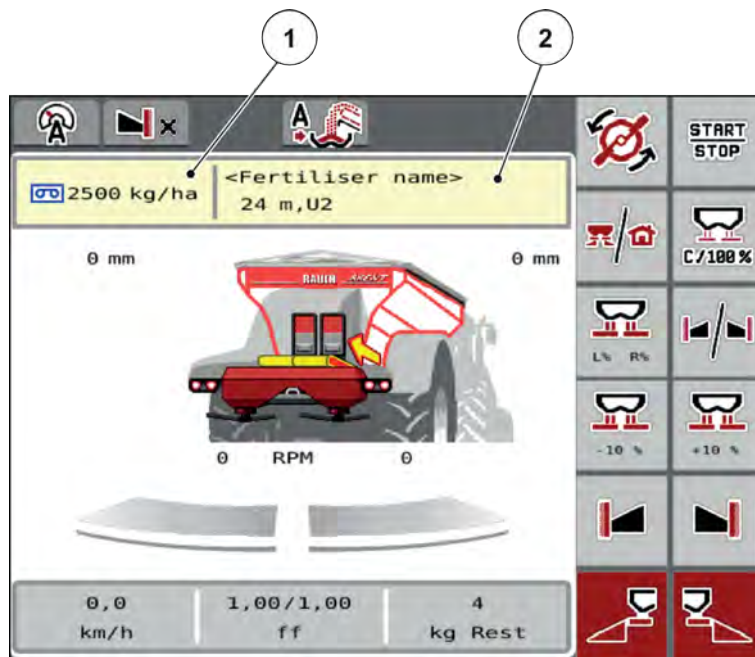

Fig. 20: Entering the application rate on the touch screen

- [1] Button Application rate
- [2] Button Fertiliser chart

- ▶ Enter the new value in the input field.
- ▶ Press **OK**.

*The new value is saved in the machine control unit.*

### 4.6.2 Setting the working width



You can set the working width (in meters) in this menu.

- ▶ Access the menu Fertiliser settings > Working width (m).  
*The **currently applied** working width is displayed.*
- ▶ Enter the new value in the input field.
- ▶ Press **OK**.

*The new value is saved in the machine control unit.*



The working width cannot be adjusted whilst spreading is in progress.

### 4.6.3 Flow factor



The flow factor lies within the range of **0.2** to **1.9**. With identical basic settings (km/h, working width, kg/ha), the following applies:

- If the flow factor is **increased**, the dosing quantity is **reduced**
- If the flow factor is **reduced**, the dosing quantity is **increased**

An error message is displayed if the flow factor is outside the preset range. See chapter 7.1 *Meaning of the alarm messages*.

#### Entering the flow factor:

- ▶ Access the menu Fertiliser settings > Flow factor.  
*The currently set flow factor is displayed.*
- ▶ Enter the value obtained from the fertilizer chart into the input field.

#### Application rates at 10 km/h and 30 cm pre-metering slide opening

Lime type	Density (kg/m <sup>3</sup> )	Grinding stage	Flow factor	Dry substance (%)	Working width (m)	Application rate max. (kg/ha)
Burnt lime, ground	1100	1	0.88	100	10	9700
Burnt lime, granulated	1100	-	0.88	100	18	5380
Converter lime	1300	2	1.04	90	15	7640
Carbonated lime	1000	-	0.80	72	12	7340
Mixed lime	1100	2	0.88	88	12	8080
Calcium carbonate	1200	2	0.96	92	12	8810
Magnesium lime	1100	1	0.88	94	10	10580
Black lime	900	1	0.72	83	12	6610

For lime types which do not appear in the list, it is possible to calculate the flow factor with the formel below

- Flow factor (FF) = Density (kg/liter) x 0.8

#### Minimum factor

The machine control unit automatically sets the minimum factor to one of the following values, depending on the entered value:

- The minimum factor is 0.2 if the entered value is less than 0.5
- The minimum factor is 0.4 if you enter a value over 0.5.

#### ■ Flow factor with UNIVERSAL EMC

The flow factor on the UNIVERSAL-PowerPack with UNIVERSAL EMC is determined by the EMC mass flow controller.

#### Selecting the AUTO km/h + AUTO kg operating mode

- ▶ Access the menu Machine settings > AUTO/MAN mode.
- ▶ Select the menu entry AUTO km/h + AUTO kg.
- ▶ Press OK.



We recommend that the flow factor is displayed on the working screen. By doing so, you can observe the mass flow control during spreading. See 2.1.2 *Display fields*.

An idle measurement must be performed for the EMC calculation. The idle measurement is always started when the spreading discs are started. During the idle measurement, the window shown alongside appears.

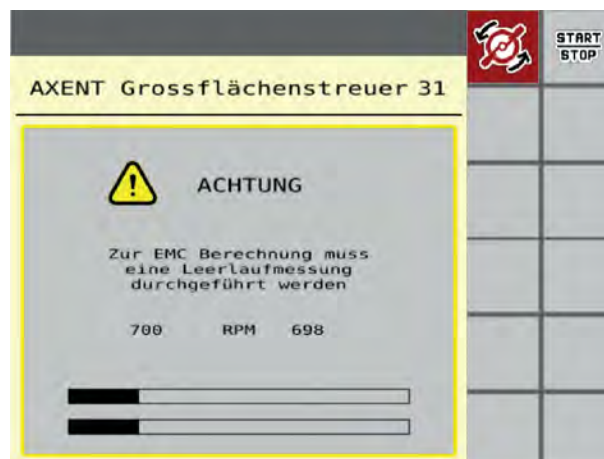

#### 4.6.4 Disc type

The mounted spreading disc type has a default factory setting. If you have mounted different spreading discs on your machine, you must enter the correct type.



- ▶ Access the menu Fertiliser settings > Spreading disc.
- ▶ Activate spreading disc type **U2**.

*The Fertiliser settings window is displayed with the new spreading disc type.*

## 4.6.5 Rotation speed

### ■ Normal disc speed

The factory default speed is set to 700 rpm. If you want to set a different speed, you must change the saved value. The speed setting can be raised to a maximum value of 800 rpm.

- ▶ Access the menu Fertiliser settings > Normal disc speed.
- ▶ Enter the speed value.

*The Fertiliser settings window is displayed with the new speed.*

## 4.7 Machine settings



In this menu, you can enter settings for the tractor and the machine.

- ▶ Access the menu Machine settings.

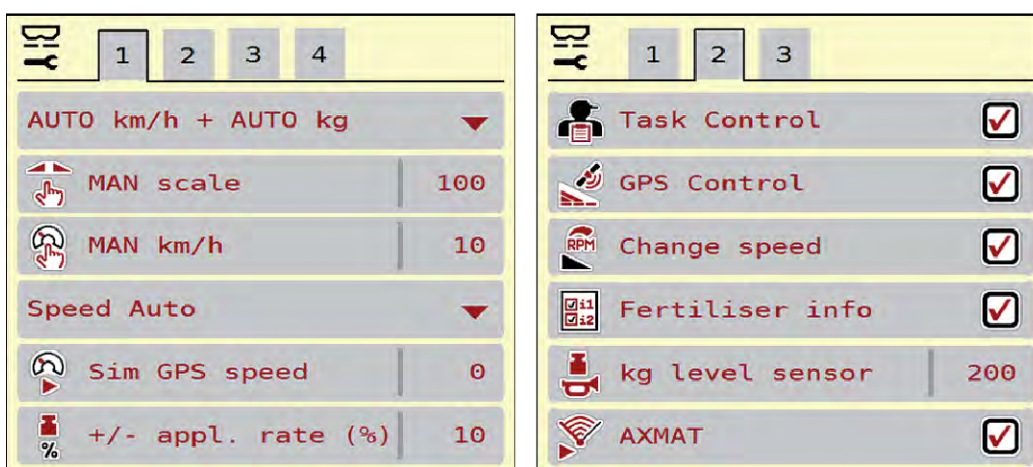

Fig. 21: Machine settings menu, tab 1 and 2

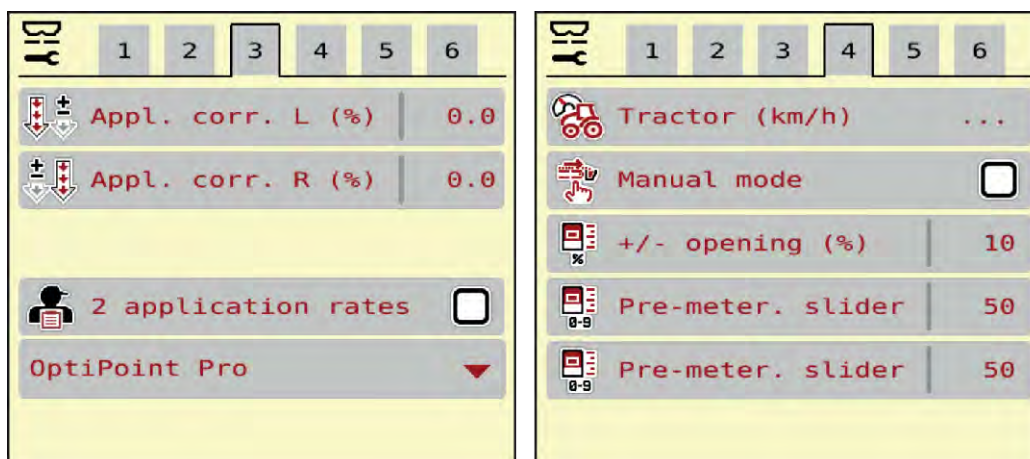

Fig. 22: Machine settings menu, tab 3 and 4



Not all parameters are displayed simultaneously on one screen. You can switch to the next or previous menu windows (tabs) using the left/right arrow keys.

Sub-menu	Meaning	Description
AUTO/MAN mode	Specifying automatic or manual operating mode	4.7.1 AUTO/MAN mode
MAN scale	Setting the manual scale value. (only influences the respective operating mode)	To be entered in a separate input window.
MAN km/h	Setting the manual speed. (only influences the respective operating mode)	To be entered in a separate input window.
Speed/signal source	Selection/limitation of the speed signal <ul style="list-style-type: none"> <li>Speed AUTO (automated selection of either transmission or radar/GPS)<sup>1</sup></li> <li>GPS J1939<sup>1</sup></li> <li>NMEA 2000</li> </ul>	
Sim GPS speed	For GPS J1939 only: Indication of forward speed in the event of loss of the GPS signal	<b>NOTE!</b> The entered forward speed is to be maintained constantly at all times.

<sup>1)</sup> The manufacturer does not assume any liability in the event of a loss of the GPS signal.

Sub-menu	Meaning	Description
+/- appl. rate (%)	Pre-setting the application rate change for the different spreading types	To be entered in a separate input window
Task Control	Activation of the ISOBUS Task Controller functions for documentation and for application map spreading <ul style="list-style-type: none"> <li>• Task Control on (checked)</li> <li>• Task Control off</li> </ul>	
GPS-Control	Activation of the function to control the machine sections via GPS control unit <ul style="list-style-type: none"> <li>• Task Control on (checked)</li> <li>• Task Control off</li> </ul>	
Rpm modification	Activation of the function for modifying the RPM in the boundary spreading mode in the working screen. If this function is deactivated, the change can only be made as a percentage value (%).	<b>No function in lime operation</b>
Fertilizer info	Activation of the fertilizer information (fertilizer name, spreading disc type, working width) in the working screen.	
kg level sensor	Input of the remaining quantity to trigger an alarm message via the weigh cells	
AXMAT	<b>AXIS-H 50 only</b> Activate the AXMAT function	Please observe the operator's manual for the special equipment.
Appl. corr. L (%) Appl. corr. R (%)	Correction of the deviations between the entered application rate and the actual application rate <ul style="list-style-type: none"> <li>• Correction in percent on the right and/or left side</li> </ul>	
Tractor (km/h)	Determining or calibrating the speed signal	<i>4.7.9 Forward speed calibration</i>

Sub-menu	Meaning	Description
Manual mode		4.7.8 Opening adjustment <b>No function in lime operation</b>
Pre-metering (mm)		To be entered in a separate input window. <b>No function in lime operation</b>
+/- opening (%)	Pre-setting of the opening adjustment for pre-metering slide	To be entered in a separate input window. <b>No function in lime operation</b>
Belt speed (mm/s)	Setting the conveyor belt speed	4.7.5 Belt speed <b>No function in lime operation</b>
+/- belt sp (mm/s)	Pre-setting of the speed adjustment for the conveyor belt	To be entered in a separate input window <b>No function in lime operation</b>
2 application rates	Only when working with application maps: Activation of two separate application rates for the right and left side, respectively	
OptiPoint version	Select the OptiPoint calculation to be used	

#### 4.7.1 AUTO/MAN mode

The machine control unit automatically adjusts the dosing quantity according to the speed signal. This adjustment is influenced by the application rate, working width, and flow factor.

By default, the unit is operated in the **automatic** mode.

You only work in **manual** mode in the following cases:

- If there is no speed signal (radar or wheel sensor not available or defective)
- Application of slug pellets or seeds (fine seeds)



For uniform spreading of the spreading material, a **constant forward speed** must be applied in manual operating mode.



Spreading in different operating modes is described in *5 Spreading operation with AXIS-PowerPack*.

Menu	Meaning	Description
AUTO km/h + AUTO kg	Selecting automatic mode with automatic weighing	Page 94
AUTO km/h	Selecting automatic mode	Page 97
MAN km/h	Adjustment of forward speed for manual mode	Page 98
MAN scale	Dosing slide adjustment for manual mode This operating mode is suitable for spreading slug pellets or fine seeds.	Page 99

### Operating mode selection

- ▶ Start the machine control unit.
- ▶ Access the menu Machine settings > AUTO/MAN mode.
- ▶ Select the desired menu item from the list.
- ▶ Press OK.
- ▶ Follow the instructions on the screen.



We recommend having the flow factor displayed in the working screen. By doing so, you can observe the mass flow control during spreading. See 2.1.2 *Display fields*.

- Important information on the use of operating modes for spreading operations is provided in chapter 5 *Spreading operation with AXIS-PowerPack*.

### 4.7.2 +/- quantity



In this menu, you can set the percentage increment of the **application rate change** for normal spreading.

The base value (100%) is the preset value for the metering slider opening.



During operation, the Quantity +/-Quantity - function keys can be used to adjust the application rate by the +/- Quantity factor at any time. The pre-configuration can be reset with the C 100 % key.

**Specifying the application rate reduction:**

- ▶ Access the menu Machine settings > +/- appl. rate (%).
- ▶ Enter the percentage by which the application rate is to be adjusted.
- ▶ Press OK.

**4.7.3 Overloading function operating mode**

The overloading function with the different operating modes is described in chapters 5.1 *Overloading* and 6.1 *Overloading*.

- Observe the operator's manual of your AXENT large area spreader.

They control overloading of fertilizer in the AXIS-PowerPack or UNIVERSAL-PowerPack spreading units via 2 optional operating modes.



Fig. 23: Symbolic operating mode

[1] Automatic mode

[2] Manual

It is recommended to always work in automatic operating mode Automatic mode. The machine control system fully automatically controls the valves for fertilizer supply according to sensor information.



Start in Manual operating mode and stop overloading by pressing the Activation key. The sensor conditions signal the required steps.

**Selecting the operating mode**

- ▶ Switch on the machine control unit.
- ▶ Access the menu Machine settings > AUTO/MAN mode.
- ▶ Select the desired menu item from the list.
- ▶ Press OK.

- **Automatic**

**! WARNING!**

**Danger of crushing and shearing due to externally-actuated components**

The pre-metering slide and the conveyor belt move without warning and may lead to personal injury.

- ▶ Ensure that nobody is present in the hazard zone.

See also 5.1.1 *Overloading in automatic operating mode* and 6.1 *Overloading*.

#### ■ **Manual (AXIS-PowerPack only)**

### ⚠ CAUTION!

#### **Risk of slipping and environmental damage due to ejected fertiliser**

If overloading is active, overflow in the fertiliser spreader may occur and excessive fertiliser may leak unexpectedly from the hopper.

Persons may slip and be injured.

Risk for the environment.

- ▶ Make sure nobody is present in the spreading zone of the machine before switching on the spreading discs.
- ▶ Activate the **Manual** mode briefly in exceptions.
- ▶ Use the **Automatic** mode if possible.

- ▶ Access the menu Machine settings.

- ▶ Select the Manual mode menu item.

*Warning message no. 39 is displayed. See 7.1 Meaning of the alarm messages.*

- ▶ Press ACK.

*The warning message is acknowledged.*

*The box is checked: The operating mode is active.*

- ▶ Press the Start overloading key.

*Overloading is started.*



Overloading is implemented in the same sequence as for the Automatic mode operating mode.

- ▶ Press the Start overloading key.

*Overloading is stopped.*



- See also 5.1.2 *Overloading in manual operating mode*.

## 4.7.4 Settings for lime operation

When starting the machine control unit, the attached lime spreading unit is automatically detected and the machine control unit switches to lime operation.

Lime operation is speed-dependent: The speed of the conveyor belt and opening of the pre-metering slide are automatically adjusted to the forward speed to ensure even lime spreading.

- ▶ Access the menu Machine settings > AUTO/MAN mode.
- ▶ Select the AUTO km/h or MAN km/h menu item.

You can start lime operation.

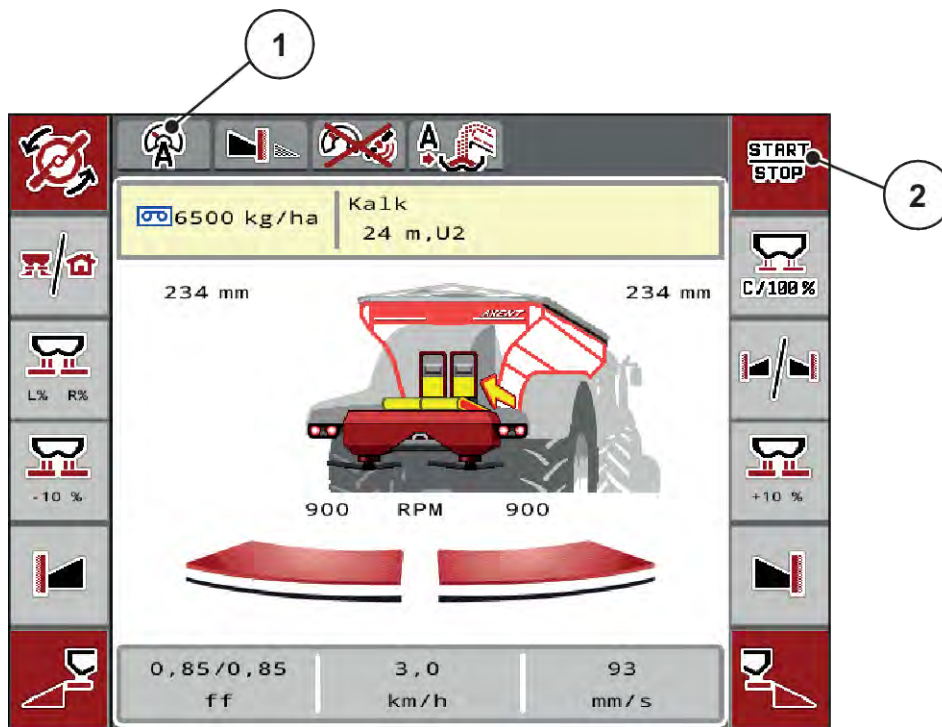

Fig. 24: Operating screen in lime operation

- [1] Symbol of active lime operating mode    [2] Starting the spreading operation  
AUTO km/h

#### 4.7.5 Belt speed

##### ■ Only with AXIS-PowerPack AXIS-PowerPack

In this menu, the speed of the conveyor belt can be defined.

During operation, the speed of the conveyor belt can be adjusted in the operating screen. See 4.7.6 +/- belt speed.



- ▶ Access the menu Machine settings > Belt speed (mm/s).
- ▶ Enter the value of the speed adjustment.
- ▶ Press OK.

#### 4.7.6 +/- belt speed

##### ■ Only with AXIS-PowerPack AXIS-PowerPack

In this menu, you can preset the **speed adjustment**.



The preset value of the dosing slider opening serves as basis (100 %).





**Only available in manual mode:** During operation, the conveyor belt speed can be adjusted by the preset value (mm/s) at any time by pressing the Speed +/-Speed - function keys.

The pre-configuration can be reset with the C 100 % key.

- ▶ Access the menu Machine settings > +/- belt sp (mm/s).
- ▶ Enter the value of the speed adjustment.
- ▶ Press OK.

#### 4.7.7 Opening the pre-metering slides

##### ■ *Only with AXIS-PowerPack AXIS-PowerPack*

In this menu, the pre-metering slide opening can be defined.

During operation, the pre-metering slide opening can be adjusted in the operating screen.



- ▶ Access the menu Machine settings > Pre-metering (mm).
- ▶ Enter the value from the fertiliser chart.
- ▶ Press OK.

#### 4.7.8 Opening adjustment

##### ■ *Only with AXIS-PowerPack AXIS-PowerPack*

In this menu, a percentage adjustment of the pre-metering slide opening can be defined.

The preset value of the pre-metering slide opening serves as basis (100 %).

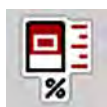

**Only available in manual mode:** During operation, pre-metering slide opening by the preset value (mm/s) at any time by pressing the Opening +/-Opening - function keys.

The pre-configuration can be reset with the C 100 % key.

- ▶ Access the menu Machine settings > +/- opening (%).
- ▶ Enter the value of the speed adjustment.
- ▶ Press OK.

#### 4.7.9 Forward speed calibration

The speed calibration is the basic requirement for a precise spreading result. Factors such as tire size, a different tractor, all-wheel drive, slippage between tires and ground, ground characteristics, and tire pressure influence the speed measurement and therefore the spreading result.

Exact calculation of the number of speed pulses over 100 m is very important for the precise discharge of the fertilizer quantity.

### Preparing the speed calibration

- ▶ Conduct the calibration on the field. This reduces the influence of the ground characteristics on the calibration result.
- ▶ Determine a 100 m long reference track as precisely as possible.
- ▶ Switch on all-wheel drive.
- ▶ Fill only half of the machine, if possible.

### ■ Accessing the speed settings

You can save up to 4 different profiles for the type and number of pulses and assign names to these pulses (e.g., tractor name).

Before spreading, check that the correct profile is opened in the control unit.

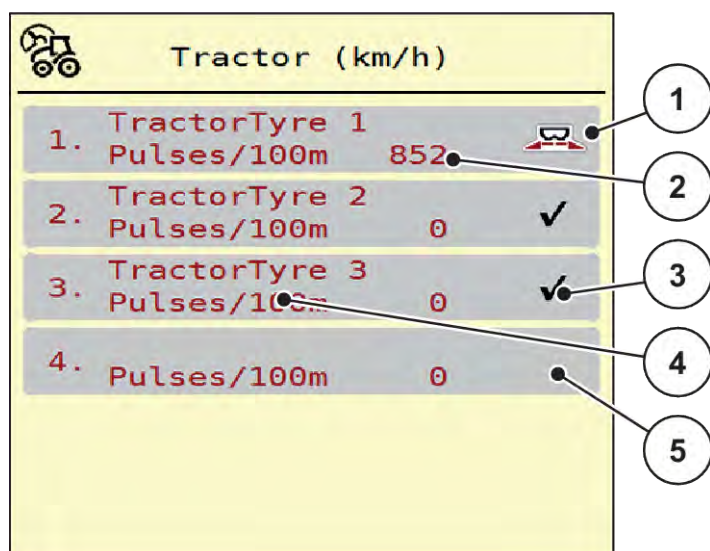

Fig. 25: Menu Tractor (km/h)

- |  |                           |
|--|---------------------------|
| [1] Active tractor profile                     | [4] Tractor type          |
| [2] Display of the number of pulses over 100 m | [5] Empty tractor profile |
| [3] Profile is created, currently not used     |                           |

- ▶ Access the menu Machine settings > Tractor (km/h).

### ■ Recalibrating the speed signal

You can either overwrite an existing profile or create a profile in an empty memory location.

- ▶ In the Tractor (km/h) menu, select the desired profile.
- ▶ Press the **Enter key**.

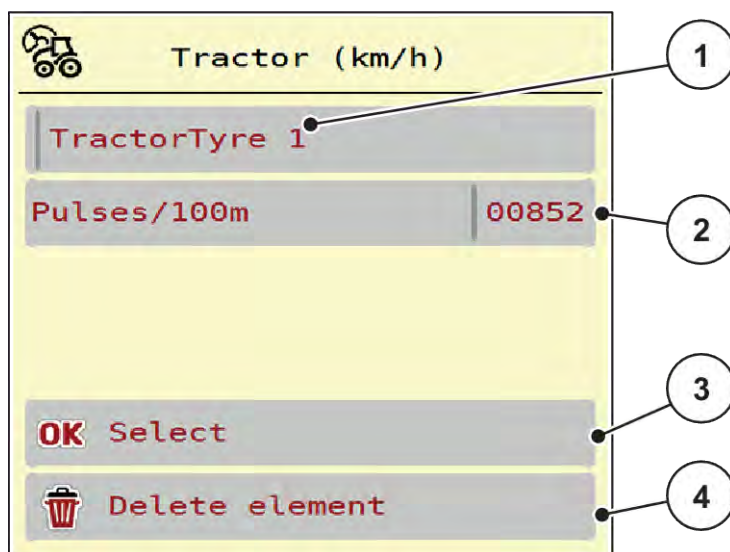

Fig. 26: Tractor profile

- |  |                                   |
|--|-----------------------------------|
| [1] Tractor name field                         | [3] Confirm the profile selection |
| [2] Display of the number of pulses over 100 m | [4] Delete profile                |

- ▶ Open **Name field [1]**.
- ▶ Enter the name of the profile.

*The profile is active.*



The name is restricted to 16 characters.

We recommend using the name of the tractor for ease of understanding.

The number of pulses of the speed signal must still be specified below. If the exact pulse count is known, it can be entered directly:

- ▶ From the selected tractor profile, select the Pulses/100m menu entry.

*The Pulses menu is displayed for manual entry of the pulse count.*

If the exact pulse count is **unknown**, start a **calibration**.

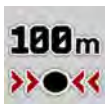

- ▶ Press the calibration key in the tractor profile.  
*The calibration run operating screen is displayed.*



- ▶ Press Start at the starting position of the reference distance.  
*The pulse display is now zero.*

*The machine control unit is ready for counting pulses.*

- ▶ Drive along the 100 m long reference distance.
- ▶ Stop the tractor at the end of the reference distance.



- ▶ Press Stop.

*The display shows the number of received pulses.*

*The new pulse count is saved.*

*The profile menu is displayed again.*

## 4.8 Fast emptying



In order to quickly clean the machine after spreading or to quickly empty any residual material, you can select the Fast emptying menu.

For this purpose, before storing the machine, we recommend **completely opening** the metering sliders with the fast emptying function and switching off the control unit in this state. This prevents the accumulation of humidity in the hopper.



**Before starting** the fast emptying process, care must be taken to ensure that all requirements have been met. Observe the operator's manual for the mineral fertilizer spreader (discharging residual material).

**Carrying out the fast emptying process:**

- ▶ Access the menu Main menu > Fast emptying.

**⚠ CAUTION!**

**Risk of injury due to automatic adjustment of the drop point**

The Approach drop point Yes = Start alarm will appear for **EMC machines**. When you press the Start/Stop function key, the drop point automatically moves to position 0. After the calibration, the drop point automatically moves to the preset value again. This may cause injury and property damages.

- ▶ Before pressing the Start/Stop key, ensure that **nobody** is present in the hazard zone of the machine.

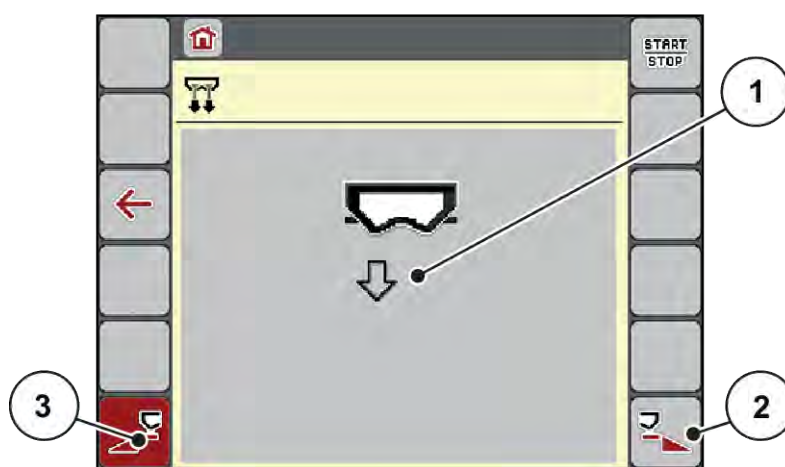

Fig. 27: Menu Fast emptying

- |  |  |
|--|--|
| [1] Icon for fast emptying (here: left side not selected, not started) | [3] Fast emptying of the left section (not selected) |
| [2] Fast emptying of the right section (selected)                      |  |

- ▶ Press the **function key** to select the section for which the fast emptying function is to be carried out.

*The selected section is displayed as an icon (Fig. 27 position [3]).*

- ▶ Press **Start/Stop**.

*The fast emptying process starts.*

- ▶ Press **Start/Stop** when the hopper is empty.

*Fast emptying is complete.*

- ▶ ESC to return to the Main menu.

**⚠ CAUTION!****Risk of injury due to automatic adjustment of the drop point**

The Approach drop point Yes = Start alarm will appear for **EMC machines**. When you press the Start/Stop function key, the drop point automatically moves to position 0. After the calibration, the drop point automatically moves to the preset value again. This may cause injury and property damages.

- ▶ Before pressing the Start/Stop key, ensure that **nobody** is present in the hazard zone of the machine.

## 4.9 System/Test

SYS  
TEST

In this menu, the system and test settings for the machine control unit can be configured.

- ▶ Access the menu Main menu > System / Test.

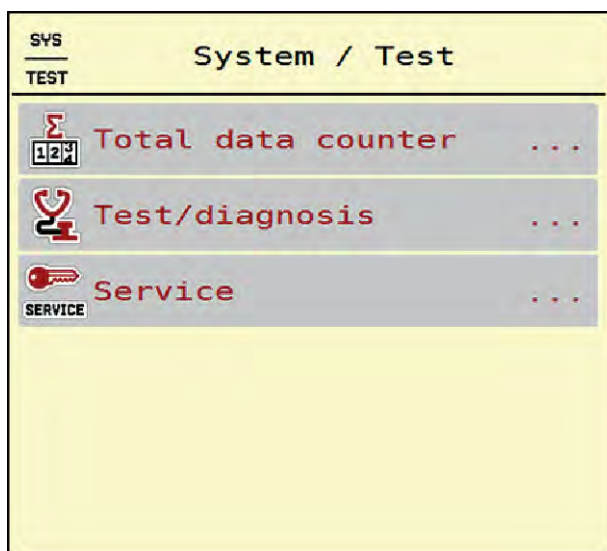

Fig. 28: Menu System / Test

Sub-menu	Meaning	Description
Total data counter	Display list <ul style="list-style-type: none"> <li>• spread quantity in kg</li> <li>• spread area in ha</li> <li>• spread time in h</li> <li>• distance traveled in km</li> </ul>	4.9.1 Total data counter
Test/diagnosis	Checking of actuators and sensors	4.9.2 Test/diagnosis

Sub-menu	Meaning	Description
Service	Service settings	Password-protected; only accessible for service personnel

#### 4.9.1 Total data counter



In this menu, all of the spreader's counter readings are displayed.

- spread quantity in kg
- spread area in ha
- spread time in h
- distance traveled in km



This menu is for information purposes only.

 <b>Total data counter</b>	
kg calculated	712168
ha	1902.4
hours	93
km	673

Fig. 29: Menu Total data counter

#### 4.9.2 Test/diagnosis



In the Test/diagnosis menu, you can check the functions of all actuators and sensors.



This menu is for information purposes only.

The list of sensors depends on the equipment of the machine.

**⚠ CAUTION!****Risk of injury due to moving machine parts**

During the tests, machine parts may move automatically.

- ▶ Before carrying out the tests, ensure that nobody is present in the danger zone of the machine.

Sub-menu	Meaning	Description
Voltage	Checking the operating voltage	
Metering slider	Moving the left and right metering slides	<i>Example: metering slides</i>
Test points slider	Test for approaching the various position points of the metering slides	Calibration check
Drop point	Manual movement of the drop point motor	
Test points drop pt.	Approaching the drop point	Calibration check
LIN bus	Checking the assemblies registered via LIN bus	<i>Example: LIN bus</i>
Spreading disc	Manual activation of the spreading disc	
Agitator	Checking the agitator	
EMC sensors	Checking the EMC sensors	
Weigh cell	Checking the sensors	
Level sensor	Checking the level sensors	
AXMAT sensor status	Checking the sensor system	
Oil tank	Checking the oil temperature and the oil level	
Pre-metering	Test function for opening/closing the pre-metering slides	Calibration check
Belt drive	Manual operation of the conveyor belt	
Hopper cover	Checking the actuators	
Sensor cover	Checking of the safety switch at the safety hood	<i>Sensor cover example</i>
SpreadLight	Checking the operating lights	
Lime functions	Control of the comb roller and the vibrator	<i>Example Lime functions</i>

■ **Sensor cover example**



- ▶ Access the menu System / Test > Test/diagnosis.
- ▶ Press the left/right arrows to navigate to the Sensor cover menu entry.

The display shows the status of the actuators/sensors.

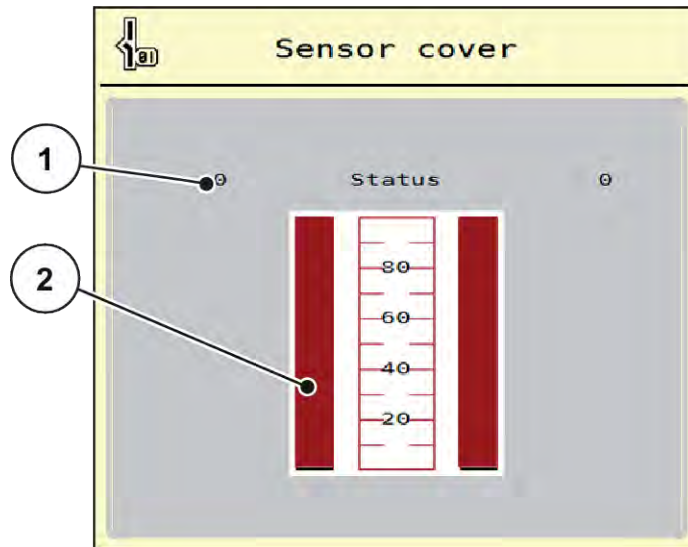

Fig. 30: Test/diagnosis; Example: Sensor cover

- [1] Signal display; 1: Safety hood is closed; 0: Safety hood is open
- [2] Signal bar graph

#### ■ Example Lime functions

- ▶ Access the menu System / Test > Test/diagnosis.
- ▶ Press the left/right arrows to navigate to the Lime functions menu entry.

The display shows the status of optional equipment.

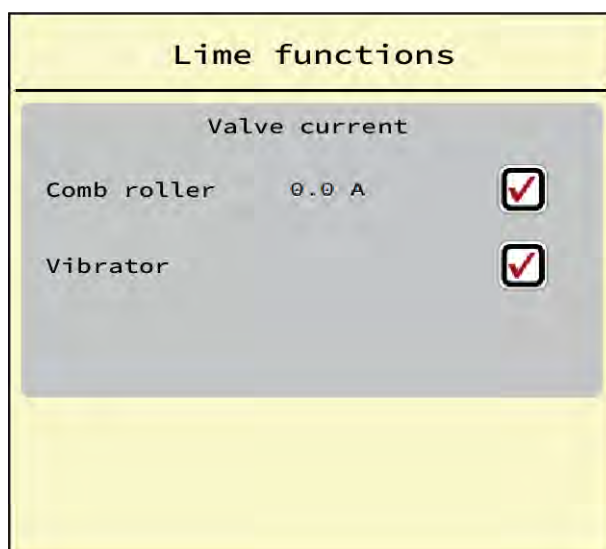

Fig. 31: Test/diagnosis; Example: Lime functions

- ▶ Check the function on the touch screen.



- ▶ Press Start/Stop.

*The test for control of the selected equipment is started.*

- ▶ Press Start/Stop again.

*The test is completed.*

#### ■ **Example: metering slides**

- ▶ Access the menu Test/diagnosis > Metering slider.

*The status of the motors/sensors is displayed.*

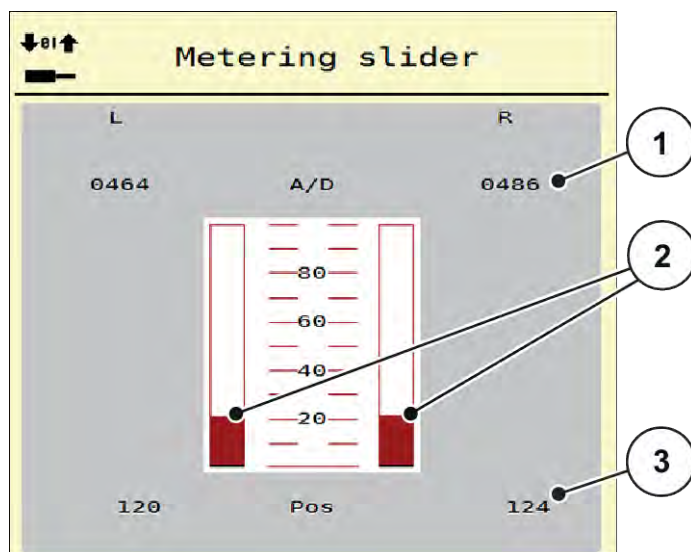

Fig. 32: Test/diagnosis; Example: Metering slider

- [1] Signal display
- [2] Signal bar graph

- [3] Position display

The Signal display shows the status of the electrical signals for the left and right side separately.

### ⚠ CAUTION!

#### **Risk of injury due to moving machine parts**

During the tests, machine parts may move automatically.

- ▶ Before carrying out the tests, ensure that nobody is present in the danger zone of the machine.

You can open and close the metering sliders with the up/down arrows.

#### ■ **Example: LIN bus**

- ▶ Access the menu System / Test > Test/diagnosis.
- ▶ Select the LIN bus menu item.

The display shows the status of the actuators/sensors.

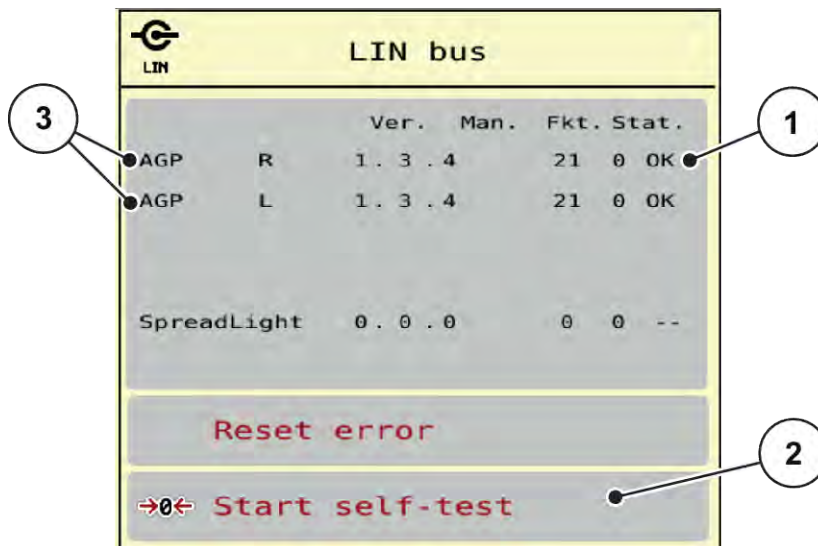

Fig. 33: System / Test; Example: Test/diagnosis

- [1] Status display
- [2] Start self-test

[3] Connected equipment

### Linbus participant status notification

The devices indicate various conditions:

- 0 = OK; no equipment error
- 2 = blockage
- 4 = overload

### ⚠ CAUTION!

#### Risk of injury due to moving machine parts

During the tests, machine parts may move automatically.

- ▶ Before carrying out the tests, ensure that nobody is present in the danger zone of the machine.



When the system is restarted, the status is checked and typically reset. Since the status is not always reset automatically in certain cases, it is now also possible to perform a manual RESET.

- Press the Reset error button.

### 4.9.3 Service



An input code is required to configure the settings in the Service menu. These settings can only be modified by authorized service personnel.

### 4.10 Info



The Info menu provides information on the machine control unit.



This menu provides information on the configuration of the machine.

The information list depends on the equipment of the machine.

### 4.11 Weighing/Trip counter



This menu provides values regarding spreading work carried out and functions for the weighing operation.

► Access the menu Main menu > Weighing/Trip count..

*The Weighing/Trip count. menu appears.*

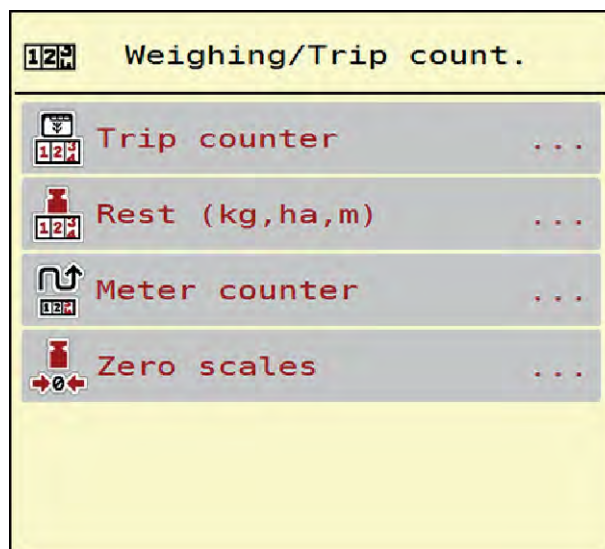

*Fig. 34: Menu Weighing/Trip count.*

Sub-menu	Meaning	Description
Trip counter	Display of the fertilizer quantity spread, area spread, and spread distance	4.11.1 Trip counter
Rest (kg, ha, m)	For weighing spreaders only: Display of the remaining quantity in the hopper	4.11.2 Rest (kg, ha, m)
Meter counter	Display of the distance traveled since the last reset of the meter counter	Reset (zeroing) by pressing the <b>C 100%</b> key
Zero scales	For weighing spreaders only: Weighing value for empty scales is set to "0 kg"	4.11.3 Zero scales

### 4.11.1 Trip counter



In this menu, the values of the spreading work carried out can be obtained, the remaining spreading quantity can be observed, and the trip counter can be reset by deleting.

- Access the menu Weighing/ Trip count > Trip counter.

*The Trip counter menu appears.*

During spreading, i. e. with the metering slides being open, you can switch to the Trip counter menu and obtain the current values there.



If you wish to continuously observe the values during spreading, you may also assign the freely selectable display fields in the working screen kg trip, ha trip or m trip, see 2.1.2 *Display fields*.

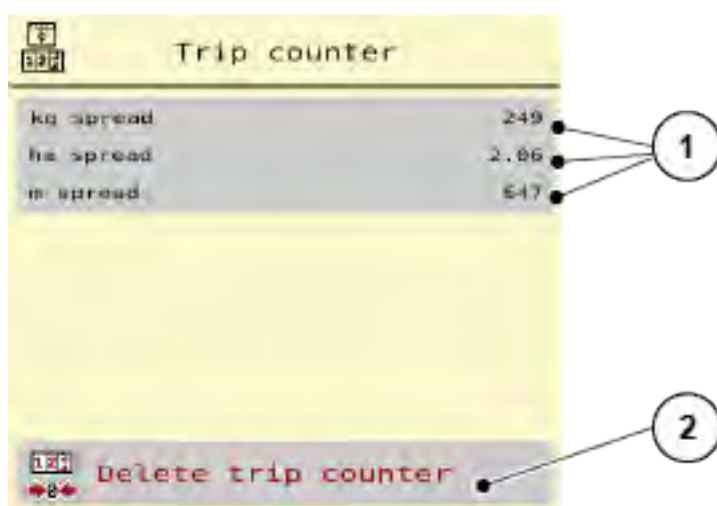

Fig. 35: Menu Trip counter

- [1] Spread quantity, area and distance display fields    [2] Delete trip counter fields

### Clear trip counter

- ▶ Access the sub-menu Weighing/Trip count. > Trip counter.

*The values for spread quantity, area, and distance calculated since the last deletion are displayed.*

- ▶ Press the Delete trip counter button.

*All values of the trip counter are reset to 0.*

### 4.11.2 Rest (kg, ha, m)



In the Rest (kg, ha, m) menu, you can obtain the remaining quantity in the hopper. The menu indicates the possible area (ha) and distance (m) which can still be spread with the remaining fertilizer quantity.

- ▶ Access the menu Weighing/Trip count. > Rest (kg, ha, m).

*The Rest (kg, ha, m) menu appears.*



The current fill weight **in the weighing spreader can only be determined by weighing**. In all other spreaders, the remaining fertilizer quantity is calculated from the fertilizer and machine settings as well as from the drive signal, and the filling quantity must be entered manually (see below). The Application rate and Working width values cannot be changed in this menu. They are for information purposes only.

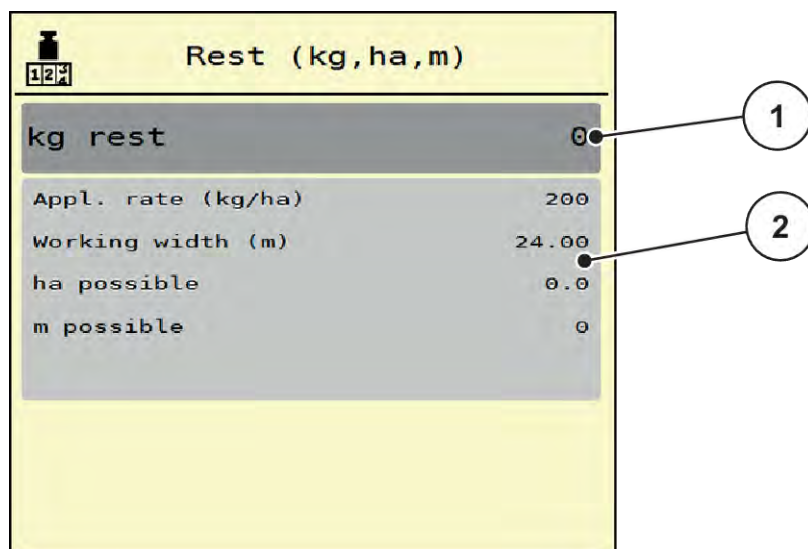

Fig. 36: Menu Rest (kg, ha, m)

[1] Input window kg rest

[2] Application rate, Working width, possible spread area and distance display fields

### 4.11.3 Zero scales

- **For weighing spreaders only**



In this menu, set the weighing value for the empty hopper to 0 kg.

For taring the scales, the following requirements have to be fulfilled:

- the hopper is empty,
- the machine is at a standstill,
- the PTO is switched off,
- the machine is in a horizontal position and off the ground,
- the tractor is at a standstill.

#### Zero scales:

- ▶ Access the menu Weighing/Trip count. > Zero scales.
- ▶ Press the Zero scales button.

*The weighing value for the empty scales is now set to 0 kg.*



Tare the scales before each use in order to ensure problem-free calculation of the remaining quantity.

## 4.12 Operating lights (SpreadLight)



In this menu, you can activate the SpreadLight function, to monitor the spreading pattern even in night mode.

You can switch the operating lights on and off in the automatic and/or manual mode via the machine control unit.

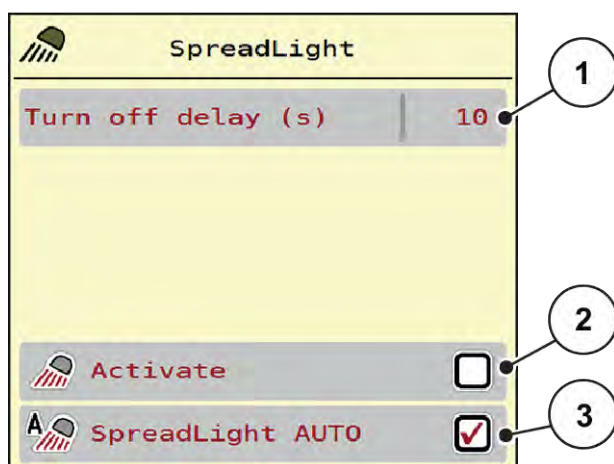

Fig. 37: Menu SpreadLight

[1] Turn off delay (s)

[3] Activate automatic mode

[2] Manual mode: Switch on operating lights



#### Automatic mode:

In the automatic mode, the operating lights are switched on as soon as the metering slides open and the spreading process starts.

- ▶ Access the menu Main menu > SpreadLight.

- ▶ Put a check mark in the menu item SpreadLight AUTO [3].

*The operating lights are switched on when the metering slides open.*

- ▶ Enter a turn off duration [1] in seconds.

*The operating lights will switch off at the end of the entered time, if the metering slides are closed.*

*Range from 0 to 100 seconds.*

- ▶ Remove the check mark in the menu item SpreadLight AUTO [3].

*The automatic mode is deactivated.*



#### Manual mode:

In the manual mode, the operating lights can be switched on and off.

- ▶ Access the menu Main menu > SpreadLight.

- ▶ Put a check mark in the menu item Activate [2].

*The operating lights are activated and remain on until you remove the check mark or leave the menu.*

## 4.13 Special functions

### 4.13.1 Changing the system of units

Your system of units has been preset at the factory. However, the system can be changed from metric to English units at any time.



Due to the great variety of different ISOBUS-compatible terminals, this chapter is limited to the functions of the electronic machine control system without indicating a specific ISOBUS terminal.

- Please observe the instructions for the operation of your ISOBUS terminal in the corresponding operator's manual.



- ▶ Open the Settings menu for the terminal system.

- ▶ Access the menu Unit.

- ▶ Select the desired unit system from the list.

- ▶ Press OK.

*All values of the various menus are converted.*

Menu/value	Conversion of metric to imperial units
kg left	1 x 2.2046 lb.-mass (lbs left)



Menu/value	Conversion of metric to imperial units
ha left	1 x 2.4710 ac (ac left)
Working width (m)	1 x 3.2808 ft
Rate (kg/ha)	1 x 0.8922 lbs/ac
Mounting height cm	1 x 0.3937 in

Menu/value	Conversion of metric to imperial units
lbs left	1 x 0.4536 kg
ac left	1 x 0.4047 ha
Working width (ft)	1 x 0.3048 m
Appl. rate (lb/ac)	1 x 1.2208 kg/ha
Mounting height in	1 x 2.54 cm

### 4.13.2 Using the joystick

As an alternative to the settings in the working screen of the ISOBUS terminal, you may also use a joystick.



If you wish to use a different joystick, please contact your dealer.

- Please observe the instructions in the operator's manual of the ISOBUS terminal.

**■ CCI A3 joystick**

Fig. 38: CCI A3 Joystick, front and rear

- |                         |                                |
|-------------------------|--------------------------------|
| [1] Light sensor        | [3] Plastic grid (replaceable) |
| [2] Display/touch panel | [4] Shift key                  |

**■ CCI A3 Joysticks operating levels**

You can switch between three operating levels with the shift key. The level that is currently active is displayed by the positioning of a light strip at the bottom edge of the display.

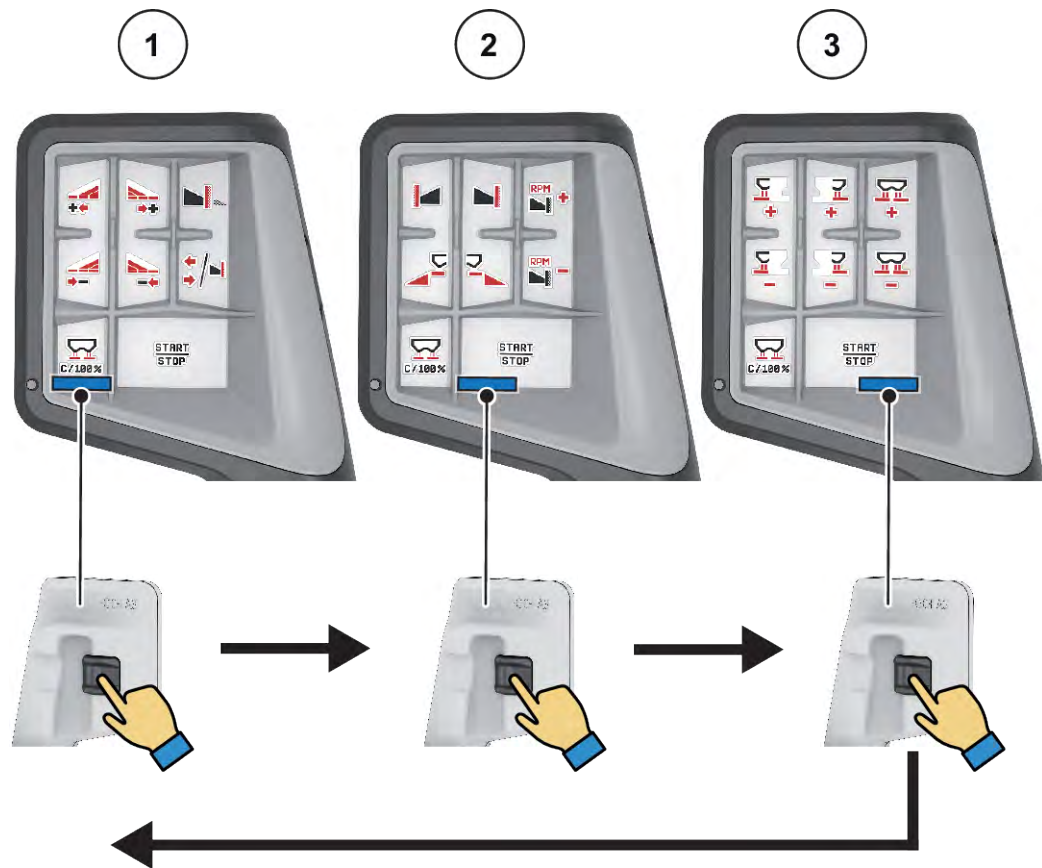

Fig. 39: CCI A3 joystick, operating level display

- [1] Level 1 active
- [2] Level 2 active

- [3] Level 3 active

#### ■ CCI A3 joystick button functions

The joystick offered is pre-programmed with specific functions at the factory.



The meaning and function of the icons can be found in Chapter 2.2 *Library of icons used*.

Please note that the functions of the buttons vary depending on machine type (AXIS-M, AXIS-H).



Fig. 40: Button functions Level 1



Fig. 41: Button functions Level 2



Fig. 42: Button functions Level 3



If you would like to adjust the button functions on the three levels, please note the instructions in the joystick operator's manual.

### 4.13.3 WIFI module

#### ■ *Special equipment*

A WiFi module can be used for communication between a smartphone and the ECU. The following functions are possible:

- Transmission of information from the fertilizer charts app to the ECU. This way, the fertilizer settings no longer need to be entered manually.
- Transmission of the residual material weight display from the ECU on the smartphone.



*Fig. 43: WiFi module*



You can find more information on assembly of the WiFi module and communication with the smartphone in the WiFi module assembly instructions.

- The WiFi password is: **quantron**.

## 5 Spreading operation with AXIS-PowerPack

### 5.1 Overloading

#### 5.1.1 Overloading in automatic operating mode

Overloading is fully automatic and always in the same sequence.



The sensor conditions and overloading can be observed on the operating screen. However, the messages are displayed without sound.

#### Requirement:

- The automatic operating mode is active.
  - See 4.7.3 *Overloading function operating mode*

Function/control	Operating screen display
<ul style="list-style-type: none"> <li>▶ Press Spreading disc start. The conveyor belt starts up. The pre-metering slides open automatically. The PowerPack container fills up. Once the maximum filling quantity is reached, the belt stops automatically.</li> </ul>	
<ul style="list-style-type: none"> <li>▶ Spreading operation start.</li> </ul>	
<ul style="list-style-type: none"> <li>▶ Start spreading.</li> </ul>	<p>156 mm      157 mm</p>
<p>The overload runs continuously depending on the spread quantity. The belt speed and pre-metering setting are automatically adjusted.</p>	



Function/control	Operating screen display
<ul style="list-style-type: none"> <li>▶ Press the start/stop key at the end of work.</li> <li>▶ Stop spreading discs.</li> </ul>	
<p>The pre-metering slides automatically close as soon as the spreading discs have stopped.</p>	

### 5.1.2 Overloading in manual operating mode





Overloading is started and stopped by pressing the Start overloading key if a spreader side is empty. The sensor conditions signal the required steps.

**Requirement:**

- The manual operating mode is active.
  - See *Manual (AXIS-PowerPack only)*
- The spreading operation is started.

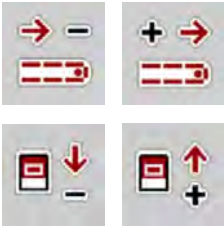
Function/control	Operating screen display
<p>One of both level sensors (LLST or LRST) reports empty.</p>	
<ul style="list-style-type: none"> <li>▶ Press Start overloading.</li> </ul>	
<p>Overloading is active.</p>	







Function/control	Operating screen display
<ul style="list-style-type: none"> <li>▶ Open the pre-metering slides.</li> <li>▶ The conveyor belt starts up simultaneously.</li> <li>▶ Fertiliser flow runs into the spreading unit hopper.</li> </ul>	
<ul style="list-style-type: none"> <li>▶ Adjust the conveyor belt speed and the opening of the pre-metering slides.</li> </ul>	
Both level sensors (LLST or LRST) are dampened.	
The overflow is reached.	
<ul style="list-style-type: none"> <li>▶ Press Start overloading.</li> </ul> <p>The conveyor belt is stopped. Close the pre-metering slides.</p>	
Overloading is completed.	

## 5.2 Fertilizer spreading

### 5.2.1 Working with sections

#### ■ Displaying the spreading type in the operating screen

The machine control unit offers 4 different spreading types for the spreading operation of the AXIS EMC machine. These settings can be configured directly in the working screen. During the spreading operation, you can switch between the spreading types in order to optimally adapt to the field requirements.

Button	Spreading type
	Activate section on both sides
	Section on the left, boundary spreading function on the right possible
	Section on the right, boundary spreading function on the left possible
	<b>AXIS-H only</b> Boundary spreading function on both sides

- ▶ Press the function key several times until the desired spreading type is displayed.

You can spread fertilizer to sections on one or both sides, to adapt the full spreading width to the field requirements. Every spreading side can be set continuously in the automatic mode and to a maximum of 4 steps in the manual mode.



- ▶ Press limited border spreading/sections toggle key.

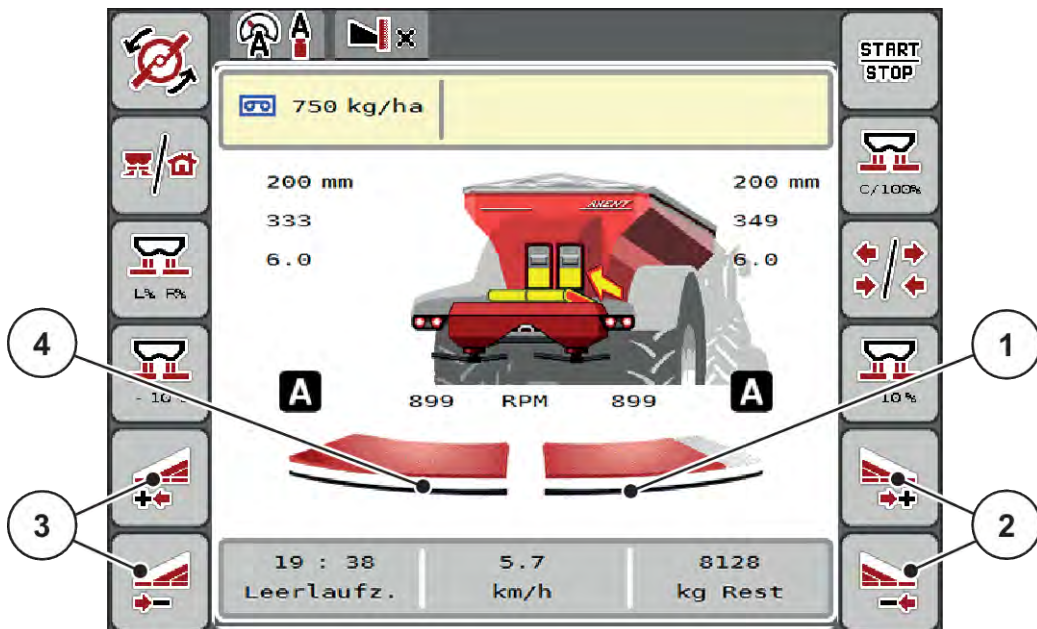

Fig. 44: Working screen: Sections with 2 sections

- [1] The right section is reduced to several steps.
- [2] Function keys for increasing or reducing spreading width on the right
- [3] Function keys for increasing or reducing spreading width on the left
- [4] The left spreading side spreads across the entire half.



- Each section can be reduced or increased in steps.
- Section control is possible from the outside to the inside or vice versa. See *Fig. 45 Automatic section control*

We recommend restarting the terminal in the following cases:

- You have changed the working width.
- You have opened a different fertilizer chart entry.

After restarting the terminal, the section display changes to match the new settings.

- ▶ Press the Reduce left spreading width or the Reduce right spreading width function key.  
*The section of the spreading side will be reduced by one step.*
- ▶ Press the Increase left spreading width function key or the Increase right spreading width function key.  
*The section of the spreading side will be increased by one step.*



The sections are **not** graded proportionally. The VariSpread spreading width assistant sets the spreading widths automatically.

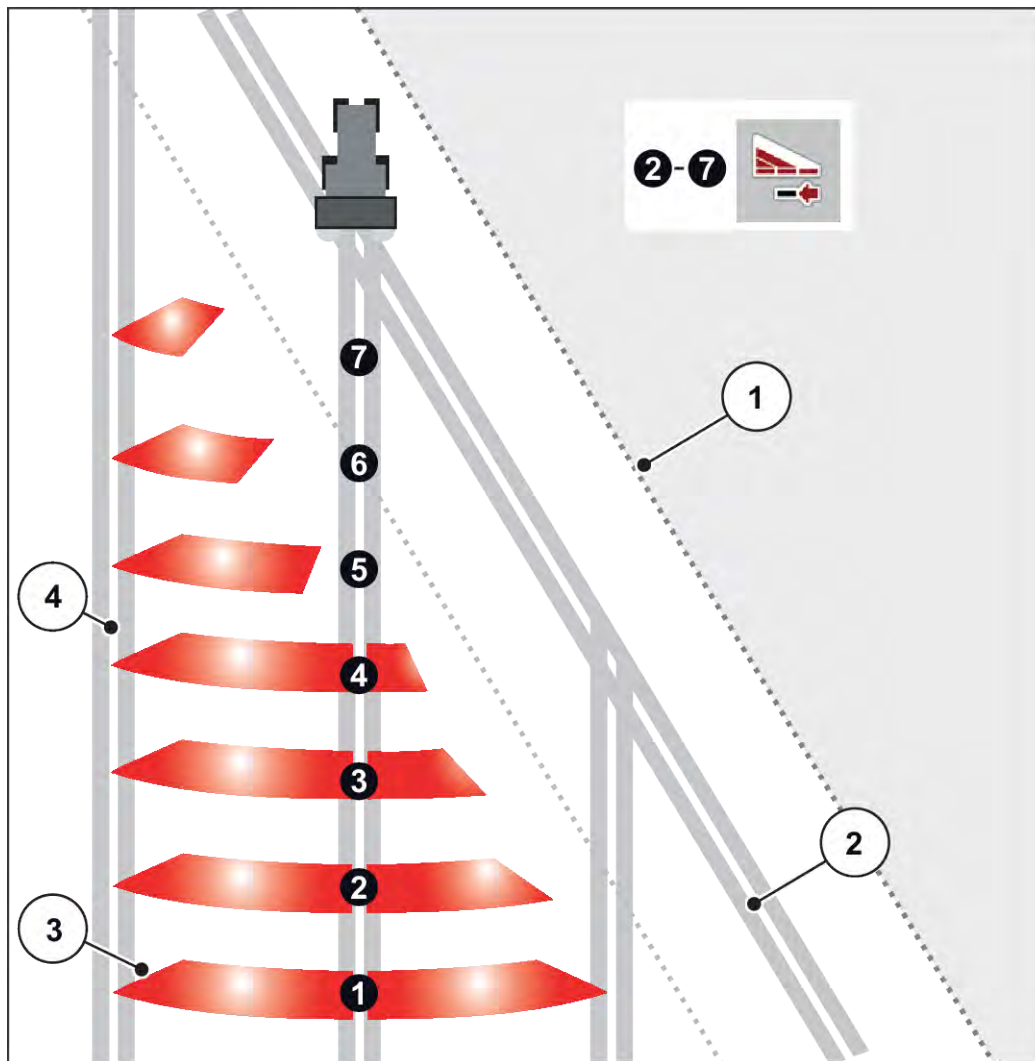

Fig. 45: Automatic section control

- [1] Field edge
- [2] Headlands tramline
- [3] Sections 1 to 4: Section reduction on the right hand side  
Sections 5 to 7: further section reductions
- [4] Tramline in the field

### ■ Spreading operation with one section and in boundary spreading mode

During spreading operation, the sections can be changed gradually and limited border spreading can be deactivated. The figure below shows the operating screen with boundary spreading activated and a section activated.

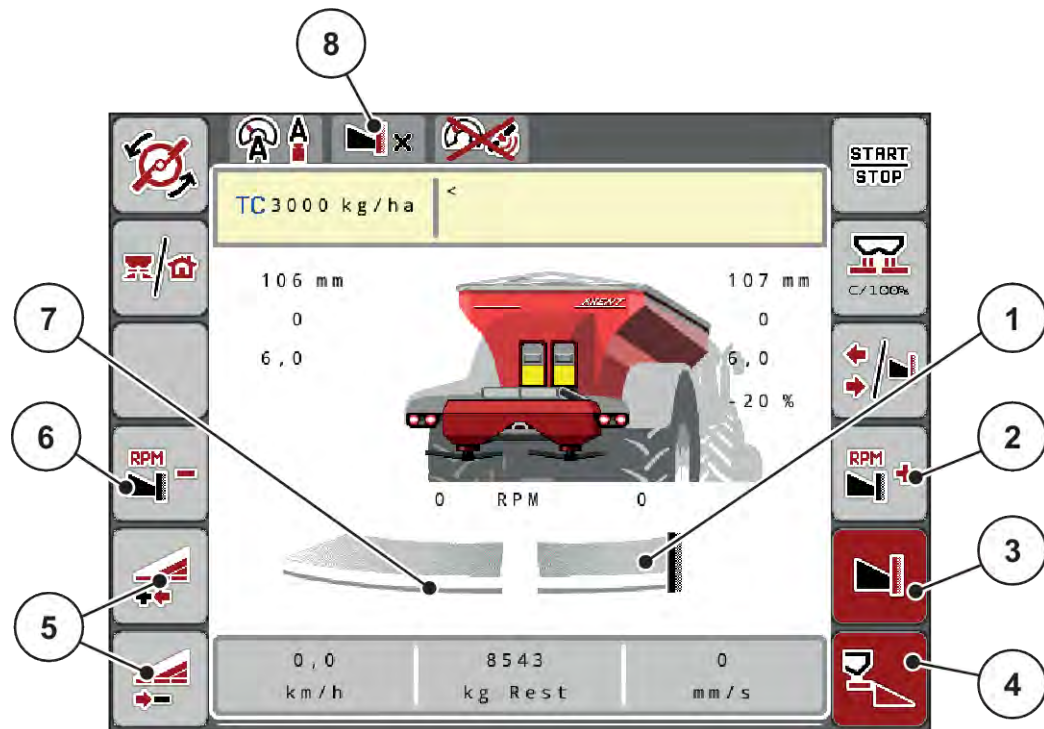

Fig. 46: Operating screen with one section on the left, border spreading side on the right

- |  |  |
|--|--|
| [1] Spreading side on the right in the boundary spreading mode             | [5] Reduce or increase left section                                      |
| [2] Increase the spreading disc speed on the limited border spreading side | [6] Reduce the spreading disc speed on the limited border spreading side |
| [3] Boundary spreading mode is activated                                   | [7] Left section adjustable in 4 steps                                   |
| [4] Right spreading side is activated                                      | [8] The current boundary spreading mode is Limited bd.                   |

- The application rate on the left is set to the full working width.
- The **Right limited border spreading** function key has been pressed, limited border spreading is active, and the application rate is reduced by 20%.
- Press the **Reduce left spreading width** function key in order to reduce the section.
- If you press the **C/100 %** function key, the full working width will be reapplied immediately.
- By pressing the Right limited border spreading function key, the boundary spreading function is deactivated.



The limited border spreading function is also possible in automatic mode with GPS Control. The border spreading side must be manually operated at all times.

- See 5.2.7 GPS control.

## 5.2.2 Spreading with the automatic operating mode (AUTO km/h + AUTO kg)



The AUTO km/h + AUTO kg operating mode allows for continuous regulation of the application rate during the spreading operation. The mass flow control is corrected at regular intervals on the basis of this information. This way, fertilizer metering can be optimized.



The AUTO km/h + AUTO kg operating mode is preselected as the standard factory default.

### Requirements for spreading:

- The AUTO km/h + AUTO kg operating mode is active (See 4.7.1 *AUTO/MAN mode*).
- The fertilizer settings are defined:
  - Application rate (kg/ha)
  - Working width (m)
  - Spreading disc
  - Normal disc speed (RPM)

- ▶ Fill the hopper with fertilizer.

### **! WARNING!**

#### **Risk of injury caused by ejected fertilizer**

Ejected fertilizer may cause severe injury.

- ▶ Make sure nobody is present in the spreading zone of the machine before switching on the spreading discs.

### AXIS-M EMC only:



Start or stop the transmission **at low PTO speeds only**.



- ▶ **AXIS-H only:** Press **Spreading disc start**.
- ▶ Press the enter key to clear the alarm message. See 7.1 *Meaning of the alarm messages*.  
*The Idle measurement screen is displayed.*  
*The Idle measurement starts automatically. See 5.2.3 Idle measurement.*



- ▶ Press Start/Stop  
*The spreading starts.*



We recommend displaying the flow factor in the working screen (refer to 2.1.2 *Display fields*), in order to monitor the mass flow control while spreading.



In case of any problems with flow factor control (clogging, ...), after troubleshooting at a standstill, switch to the Fertilizer settings menu and enter the flow factor 1.0.

### Resetting the flow factor

If the flow factor has fallen below the minimum value (0.4 and/or 0.2), alarm no. 47 and/or 48 appears. See 7.1 *Meaning of the alarm messages*.

## 5.2.3 Idle measurement

### ■ Automatic idle measurement

In order to achieve a high control accuracy, the EMC control must regularly measure and store the idling pressure.

The idle measurement for the determination of the idling pressure will start when the system is restarted.

It will also automatically start the idle measurement under the following conditions:

- The defined period since the last idle measurement has expired.
- You have made changes in the Fertilizer settings menu (RPM, type of spreading disc).

During the idle measurement, the following window appears.

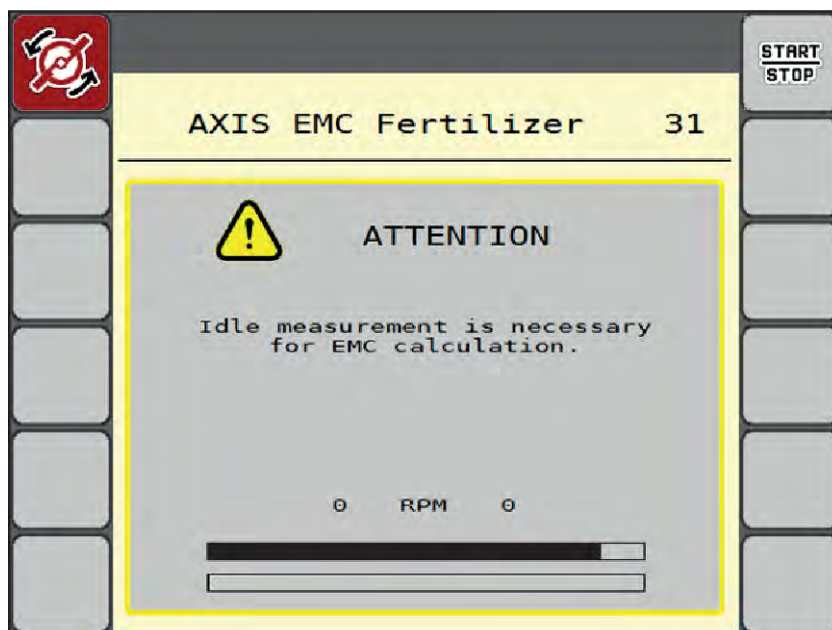

Fig. 47: Alarm display of idle measurement

When starting the spreading disc for the first time, the machine control adjusts the idling torque of the system. See 7.1 Meaning of the alarm messages.



If the alarm message is displayed repeatedly even though the transmission oil is warm:

- Compare the installed spreading disc with the type entered in the Fertiliser settings menu. If required, adjust the type.
- Check the spreading disc for tight seat. Re-tighten the wheel nut
- Check the spreading disc for damage. Replace the spreading disc.

Once the idle measurement has been completed, the machine control unit will set the idling time to 19:59 minutes in the display of the working screen.



► Press **Start/Stop**.

*The spreading starts.*

*The idle measurement runs in the background, even if the metering slides are closed. However, no screen is shown on the display. However, no screen is shown on the display.*

Once this idling time has expired, a further idle measurement is started automatically.

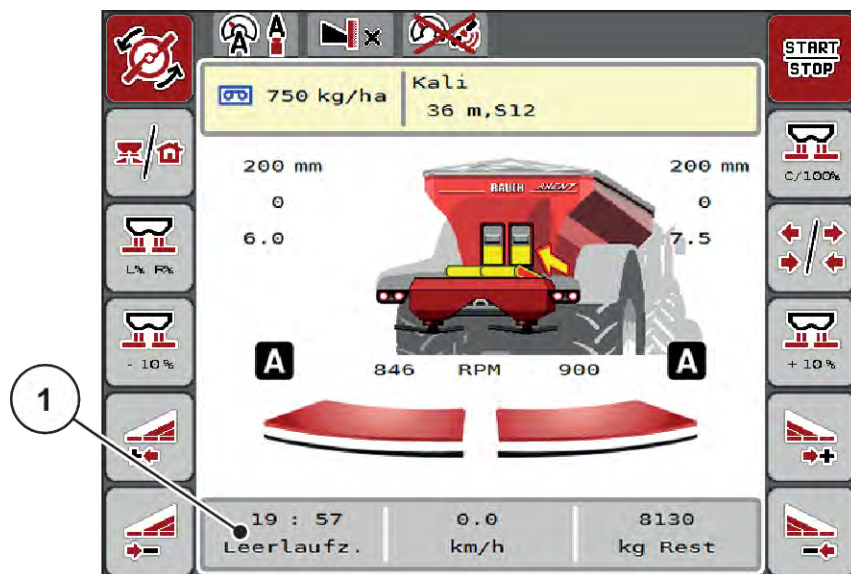

Fig. 48: Display of the idle measurement in the working screen

[1] Time until the next idle measurement



In the case of a reduced spreading disc speed, no idle measurement can be executed if limited border spreading or section reduction are activated!





When the metering slides are closed, an idle measurement is always carried out in the background (without alarm message)!



Do not reduce the engine speed during the idle measurement in the headlands!  
The tractor and hydraulics circuit must have reached their operating temperature!

#### ■ Manual idle measurement

In the case of unusual changes in the flow factor, start the idle measurement manually.



► In the Main menu, press the idle measurement key.

*The idle measurement is started manually.*

### 5.2.4 Spreading with the AUTO km/h operating mode



This working mode is applied by default for machines that lack a weighing system.



In this working mode, the application rate can be reduced down to 1 kg/ha.

#### Requirements for spreading:

- AUTO km/h working mode is active (see 4.7.1 AUTO/MAN mode).
- The fertilizer settings are defined:
  - Application rate (kg/ha),
  - Working width (m)
  - Spreading disc
  - Normal disc speed (RPM)

- ▶ Fill the hopper with fertilizer.



In order to achieve an optimum spreading result in the AUTO km/h working mode, a calibration should be carried out before starting spreading.

- ▶ Carry out a calibration to determine the flow factor or obtain the flow factor from the fertilizer chart and enter the flow factor manually.

**! WARNING!**

**Risk of injury caused by ejected fertilizer**

Ejected fertilizer may cause severe injury.

- ▶ Make sure nobody is present in the spreading zone of the machine before switching on the spreading discs.



- ▶ **AXIS-H only:** Press **Spreading disc start**.



- ▶ Press Start/Stop.

*The spreading starts.*

## 5.2.5 Spreading with the MAN km/h operating mode



If there is no speed signal, the MAN km/h operating mode is active.

- ▶ Access the menu Machine settings > AUTO/MAN mode.
- ▶ Select the MAN km/h menu item.

*The display shows the input window Forward speed.*

- ▶ Enter the value for the forward speed during spreading.
- ▶ Press OK.
- ▶ Configure the fertilizer settings:
  - ▷ Application rate (kg/ha)
  - ▷ Working width (m)
- ▶ Fill the hopper with fertilizer.



In order to achieve an optimum spreading result in the MAN km/h operating mode, a calibration is to be carried out before starting the spreading.

- ▶ Carry out a calibration to determine the flow factor or obtain the flow factor from the fertilizer chart and enter the flow factor manually.



▶ **AXIS-H only:** Press **Spreading disc start**.



▶ Press Start/Stop

*The spreading starts.*



Always observe the set forward speed during spreading.

### 5.2.6 Spreading in the MAN scale operating mode



The MAN scale operating mode, you can manually adjust the metering slider opening during the spreading operation.

The manual mode is only applied:

- If there is no speed signal (radar or wheel sensor not available or defective)
- when spreading slug pellets or fine seeds

The MAN scale operating mode is appropriate for slug pellets and fine seeds since the automatic mass flow control cannot be activated due to the low weight reduction.



For uniform spreading of the spreading material, a constant forward speed must be applied in manual operating mode.

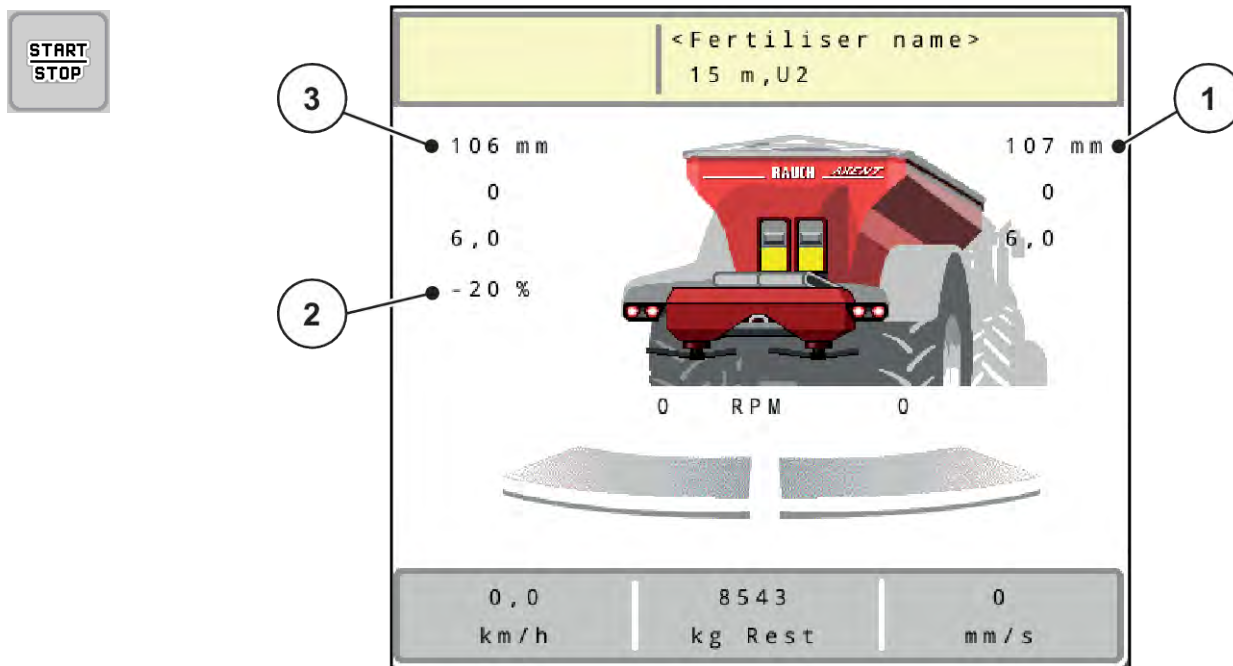

Fig. 49: MAN scale operating screen

- [1] Display of metering slide target value scale
- [2] Display of current metering slide scale
- [3] Application rate adjustment position

- ▶ Access the menu Machine settings > AUTO/MAN mode.
- ▶ Select the MAN scale menu item.
- The Position of dosing slider opening window is displayed.*
- ▶ Enter the scale value for the dosing slider opening.
- ▶ Press OK.
- ▶ Switch to the working screen.

- ▶ **AXIS-H only:** Press **Spreading disc start**.
- ▶ Press Start/Stop.
- The spreading starts.*



- ▶ To change the metering slide opening, press the MAN+ or MAN- function key.
  - ▷ L% R% for selecting the side of the metering slide opening
  - ▷ MAN+ to increase the dosing slider opening or
  - ▷ MAN- to reduce the dosing slider opening.



In order to achieve an optimum spreading result in manual mode as well, we recommend using the metering slide opening and forward speed values provided in the fertilizer chart.

### 5.2.7 GPS control



The machine control unit can be combined with an ISOBUS terminal with SectionControl. Various data is exchanged between both devices to automate control.

The ISOBUS terminal with SectionControl communicates the specifications for the opening and closing of dosing sliders to the machine control unit.

The **A** symbol next to the spreading wedges indicates that the automatic function is enabled. The ISOBUS terminal with SectionControl opens and closes the individual sections depending on the respective position in the field. The spreading starts only after when you press **Start/Stop**.

#### **WARNING!**

##### **Risk of injury due to discharged fertilizer**

The SectionControl function automatically starts the spreading operation without warning.

Ejected fertilizer can harm the eyes and nasal mucous membranes.

There is also a risk of slipping.

- ▶ Ensure that nobody is present in the hazard zone during the spreading operation.

During spreading, **one or several sections** can be closed at any time. If the sections are activated for automatic operation again, the last state requested is restored.

If the ISOBUS terminal with SectionControl is changed from automatic to manual mode, the machine control unit closes the metering slides.



For the use of the **GPS control** functions of the machine control unit, the GPS-Control setting in the Machine settings menu must be activated!

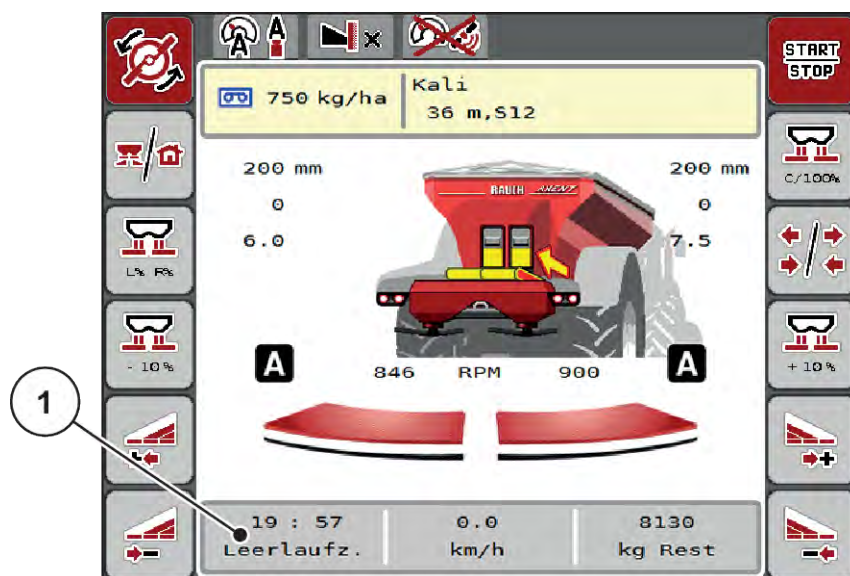

Fig. 50: Spreading operation display in the operating screen with GPS Control

The **OptiPoint / OptiPoint Pro** function calculates the optimal turn on and turn off position for spreading in the headlands based on the settings in the machine control unit; refer to 4.5.10 Calculate *OptiPoint / OptiPoint Pro*.



To ensure correct configuration of the **OptiPoint / OptiPoint Pro** function, enter the correct aerodynamic factor for the fertilizer being used. The aerodynamic factor can be obtained from the fertilizer chart for your machine.

See 4.5.10 Calculate *OptiPoint / OptiPoint Pro*.

#### ■ Turn on distance (m)

The Turn on dist. (m) parameter refers to the switch-on distance [A] measured from the field border [C]. At this position in the field, the metering slides open. This distance depends on the type of fertilizer and represents the ideal switch-on distance for optimized fertilizer distribution.

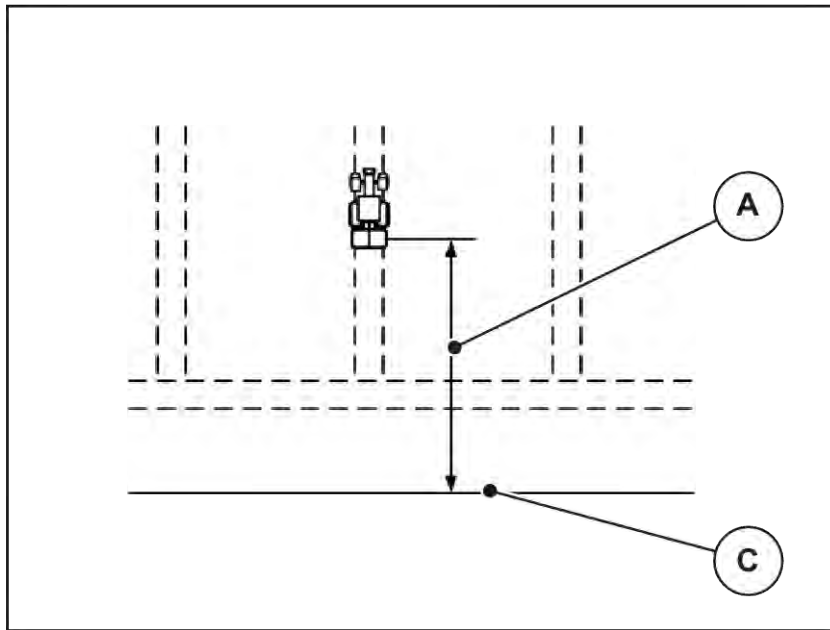

Fig. 51: Distance on (measured from field border)

[A] Turn on distance

[C] Field border

If you want to change the switch-on position in the field, you need to adjust the Turn on dist. (m) value.

- A lower value for this distance means that the switch-on position is closer to the field border.
- A greater value means that the switch-on position is closer to the center of the field.

#### ■ Turn off distance (m)

The Turn off dist. (m) parameter refers to the turn off distance [B] measured from the field border [C]. At this position in the field, the metering sliders start to close.

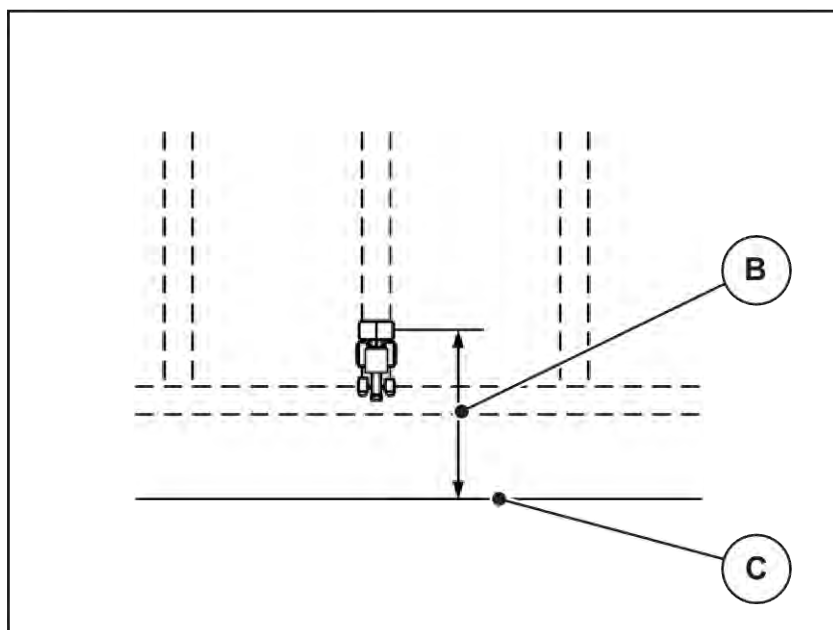

Fig. 52: Distance off (measured from field border)

[B] Turn off distance

[C] Field border

If you want to change the switch-off position, you need to adjust the Turn off dist. (m) accordingly.

- A lower value means that the switch-off position is closer to the field border.
- A greater value means that the switch-off position is closer to the center of the field.

**OptiPoint Pro** limits the switch-off distance to a minimum value depending on the fertilizer settings. The reason for this is the calculation in the section control algorithm.

If you want to turn through the headland track, enter a greater distance in Turn off dist. (m). Here, the adjustment must be as low as possible so that the metering sliders close as soon as the tractor enters the headland track. An adjustment of the switch-off distance may lead to insufficient fertilization around the switch-off positions in the field.









## 6 Spreading operation with the UNIVERSAL PowerPack

### 6.1 Overloading

Overloading is fully automatic and always in the same sequence.

**Requirement:**

- The automatic operating mode is active.
  - See 4.7.3 *Overloading function operating mode*

Function/control	Operating screen display
▶ Press Spreading disc start.	
▶ Spreading operation start. The conveyor belt starts up.	 
Overloading is active.	
▶ Start spreading.	
▶ Press the start/stop key at the end of work. ▶ Stop spreading discs. The overload runs continuously depending on the spread quantity. The belt speed and pre-metering setting are automatically adjusted.	 
The pre-metering slides automatically close as soon as the spreading discs have stopped.	

### 6.2 Spreading lime

When starting the machine control unit, the attached lime spreading unit is automatically detected and the machine control unit switches to lime operation.

Lime operation is speed-dependent: The speed of the conveyor belt and opening of the pre-metering slide are automatically adjusted to the forward speed to ensure even lime spreading.

## 6.2.1 Adjustments

### Entering the application rate

- ▶ Access the menu Fertiliser settings > Appl. rate (kg/ha).  
*The currently applied application rate is displayed.*
- ▶ Enter the desired application rate in the range between 500 kg/ha to 10,000 kg/ha.
- ▶ Press OK.

*The new value is saved in the machine control unit.*

### Setting the working width

- ▶ Access the menu Fertiliser settings > Working width (m).
- ▶ Enter the desired working width in the range between 12 m to 15 m.
- ▶ Press OK.

*The new value is saved in the machine control unit.*

### Operating mode selection

- ▶ Access the menu Machine settings > AUTO/MAN mode.
- ▶ Select the AUTO km/h or MAN km/h menu item.

### Specifying the spreading discs

- ▶ Access the menu Fertiliser settings > Spreading disc.
- ▶ Select spreading disc type **U2**.

*You can start lime operation.*

### 6.2.2 Starting the spreading operation

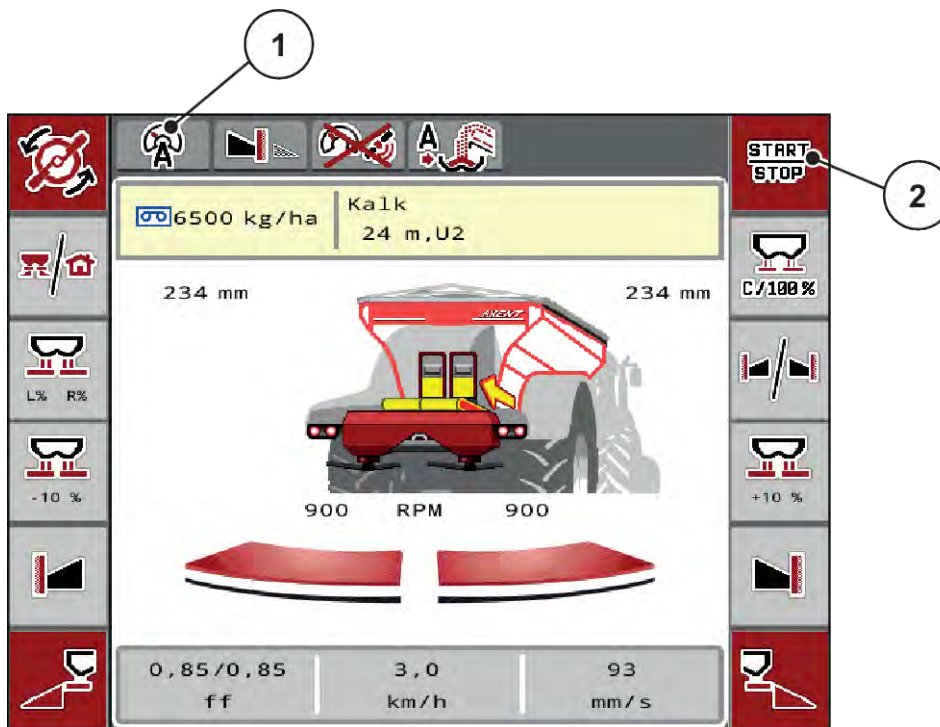









Fig. 53: Operating screen in lime operation

- [1] Symbol of active lime operating mode    [2] Starting the spreading operation  
 AUTO km/h

Function/control	Operating screen display
<p>▶ Press Spreading disc start.</p> <p>The pre-metering slides open automatically.</p>	
<p>▶ Spreading operation start.</p> <p>The conveyor belt starts up.</p>	
<p>▶ Start spreading.</p>	
<p>The speed of the conveyor belt and the pre-metering slide opening are automatically adjusted to the forward speed.</p>	

Function/control	Operating screen display
<p>▶ Press Start/Stop in the headlands. The conveyor belt is stopped. The pre-metering slides remain open.</p>	
<p>▶ Press start/stop again during travel into the field. The conveyor belt is started.</p>	
<p>▶ Press Start/Stop at the end of the operation. The conveyor belt is stopped.</p>	
<p>Overloading is completed. The spreading operation is completed.</p>	

## 7 Alarm messages and possible causes

### 7.1 Meaning of the alarm messages

Various alarm messages can be displayed on the ISOBUS terminal display.

No.	Message in display	Meaning and possible cause
1	Fault in dosing system, stop !	The motor of the metering system cannot reach the specified target value: <ul style="list-style-type: none"> <li>• Blockage</li> <li>• No position feedback</li> </ul>
2	Max. outlet reached! Speed or application rate too high	Metering slide alarm <ul style="list-style-type: none"> <li>• The maximum metering opening is reached.</li> <li>• The set application rate (+/- quantity) exceeds the maximum metering opening.</li> </ul>
3	Flow factor is outside limits	The flow factor must lie within a range between 0.40 and 1.90. <ul style="list-style-type: none"> <li>• The newly calculated or entered flow factor is outside this range</li> </ul>
4	Hopper left empty!	The filling level sensor on the left reports "empty." <ul style="list-style-type: none"> <li>• The left hopper is empty.</li> </ul>
5	Hopper right empty!	The filling level sensor on the right reports "empty." <ul style="list-style-type: none"> <li>• The right hopper is empty.</li> </ul>
15	Memory full, Delete one private fertiliser chart	A maximum of 30 fertilizer types are stored in the memory for the fertilizer charts.
16	Approach drop point Yes = Start	Safety request before the drop point is automatically approached <ul style="list-style-type: none"> <li>• Drop point setting in the menu Fertiliser settings</li> <li>• Fast emptying</li> </ul>

No.	Message in display	Meaning and possible cause
17	Error by setting drop point	<p>The drop point adjustment cannot reach the specified target value.</p> <ul style="list-style-type: none"> <li>• Fault, for instance with the power supply</li> <li>• No position feedback</li> </ul>
18	Error by setting drop point	<p>The drop point adjustment cannot reach the specified target value.</p> <ul style="list-style-type: none"> <li>• Blockage</li> <li>• No position feedback</li> <li>• Calibration test</li> </ul>
19	Defect by setting drop point	<p>The drop point adjustment cannot reach the specified target value.</p> <ul style="list-style-type: none"> <li>• No position feedback</li> </ul>
20	Error at LIN bus participant:	<p>Communication problem</p> <ul style="list-style-type: none"> <li>• Defective cable</li> <li>• Loose plug connector</li> </ul>
21	Spreader overloaded!	<p>For weighing spreaders only: The fertilizer spreader is overloaded.</p> <ul style="list-style-type: none"> <li>• Too much fertilizer in the hopper</li> </ul>
22	Unknown condition Function-Stop	<p>Communication problem with terminal</p> <ul style="list-style-type: none"> <li>• Possible software error</li> </ul>
23	Error by setting TELIMAT	<p>The TELIMAT adjustment cannot reach the specified target value.</p> <ul style="list-style-type: none"> <li>• Blockage</li> <li>• No position feedback</li> </ul>
24	Defect by setting TELIMAT	Defective TELIMAT actuator
25	Activate disc start. Confirm with ENTER	
26	Discs started up without activation	Defective or manually switched hydraulics valve
27	Discs started up without activation	Defective or manually switched hydraulics valve
28	Disc could not start up properly. Deactivate disc start.	<p>Spreading discs do not rotate.</p> <ul style="list-style-type: none"> <li>• Blockage</li> <li>• No position feedback</li> </ul>

No.	Message in display	Meaning and possible cause
29	The agitator motor is overloaded.	The agitator is blocked. <ul style="list-style-type: none"> <li>• Blockage</li> <li>• Defective connection</li> </ul>
30	The discs shall be activated before opening the metering sliders.	Correct software operation <ul style="list-style-type: none"> <li>• Start spreading discs</li> <li>• Open metering slides</li> </ul>
31	Idle measurement is necessary for EMC calculation.	Alarm message before the idle measurement <ul style="list-style-type: none"> <li>• Activate spreading disc start.</li> </ul>
32	Externally controlled parts can be moved. Risk of injury through squeezing and shearing! - Direct ALL persons out of the danger zone - Read the instruction manual Confirm with ENTER	If the machine control unit is activated, components may move unexpectedly. <ul style="list-style-type: none"> <li>• Follow the displayed instructions only if all risks have been eliminated.</li> </ul>
33	Stop the discs and close the metering sliders	You may only switch to the System / Test menu area if the spreading operation has been deactivated. <ul style="list-style-type: none"> <li>• Stop spreading discs.</li> <li>• Close the metering slide.</li> </ul>
39	Manual mode active. Risk of fertiliser overflow.	The message is displayed on switching over from automatic to manual.
45	Error at M-EMC sensors. EMC control deactivated!	The sensor has stopped sending signals. <ul style="list-style-type: none"> <li>• Cable breakage</li> <li>• Defective sensor</li> </ul>
46	Spreading speed error. Observe spreading speed of 450..650 rpm!	The PTO speed is outside the range for the M EMC function.
47	Left dosing error, hopper empty, outflow blocked!	<ul style="list-style-type: none"> <li>• Hopper empty</li> <li>• Outlet blocked</li> </ul>
48	Right dosing error, hopper empty, outflow blocked!	<ul style="list-style-type: none"> <li>• Hopper empty</li> <li>• Outlet blocked</li> </ul>
49	Idle meas. implausible. EMC control deactivated!	<ul style="list-style-type: none"> <li>• Defective sensor</li> <li>• Defective transmission</li> </ul>
50	Idle meas. impossible. EMC control deactivated!	PTO speed not permanently stable

No.	Message in display	Meaning and possible cause
52	Error at hopper cover	<p>The position of the hopper cover could not be reached.</p> <ul style="list-style-type: none"> <li>• Blockage</li> <li>• Defective actuator</li> </ul>
53	Defect at hopper cover	<p>The hopper cover actuator cannot reach the target value for the movement.</p> <ul style="list-style-type: none"> <li>• Blockage</li> <li>• Defective actuator</li> </ul>
57	Error at hopper cover	<p>The hopper cover actuator cannot reach the target value for the movement.</p> <ul style="list-style-type: none"> <li>• Blockage</li> <li>• No position feedback</li> </ul>
71	Impossible to reach disc speed	<p>The spreading disc speed is not within the 5 % target range.</p> <ul style="list-style-type: none"> <li>• Problem with oil supply</li> <li>• Proportional valve spring is jammed.</li> </ul>
72	Error at SpreadLight	<p>Power supply is too high; the operating lights will be switched off.</p>
73	Error at SpreadLight	<p>Overload</p>
74	Defect at SpreadLight	<p>Connection error</p> <ul style="list-style-type: none"> <li>• Defective cable</li> <li>• Loose plug connector</li> </ul>
75	Conveyor belt speed could not be reached	<p>The conveyor belt has not reached the target speed within 5 s.</p>
76	Error at left pre-metering slider cylinder	<p>The position at the left pre-metering slide could not be reached.</p> <ul style="list-style-type: none"> <li>• Blockage</li> <li>• Hydraulics cylinder defective</li> </ul>
77	Error at right pre-metering slider cylinder	<p>The position at the right pre-metering slide could not be reached.</p> <ul style="list-style-type: none"> <li>• Blockage</li> <li>• Hydraulics cylinder defective</li> </ul>
78	AXENT empty	<p>The hopper is empty.</p>



No.	Message in display	Meaning and possible cause
79	Cover open!	Switch is not operated, the overloading function is not possible. The safety hood is open and not properly closed.
80	Stop loading!	The message is displayed on switching over to the system/test menu during operation. <ul style="list-style-type: none"> <li>• Stop spreading operation.</li> <li>• Access the menu System / Test.</li> </ul>
81	Low oil level!	Insufficient oil level in the hydraulic circuit. <ul style="list-style-type: none"> <li>• Stop the machine and refill oil.</li> </ul>
82	Type of machine modified. Spreading error possible. New configuration required!	The operating modes cannot be combined with certain machine types <ul style="list-style-type: none"> <li>▶ Restart the machine control unit when changing machine type.</li> <li>▶ Implement machine settings.</li> <li>▶ Load fertilizer chart for the machine type.</li> </ul>
83	Reduce oil temp.	The oil temperature of the on-board hydraulic system has reached the preset alarm limit.
88	Error at disc speed sensor	The spreading disc RPM could not be determined <ul style="list-style-type: none"> <li>• Cable breakage</li> <li>• Defective sensor</li> </ul>
89	Disc speed too high	Alarm of the spreading disc sensor <ul style="list-style-type: none"> <li>• The maximum RPM is reached.</li> <li>• The set RPM exceeds the maximum admissible value.</li> </ul>
90	AXMAT-Stop	The AXMAT function is automatically deactivated and no longer regulates. <ul style="list-style-type: none"> <li>• More than 2 sensors are reporting an error.</li> <li>• Communication error</li> </ul>

No.	Message in display	Meaning and possible cause
93	This disc type requires a modification on the TELIMAT device. Please follow the mounting instructions!	Spreading disc S1 is installed and the machine is equipped with TELIMAT. Spreading errors possible during border spreading <ul style="list-style-type: none"> <li>This spreading disc type requires conversion of the TELIMAT device.</li> </ul>
111	Fault on LS valve	Power supply current is too high; the LS valve is switched off.
112	Fault on LS valve	Overload
113	Fault on LS valve	The LS valve has not be detected. <ul style="list-style-type: none"> <li>Cable breakage</li> <li>LS valve defective</li> </ul>

## 7.2 Fault/alarm

An alarm message is displayed with a red frame and with a warning symbol.

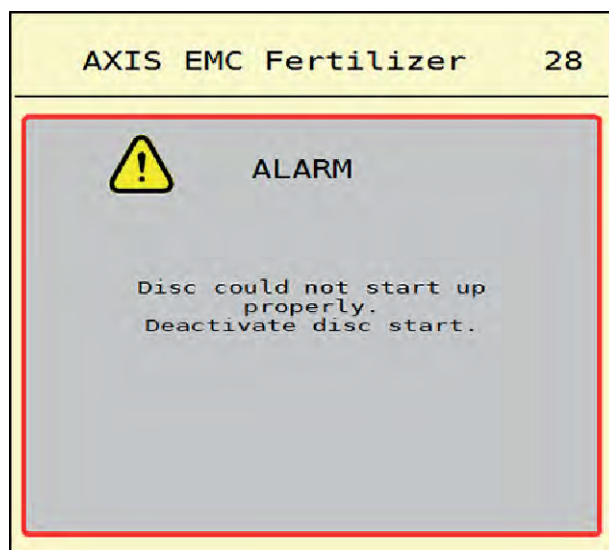

Fig. 54: Alarm message (example)

### 7.2.1 Acknowledging an alarm message

#### Acknowledging an alarm message:

- ▶ Rectify the cause of the alarm message.  
Observe the operating manual for the mineral fertilizer spreader. See also 7.1 *Meaning of the alarm messages.*
- ▶ ACK Press



In the case of different ISOBUS terminals, acknowledging the alarm messages may differ.

You can use various keys to acknowledge other messages with a yellow frame:

- Enter
- Start/Stop

For this purpose, follow the instructions on screen.

## 8 Special equipment

Illustration	Designation
 A black cable with a cylindrical metal sensor head and a connector at the other end.	Level sensor
 A black joystick with a grey top panel featuring several buttons and a small display. The top panel has a 'STRICT STOP' label and a 'C/100%' label.	CCI A3 joystick
 A black rectangular module with a cable and a connector.	WiFi module

## 9 Guarantee and warranty

RAUCH devices are manufactured using modern production methods and with the greatest of professional care, and are subjected to numerous inspections.

This is why RAUCH is offering a 12 month warranty if the following conditions are met:

- The warranty starts on the date of purchase.
- The warranty covers material or manufacturing defects. We are liable for third-party products (hydraulics, electronics) only to the extent of the relevant manufacturer. During the warranty period, manufacturing and material defects will be rectified free of charge with the replacement or repair of the affected parts. Other rights extending beyond the above, such as claims for conversion, reduction, or replacement for reasons of damage not suffered by the supplied product are explicitly excluded. Warranty services are provided by authorized workshops, by RAUCH factory representatives or the factory itself.
- Consequences of natural wear, dirt, corrosion, and all defects caused by improper use as well as external influences shall be excluded from the warranty. Any unauthorized repairs or changes to the original condition will void the warranty. The warranty is voided if any spare parts other than genuine RAUCH spare parts were used. Therefore, the directions in the operating manual must be observed. Please contact our company representatives of the parent company if you have any questions or doubts. Warranty claims must be submitted to the company within 30 days at the latest after the damage has occurred. The date of purchase and the machine number must be indicated. If repairs under the warranty are required, they must be carried out by the authorized workshop only after consultation with RAUCH or the company's appointed representatives. The warranty period will not be extended by warranty work. Transport damage is not a factory defect and is therefore not covered by the manufacturer's warranty manufacturer.
- Claims for damage other than to the RAUCH devices will not be accepted. This also means that no liability will be accepted for damage resulting from spreading errors. Unauthorized modifications of the RAUCH devices may result in consequential damage, for which the manufacturer will not accept any liability. The manufacturer's exclusion from liability will not apply in the case of willful intent or gross negligence by the owner or a senior employee, and in cases where – according to the product liability law – there is liability for personal injury or material damage to privately used objects in the event of defects in the supplied product. The exclusion from liability will also not apply if characteristics are missing that are explicitly guaranteed, if the purpose of their guarantee was to protect the purchaser against damage not suffered by the supplied product itself.

**RAUCH Streutabellen**  
**RAUCH Fertilizer Chart**  
**Tableaux d'épandage RAUCH**  
**Tabele wysiewu RAUCH**  
**RAUCH Strooitabellen**  
**RAUCH Tabella di spargimento**  
**RAUCH Spredetabellen**  
**RAUCH Levitystaulukot**  
**RAUCH Spridningstabellen**  
**RAUCH Tablas de abonado**



<https://streutabellen.rauch.de/>



**RAUCH Landmaschinenfabrik GmbH**

Victoria Boulevard E 200  
77836 Rheinmünster · Germany



info@rauch.de · www.rauch.de

Phone +49 (0) 7229/8580-0