



# MDS







**Wichtig**

**de**

#### Sicherheits- und Unfallverhütungsvorschriften

Vor etwaigen Einstell- oder sonstigen Arbeiten z.B. Reinigung, Wartung, Umbau oder Anbau **Zapfwelle ausschalten, Motor abstellen und Zündschlüssel abziehen.**

**Beachten Sie auch die Sicherheitshinweise in der Betriebsanleitung zu diesem Zubehör!**



**Important**

**en**

#### Accident prevention and safety regulations

**Always disconnect the PTO (power take-off) , shut down the engine and remove the ignition key** before carrying out any adjustments or other work on the machine (e.g. cleaning, maintenance, additions or modifications).

**Refer also to the safety instructions in the user manual provided with the fittings.**



**Important**

**fr**

#### Consignes de sécurité et de prévention des accidents

Avant d'éventuels travaux de réglage ou autres, par exemple nettoyage, entretien, transformation ou ajout, **désactiver la prise de force, arrêter le moteur et retirer la clé de contact.**

**Respecter également les consignes de sécurité figurant dans le manuel d'utilisation de cet accessoire !**



**Importante**

**it**

#### Norme di sicurezza e antinfortunistiche

Prima di qualsiasi intervento di regolazione o lavoro, ad es. pulizia, manutenzione, modifica o montaggio

**disinserire la presa di forza, spegnere il motore ed estrarre la chiave dell'accensione.**

**Rispettare anche le norme di sicurezza contenute nel manuale d'uso di questo accessorio!**



**Belangrijk**

**nl**

#### Veiligheids- en ongevalpreventievoorschriften

Voor alle instel- of andere werkzaamheden, bijv. reiniging, onderhoud, ombouwen of aanbouwen **de aftakas uitschakelen, de motor uitzetten en de contactsleutel uit het contactslot trekken.**

**Neem ook de veiligheidsinstructies in de bedieningshandleiding ten aanzien van dit accessoire in acht!**



**Viktigt**

**sv**

#### Föreskrifter om säkerhet och olycksförebyggande åtgärder

Före inställningar eller andra arbete som t.ex. rengöring, underhåll, ombyggnad eller montering **Stäng av kraftuttaget och motorn samt ta ut tändningsnyckeln.**

**Beakta även säkerhetsinformationen i bruksanvisningen för de aktuella tillbehören!**



**Importante**

**es**

#### Normativa para la seguridad y prevención de accidentes

Previo a las labores de ajuste o de cualquier otro tipo como, p. ej., limpieza, mantenimiento, modificación o montaje,

**desacople el eje de toma de fuerza, apague el motor y extraiga la llave de encendido.**

**¡Observe asimismo las indicaciones de seguridad contenidas en el manual de instrucciones de este accesorio!**



**Fontos**

**hu**

#### Biztonsági és balesetvédelmi előírások

A gép beállítása vagy egyéb munkálatai előtt (pl. tisztítás, karbantartás, átépítés vagy felszerelés) **kapcsolja ki az erőleadó tengelyt, állítsa le a motort és húzza ki a gyújtáskulcsot.**

**Ügyeljen a tartozék kezelési útmutatójában található biztonsági tudnivalók betartására.**



Viktig

no

#### Sikkerhets- og ulykkesforebyggende forskrifter

Før eventuelle innstillings- eller andre arbeider som f.eks. rengjøring, vedlikehold, ombygging eller påbygging:

**Koble ut tappakselen, slå av motoren og trekk ut tenningsnøkkelen.**

**Følg også sikkerhetsanvisningene i bruksanvisningen for dette tilbehøret!**



Tärkeätä

fi

#### Turvallisuusmääräykset

**Voimanottoakseli on kytkettävä irti, moottori sammutettava ja virta-avain vedettävä irti virtalukosta** ennen kaikkia säätö- tai muita toimia kuten esim. puhdistusta, huoltoa, muutostöitä tai lisälaitteiden kytkemistä.

**Noudata myös lisävarusteiden käyttöohjeissa olevia turvallisuuteen liittyviä neuvoja!**



Wichtig

lb

#### Virschräfte fir d'Sécherheet a fir Onfälle ze vermeiden

Virun eventuellen Astellungen oder aneren Aarbechten, wéi z.B. Botzen, Manutentioun, Ännerungen oder Erweiterungen,

**d'prise de force ausmaachen, de Motor ausmaachen an de Schlëssel erauszéien.**

**Halt lech w.e.g. och un d'Indikatioune fir d'Sécherheet, déi Dir am Handbuch vun dësem Accessoire fannt!**



Ważne

pl

#### Przepisy bezpieczeństwa i zapobiegania wypadkom

Przed rozpoczęciem wszelkich prac nastawczych lub innych, np. czyszczenie, konserwacja, przebudowa lub montaż

**Wyłączyć wał odbioru mocy, zatrzymać silnik i wyciągnąć kluczyk ze stacyjki.**

**Przestrzegać również wskazówek dotyczących bezpieczeństwa zamieszczonych w instrukcji obsługi tego urządzenia!**



Vigtigt

da

#### Forskrifter om sikkerhed og forebyggelse af ulykker

Før eventuel indstilling eller andet arbejde, f.eks. rengøring, vedligeholdelse, ombygning eller påmontering af dele, skal **kraftudtaget frakobles, motoren standses og tændingsnøglen trækkes ud.**

**Følg også sikkerhedsanvisningerne i driftsvejledningen til dette tilbehør!**



Važno

hr

#### Propisi o sigurnosti i sprječavanju nezgode

Prije eventualnih podešavanja ili ostalih radova npr. čišćenja, održavanja, prepravljanja ili montaže

**isključite prijenosnik snage, ugasite motor i izvucite ključeve za paljenje.**

**Uvažite i upute o sigurnosti iz uputa za upotrebu ovog pribora!**



Önemli

tr

#### Güvenlik ve kaza önleme ile ilgili talimatlar

Muhtemel ayar çal işmlarından veya diğer işlerden örn. temizlik, bakım, tadilat veya montaj **muylu mili kapat in, motoru durdurun ve kontak anahtarını çıkarın.**

**Bu aksesuarın kullanım kılavuzundaki emniyet talimatlarını da dikkate alın !**



Importante

pt

#### Normas de segurança e prevenção de acidentes

Antes de qualquer trabalho de ajuste ou de outra natureza, como limpeza, manutenção, modificação ou montagem,

**desligar o eixo de tomada de força, desligar o motor e retirar a chave da ignição.**

**Devem também ser tidas em conta as recomendações de segurança constantes do manual de instruções deste acessório!**



**Pomembno**

### Varnostni predpisi in predpisi za preprečevanje nesreč

Pred namestitvijo ali drugimi deli ali posegi, na primer čiščenjem, vzdrževanjem, rekonstrukcijo ali montažo, **izklopite kardansko gred, zaustavite motor in izvlecite ključ za vžig.**

**sl**

**Upoštevajte tudi varnostne napotke v navodilih za uporabo te opreme!**



**Dôležitě**

### Bezpečnostné predpisy a predpisy na prevenciu úrazov

Pred prípadnými nastavovacími alebo inými prácami, ako napr. čistením, údržbou, rekonštrukciou alebo pristavovaním, **vypnite vývodový hriadeľ, odstavte motor a vyťahnite kúč zo zapalovania.**

**sk**

**Dbajte pritom tiež na bezpečnostné pokyny v návode na obsluhu k tomuto príslušenstvu!**



**Tähtis**

### Ohutus- ja ettevaatuseeskirjad

Enne võimalikke seadistus- vm töid, näiteks puhastamine, hooldus, ümber- või juurdeehitus, **tuleb kaitusvõll välja lülitada, mootor seisata ja süütevõti eemaldada.**

**et**

**Järgige ka kõnealuse varustuse Kasutusjuhendis sisalduvaid ohutusjuhiseid!**



**Svarbu**

### Saugos ir atsargumo priemonių instrukcijos

Montuojant arba atliekant panašius darbus, pvz., valant, atliekant techninę priežiūrą, atliekant permontavimo arba papildomų įrenginių montavimo darbus **būtina atjungti papildomą ają pavarą, išjungti variklį ištraukti užvedimo raktelį.**

**lt**

**Taip pat laikykitės šio įrenginio eksploatavimo vadove pateiktų saugos nurodymų!**



**Svarīgi**

### Norādes drošībai un nelaiemes gadījumu novēršanai.

Pirms iespējamiem iestatīšanas vai citiem darbiem, piemēram, tīrīšanas, apkopes, pārbūves vai piebūvēšanas **atslēdziet jūgvārpstu, izslēdziet motoru un izņemiet aizdedzes atslēgu.**

**lv**

**Ievērojiet arī drošības norādes, kas minētas šī piederuma ekspluatācijas instrukcijā!**



**Důležitě**

### Bezpečnostní předpisy a předpisy pro ochranu před úrazem

Před případným seřizováním nebo jinou prací, např. čištění, údržba, přestavba nebo montáž, **vypněte vývodovou hřídel, vypněte motor a vytáhněte klíček ze zapalování.**

**cs**

**Dodržujte také bezpečnostní pokyny v návodu k obsluze tohoto příslušenství!**



**Važno**

### Propisi za zaštitu na radu i sprečavanje nesreća

Pre eventualnih podešavanja ili ostalih radova npr. čišćenja, održavanja, prepravljanja ili montaže **isključite prenosnik snage, ugastite motor i izvucite ključeve za paljenje.**

**sr**

**Obratite pažnju i na uputstva za zaštitu na radu iz uputstva za upotrebu ovog pribora!**



**Tábhachtach**

### Rialúcháin um shábháilteacht agus seachaint timpistí

Déan i gcónaí an Cumhachtdhúiseoir a dhínascadh, an t-inneall a mhúchadh agus an eochair adhainte a bhaint as sula ndéanann tú aon choigeartú nó obair eile ar an meaisín (m.sh. glanadh, cothabháil, breiseáin nó mionathruithe).

**ga**

**Féach freisin na treoracha sábháilteachta i lámhleabhar an úsáideora, a cuireadh ar fáil i dteannta na bhfeisteas seo.**



Áriðandi

is

### Öryggisleiðbeiningar og fyrirmæli vegna slysaþattu

Á undan stillingavinnu eða öðru viðhaldi t.d. hreinsun, viðgerðum, breytingum eða viðbótum verður að **taka drifskafið úr sambandi, slökva á mótornum og fjarlægja kveikjulykil.**

Farið einnig eftir öryggisleiðbeiningum í notendahandbókinni sem fylgir þessum búnaði!



Σημαντικό

el

### Οδηγίες ασφαλείας και πρόληψης ατυχημάτων

Πριν από κάθε ρύθμιση ή οποιαδήποτε άλλη εργασία, όπως π.χ. καθαρισμός, συντήρηση, τροποποίηση ή επέκταση

**απενεργοποιήστε τον κινητήριο άξονα και τον κινητήρα και τραβήξτε το κλειδί ανάφλεξης.**

**Λάβετε υπόψη και τις υποδείξεις ασφαλείας του εξοπλισμού αυτού, που περιέχονται στο παρόν εγχειρίδιο λειτουργίας!**



Важно

ru

### Предписания по технике безопасности и правила безопасности

Перед выполнением настройки или других работ, например чистки, технического обслуживания, переоборудования или установки, **выключите вал отбора мощности, отключите двигатель и выньте ключ зажигания.**

**Выполняйте указания по технике безопасности, содержащиеся в инструкции по эксплуатации этих принадлежностей!**



Увага!

uk

### Вказівки з техніки безпеки та запобігання нещасним випадкам

Перед виконанням будь-яких установочних чи інших робіт, таких як чищення, технічне обслуговування, монтаж або демонтаж, **необхідно зупинити розподільчий вал, вимкнути мотор та витягнути ключ запалення.**

**Також дотримуйтеся вказівок з техніки безпеки, що подані в інструкції з користування обладнанням!**



Важно

bg

### Правила по техника на безопасност и охрана на труда

Преди евентуални работи по настройката или други работи, напр. почистване, поддръжка, реконструкция или пристрояване

**изключете силоотводния вал, спрете двигателя и извадете ключа за запалването.**

**Съблюдавайте и инструкциите по безопасността в ръководството за работа към тези принадлежности!**



Important

ro

### Prevederi de siguranță și prevenire a accidentelor

Înainte de orice lucrări de instalare sau de alt fel, cum ar fi curățarea, întreținerea, modificarea sau montarea de piese suplimentare **a se decupla priza de putere, a se opri motorul și a se scoate cheia de contact.**

**Respectați și indicațiile de siguranță din manualul de utilizare al acestui accesoriu!**



重要

ja

### 安全規定および 事故防止規定

調整作業または清掃、メンテナンス、改造、取り付けなどの作業を行う際は、あらかじめ動力取り出し装置の電源を切り、エンジンを停止させ、イグニッションキーを抜いてください。

**また、本付属品の取扱説明書に記載されている安全上の注意事項も守ってください！**



## 01. Sicherheit

### **Bei allen Arbeiten am Streuer gilt:**

- ▶ Ausschließlich **geschultes Personal**, das mit **Sicherheitshandschuhen** ausgerüstet ist, darf die Montagearbeiten durchführen!
- ▶ Streuer komplett entleeren und **gemäß** der **Betriebsanleitung** abstellen! (Schieber geöffnet, Rückholfeder entspannt)
- ▶ Zugmaschine **ausschalten** und Zündschlüssel **abziehen!**
- ▶ Gelenkwelle, elektrische und hydraulische Anschlüsse trennen!
- ▶ Schutzgitter am Streuer **geschlossen halten!**
- ▶ Betriebsanleitung des Streuers beachten! Insbesondere das Kapitel „Sicherheit“.

### **Wenn der Streuer mit dem Schlepper, dem Hydraulikaggregat oder QUANTRON verbunden ist:**

- ▶ Ausreichend Abstand vom Dosierschieber und allen beweglichen Teilen des Streuers halten.



## 02. Bevor Sie beginnen

- 02.1. Maschine gemäß **Betriebsanleitung** abstellen und **komplett** von der Zugmaschine, den elektrischen und den hydraulischen Anschlüssen **trennen**.



### ⚠️ WARNUNG



#### Quetsch- und Schergefahr bei abgekoppeltem Wurf-Mineraldüngerstreuer

Ist beim Lösen der Festellschraube (Schieberbetätigungen K und R) die Rückholfeder gespannt, kann der Anschlaghebel ruckartig gegen das Ende des Führungsschlitzes schlagen.

Es besteht die Gefahr von Quetschungen, Abscherung und weiteren Verletzungen.

- ▶ Maschine nur mit vollständig geöffnetem Dosierschieber (Rückholfeder entspannt) abstellen.
- ▶ **Niemals** die Finger in die Führungsslitze der Streumengeneinstellung stecken.

- 02.2. Motor der Zugmaschine abstellen und Zündschlüssel abziehen.







## 02.3. Teilesatz auf Vollständigkeit prüfen.

### Legende

- a) QUANTRON-A
- b) USB-Stick
- c) Halterung
- d) 2 x Halter
- e) Führung rechts und links
- f) Aktuatoren
- g) Kabel
- h) Maschinenkabel
- i) Kabelbinder
- j) Scheiben 13 x 24 x 2,5
- k) 6 x Sicherungsscheibe
- l) Bundbolzen
- m) Scheiben 8,4 x 24 x 2,0
- n) Sechskantmuttern M10
- o) Sechskantmuttern M6
- p) Linsenflanschschrauben M5 x 10
- q) Sechskantmuttern M8
- r) Sechskantschrauben M8 x 20
- s) Scheiben 6,4 x 12,5 x 1,6
- t) Flachrundschraben M6 x 20
- u) Lagerbolzen Ø9,2 / M10
- v) Bolzen Ø30 / 12 x 37
- w) POM-Scheiben 13 x 40 x 3
- x) Flachrundschrabe M8 x 25
- y) Linsenflanschschrauben M6 x 20
- z) Scheiben 8,4 x 17 x 1,6
- aa) Rohrschelle Ø13, B20
- bb) POM-Scheiben 13,5 x 30 x 2,5 (schwarz)
- cc) Stopfen
- dd) Distanzbuchse 12,5 x 17,2 x 22
- ee) Scheiben 10,5 x 30 x 2,5

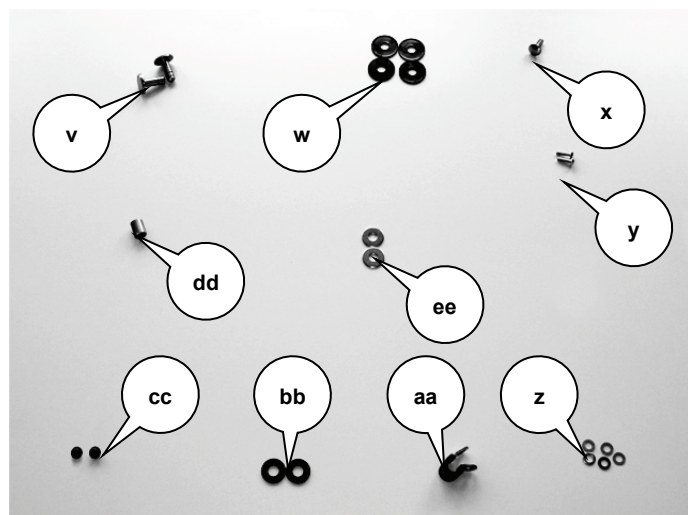
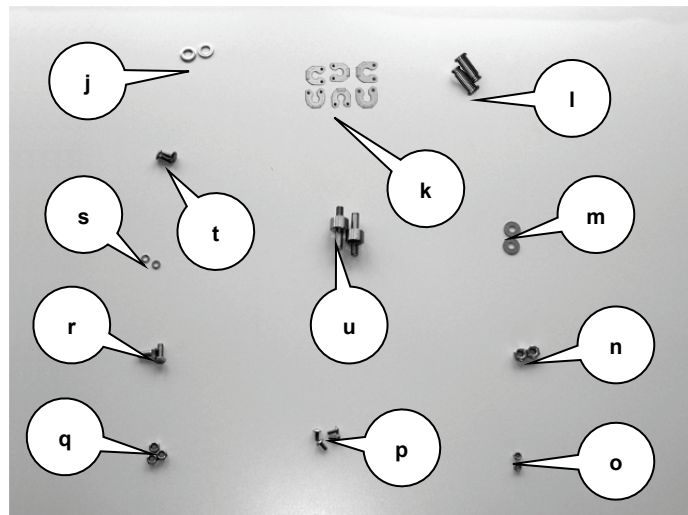
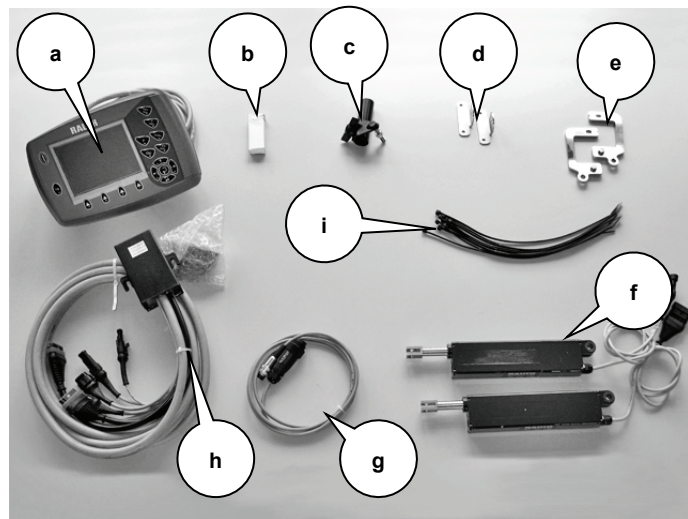



### 03. Zylinder ausbauen

#### ▲ WARNUNG



#### Verletzungsgefahr durch unter Druck austretendes Hydrauliköl

Unter Druck austretendes Hydrauliköl kann die Haut durchdringen, Sie schwer Verletzen und die Umwelt gefährden.

- ▶ Persönliche Schutzausrüstung tragen (min. Schutzhandschuhe und Schutzbrille).
- ▶ Hydraulikanlagen vor allen Wartungsarbeiten **drucklos machen**.
- ▶ Bei Verletzungen sofort einen Arzt aufsuchen! Infektionsgefahr!
- ▶ Ausgetretenes Hydrauliköl ordnungsgemäß entsorgen.

03.1. Jeweils eine geeignete Öl-Wanne unter die Zylinder stellen.





03.2. Hydraulikleitungen an den Zylindern lösen.

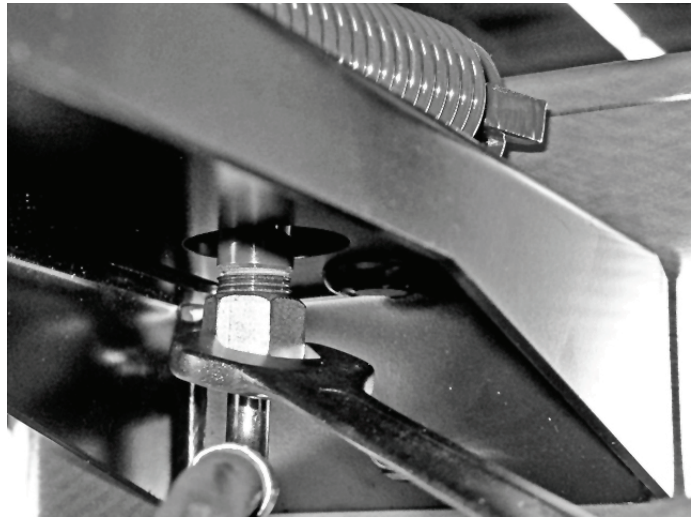

03.3. Öl in die Wannen ablassen und Hydraulikleitungen entfernen.

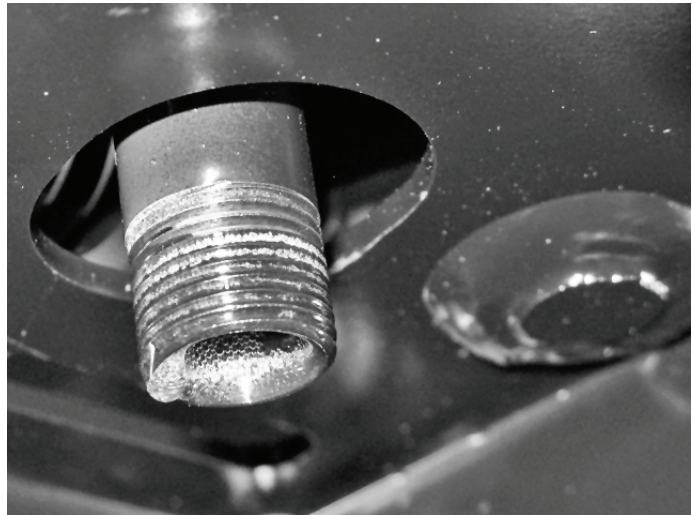

03.4. Sicherungsscheiben an den Zylindern entfernen.





- 03.5. Zylinder aus den Zapfen herausheben und auf der Mittelkonsole ablegen.

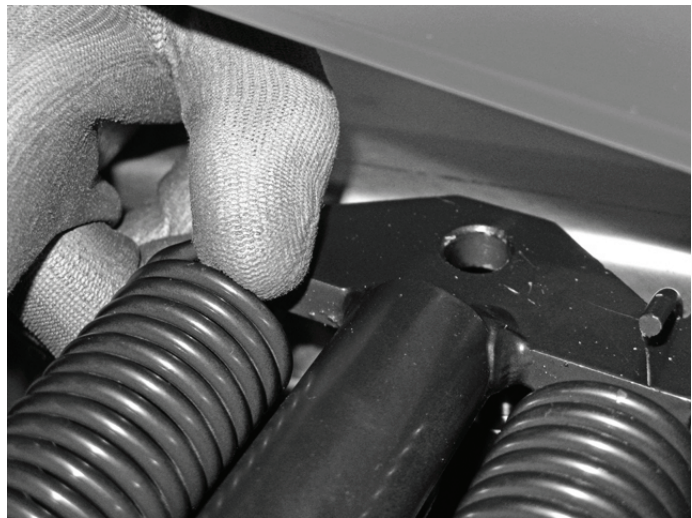

- 03.6. Die beiden Anschlaghebel auf „0“ stellen.

*Die Zylinder werden dadurch zur Maschinenmitte hin gezogen. Die Schrauben, an den Gabelköpfen der Kolbenstangen, sind jetzt zugänglich.*



- 03.7. Die Schrauben an den Gabelköpfen der Kolbenstangen lösen und herausnehmen.

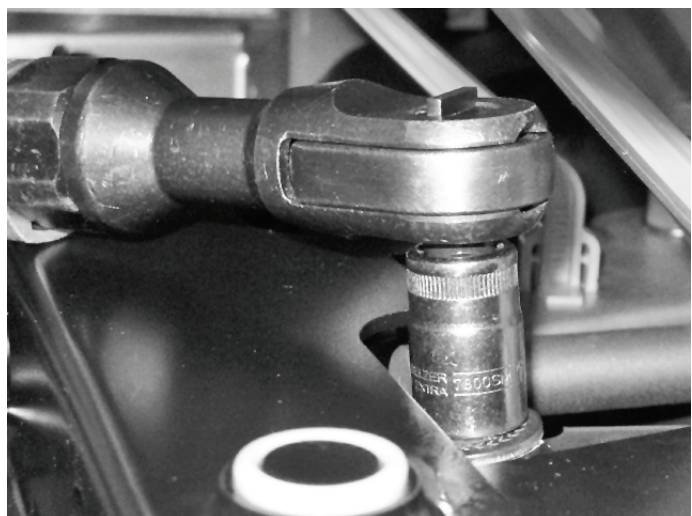



03.8. Beide Zylinder aus der Maschine herausnehmen.

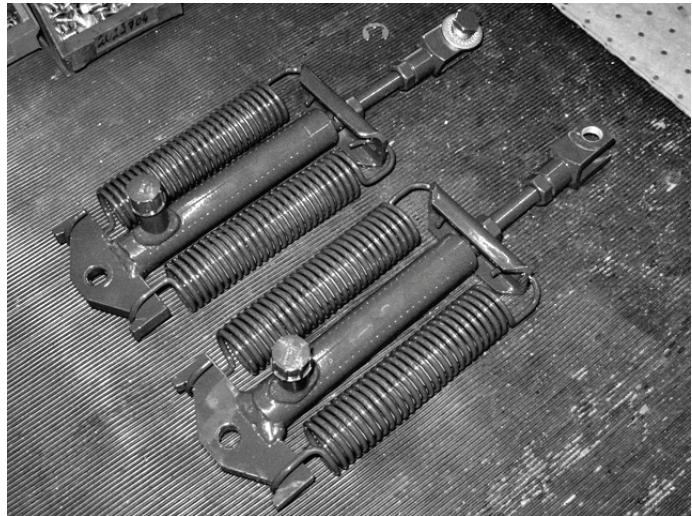

03.9. Anzeigeelemente entfernen.



03.10. Schutzgitter öffnen.





03.11. Die beiden Schrauben der Anzeige herausdrehen.



03.12. Anzeige entfernen.



03.13. Beide Löcher, von innen, mit Stopfen verschließen.

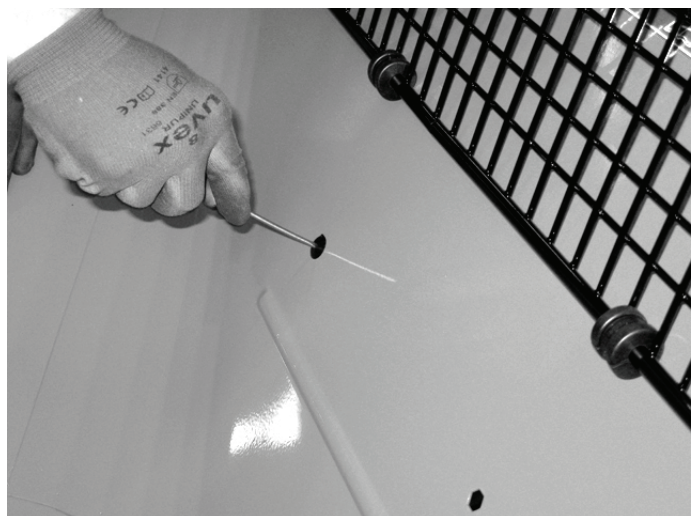



03.14. Schutzgitter schließen und  
verriegeln.





## 04. Einstellung der Skala überprüfen

*Voraussetzungen:*

*Zur Prüfung der Dosierschiebereinstellung muss die Mechanik frei beweglich sein.*

*Die Rückholfeder ist ausgehängt.*

*Der Hydraulikzylinder ist ausgehängt.*

- 04.1. Anschlaghebel auf den Wert „130“ stellen und mit dem T-Griff sichern.

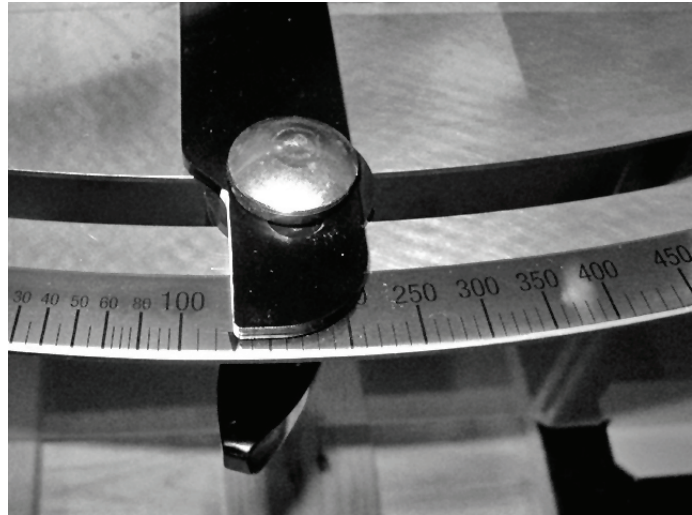

- 04.2. Dosierschieber **von Hand** an den jeweiligen Anschlag ziehen.







- 04.3. Bolzen mit  $\varnothing$  28 mm in die Öffnung stecken.  
*Dazu können Sie einen Unterlenkerbolzen des MDS verwenden.*



- 04.4. **Prüfen:** Der Bolzen muss spielfrei in die Öffnung passen.  
*Sollte das nicht der Fall sein, finden Sie weitere Informationen in der Betriebsanleitung des MDS, unter dem Kapitel „Dosierschieber überprüfen und einstellen“.*

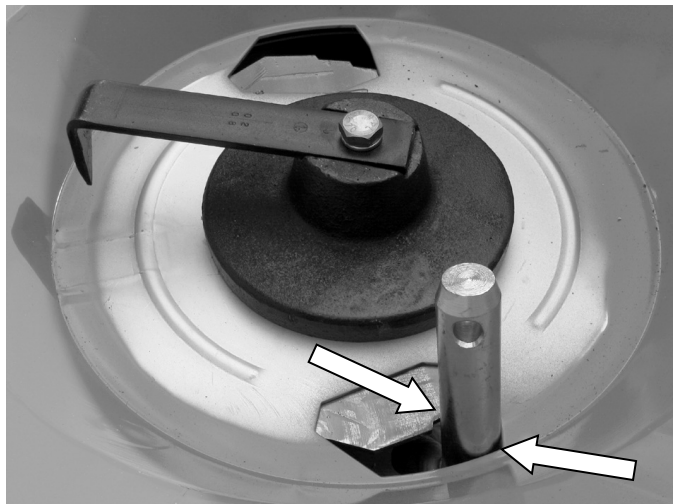

- 04.5. Bolzen heraus nehmen.

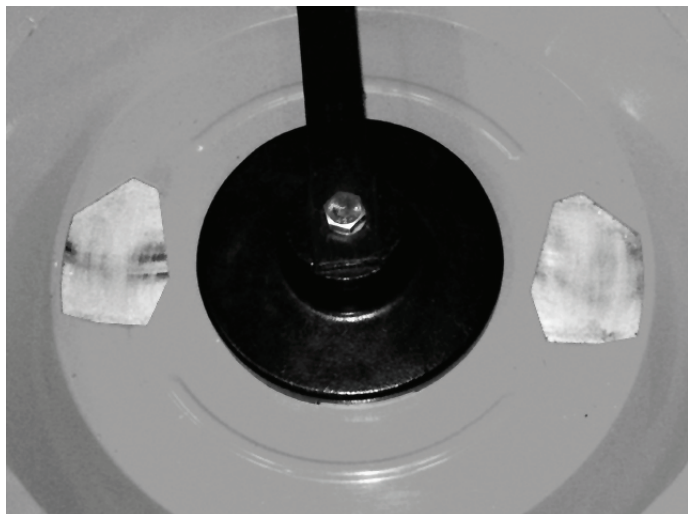



04.6. T-Griffe entfernen



04.7. Wiederholen Sie die Arbeitsschritte 1 - 6 für den rechten Dosierschieber.

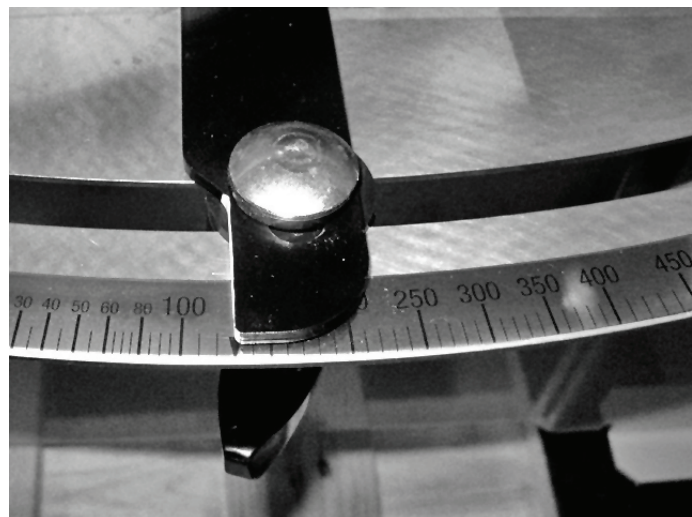

*Weitere Informationen finden Sie in der MDS-Betriebsanleitung.*



## 05. Aktuator einbauen

- 05.1. Schaltkasten von unten an die Mittelkonsole schrauben.  
Anzugsmoment:  $\approx 7 \text{ Nm}$

### Legende

- a) Scheibe 6,4 x 12,5 x 1,6
- b) Flachrundschraube oder Linsenflanschschraube M6 x 20
- c) Mutter M6

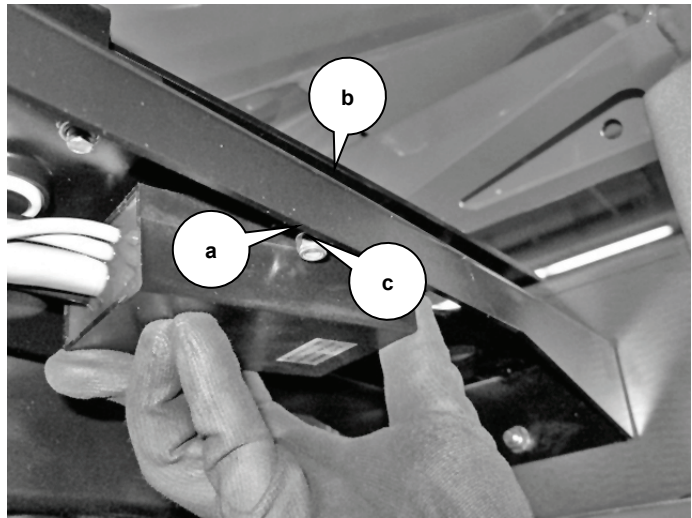

- 05.2. Die, in Fahrtrichtung, rechte Flachrundschraube aus der Konsole heraus schrauben.

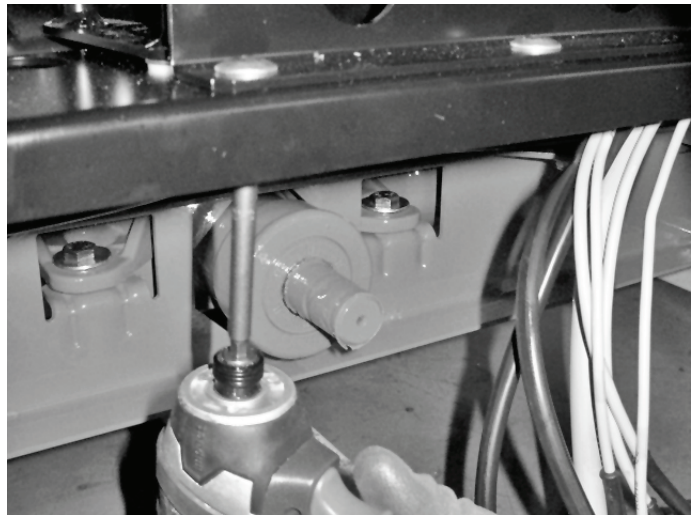

- 05.3. Rohrschelle zusammendrücken.

### Legende

- a) Rohrschelle  $\varnothing 13$ , B20
- b) Flachrundschraube M8 x 25

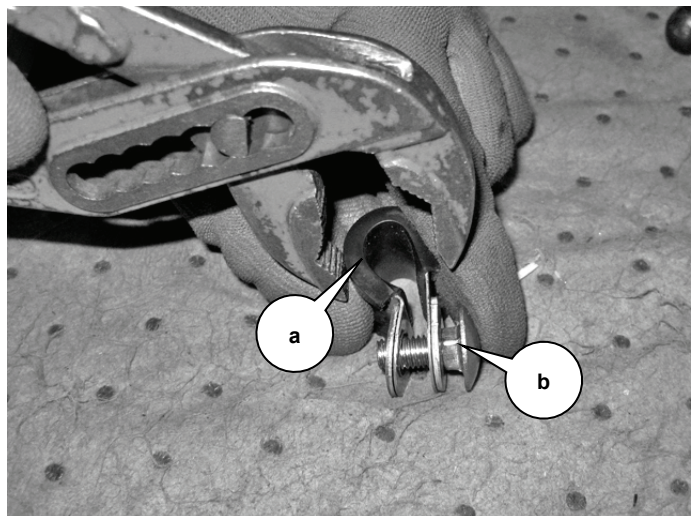



05.4. Kabel verlegen und Rohrschelle anschrauben.

Anzugsmoment: **15 Nm**

**Legende**

a) Scheibe 17 x 8,4 x 1,6

b) Mutter M8

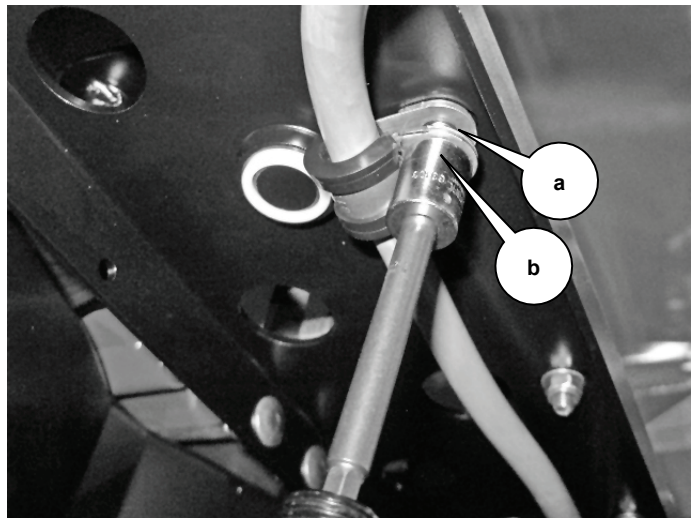

05.5. Rechten und linken Lagerbolzen in das jeweilige Langloch stecken.

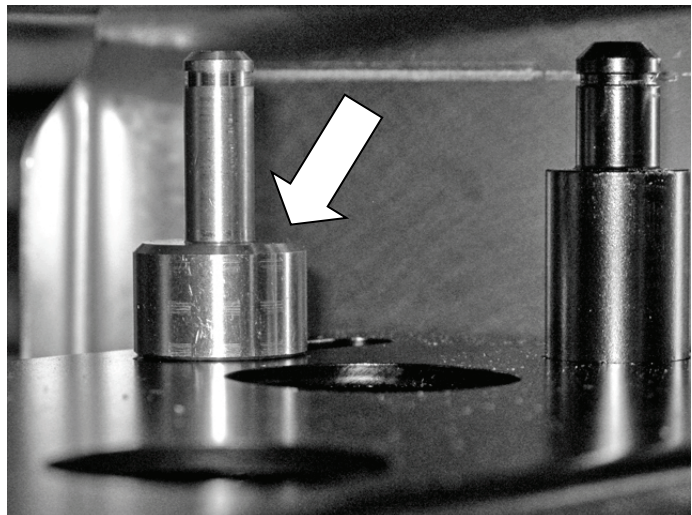

05.6. Auf der Unterseite jeweils eine Scheibe und eine Sechskantmutter per Hand anlegen.

**Legende**

a) Mutter M10

b) Scheibe 10,5 x 30 x 2,5

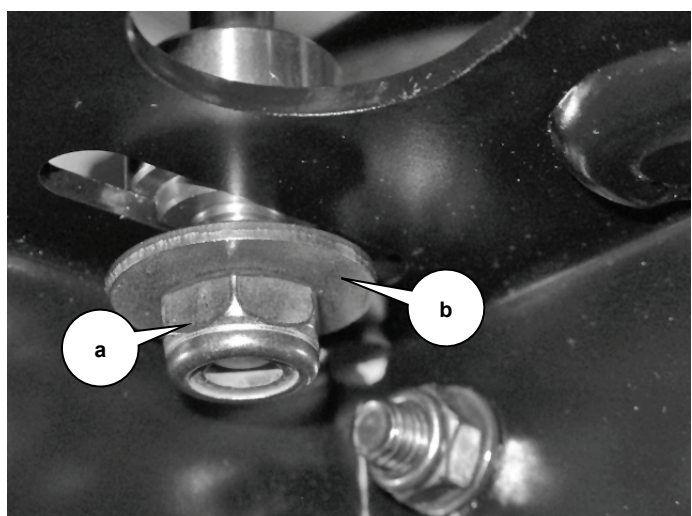



- 05.7. Kolbenstange bis zum Anschlag eindrehen.

*Drehen Sie dazu die Kolbenstange im Uhrzeigersinn.*



- 05.8. Kolbenstange wieder eine halbe Umdrehung zurückdrehen.

*Damit steht die Kolbenstange nicht mehr auf dem Endschalter des Aktuators.*

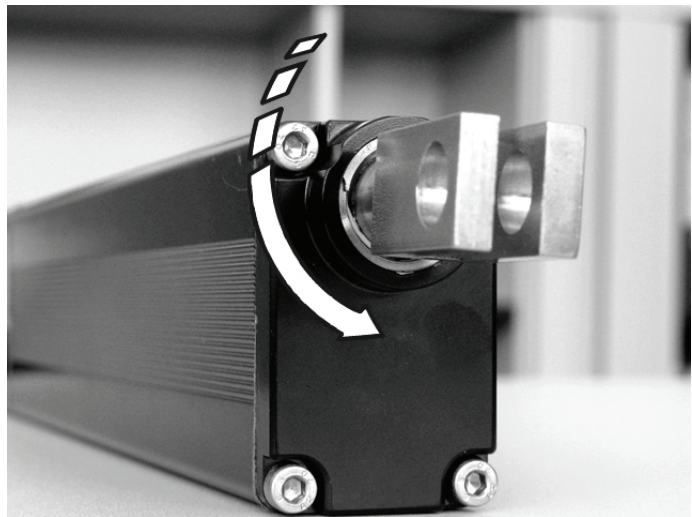

- 05.9. Auf beiden Seiten, Aktuator einsetzen und mit je einer Sicherungsscheibe sichern.  
*Kabel nach unten führen.*

**Legende**

a) Aktuator

b) Sicherungsscheibe

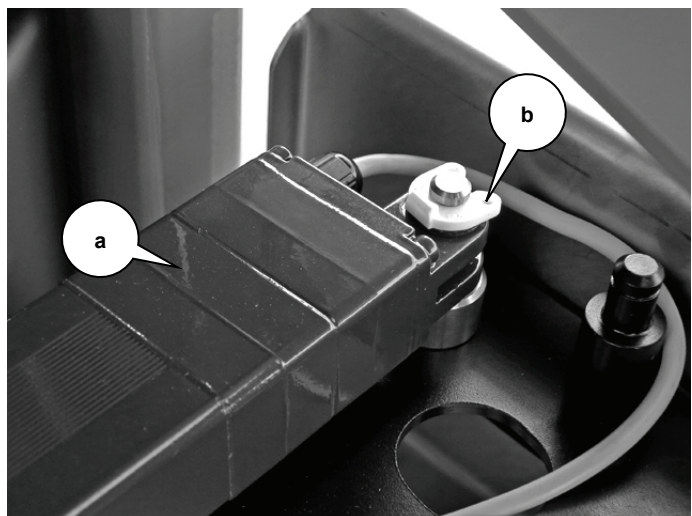



05.10. Beide Aktuatoren nach innen an den Anschlag schieben.

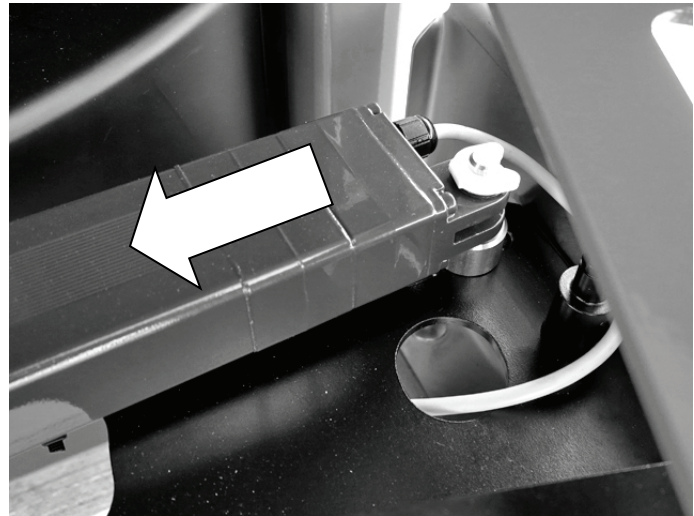



## 06. Kabel verlegen/Aktuatoren anschließen

06.1. Kabel auf der Unterseite der Konsole mit einem Kabelbinder sichern.



06.2. Aktuatoren **entsprechend** der **Markierung** mit dem Schaltkasten verbinden.





- 06.3. Kabel des Aktuators, in **ausreichendem Abstand** vom Stecker, mit Kabelbindern sichern.



- 06.4. Alle nicht benötigten Stecker mit Kabelbindern zusammenbinden.







## 07. Aktuatoren und Schieber verbinden

### 07.1. Bundbolzen überprüfen.

*Die Bundbolzen müssen in die Führung passen.*



### 07.2. Nur wenn ein Bolzen nicht passt:

Bohrung im Führungsteil entgraten.

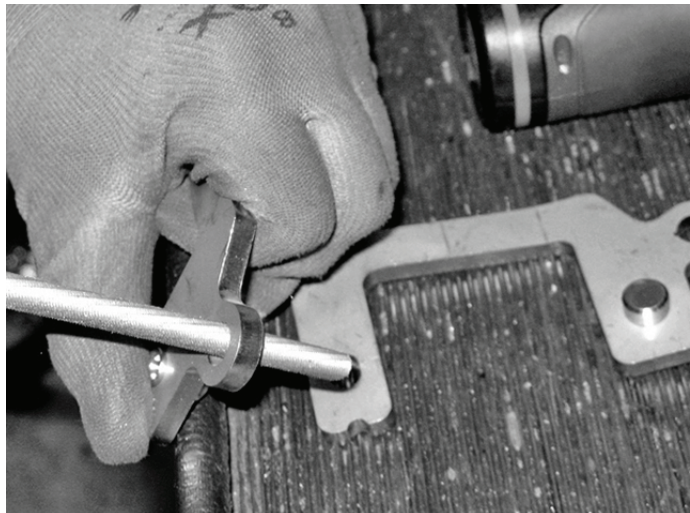

### 07.3. Beide Dosierschieber in die Mittelstellung stellen.

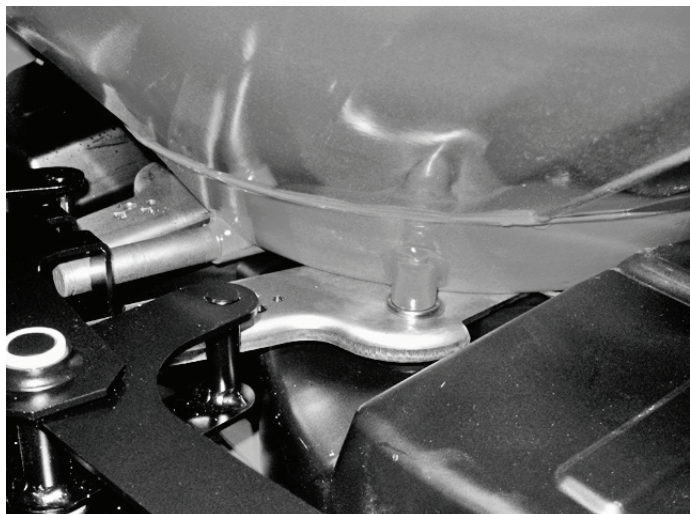



- 07.4. Anschlaghebel an den jeweiligen Dosierschieber **anlegen**.  
*Zwischen den beiden Bauteilen darf es **kein Spiel** geben.*



- 07.5. Führung mit dem Schieber verbinden.  
*Zwischen der Führung, dem Anschlaghebel und dem Dosierschieber darf es **kein Spiel** geben.*



- 07.6. Beide Führungen mit den Dosierschiebern verschrauben.  
Anzugsmoment: **15 Nm**

**Legende**

- a) Sechskantschraube M8 x 25
- b) Scheibe 17 x 8,4 x 1,6
- c) Sechskantmutter M8

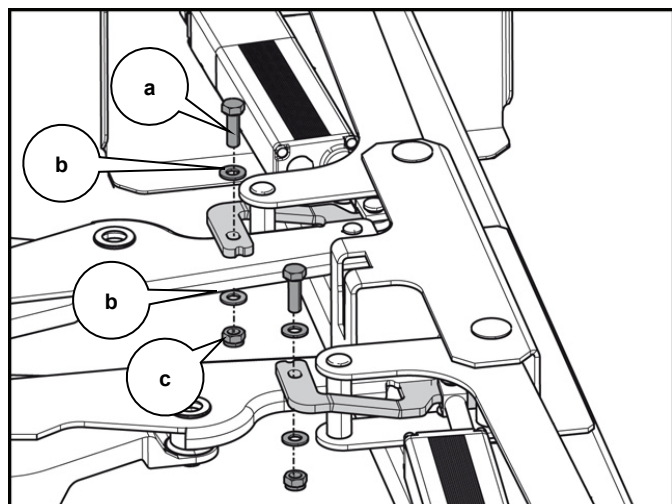



07.7. Führung fetten.



07.8. Aktuatoren mit den Führungen verbinden.

**Legende**

a) Bundbolzen

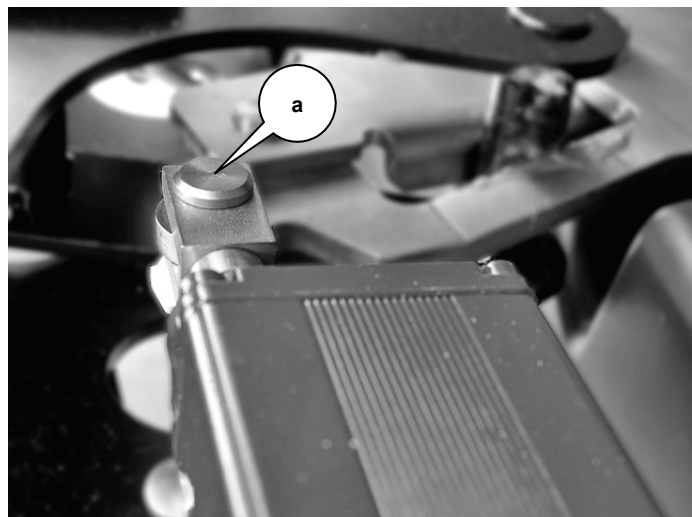

07.9. Beide Verbindungsbolzen sichern.  
Abstand zwischen der Unterkante des Bundbolzens und des Anschlaghebels min. 4 mm.  
*Andernfalls könnte sich der Bundbolzen mit dem Anschlaghebel verkanten.*

**Legende**

a) Bundbolzen

b) Sicherungsscheibe

c) Anschlaghebel

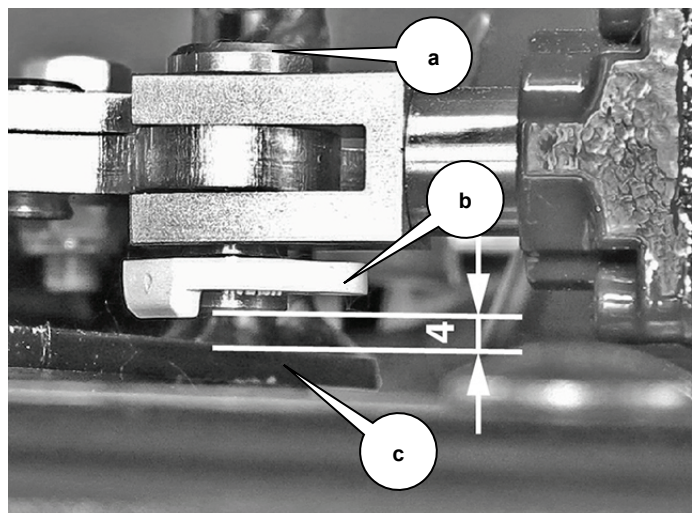



07.10. Bolzen an der Skala einstecken.

**Legende**

- a) Bolzen
- b) POM-Scheibe 13 x 40 x 3
- c) POM-Scheibe 13,5 x 30 x 2,5

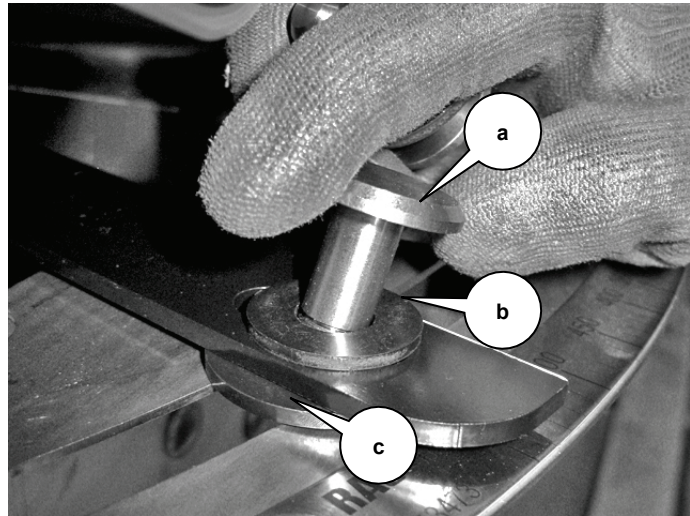

07.11. Bundbolzen sichern.

**Legende**

- a) POM-Scheibe 13,5 x 30 x 2,5
- b) POM-Scheibe 13 x 40 x 3
- c) Scheibe 13 x 24 x 2,5
- d) Sicherungsscheibe

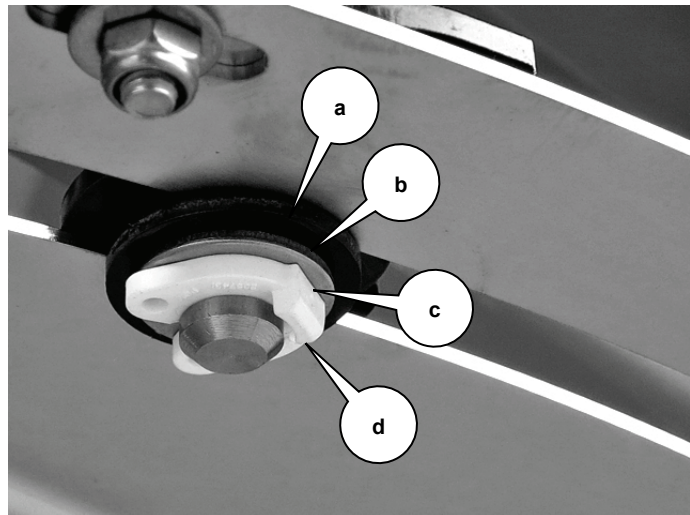

07.12. Aktuatoren nach außen schieben, bis der Anschlaghebel ca. einen halben Strich über 500 (Pfeil) steht.

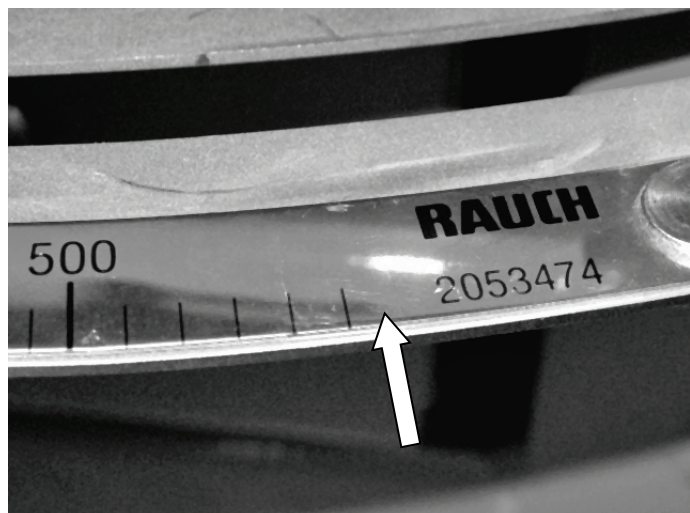



07.13. Die Mutter am Lagerbolzen  
festziehen.

Anzugsmoment:  $\approx 30$  Nm





## 08. QUANTRON-A

08.1. Eines der Haltebleche für die QUANTRON-A fest anschrauben.

### Legende

- a) Linsenflanschschraube  
M5 x 10

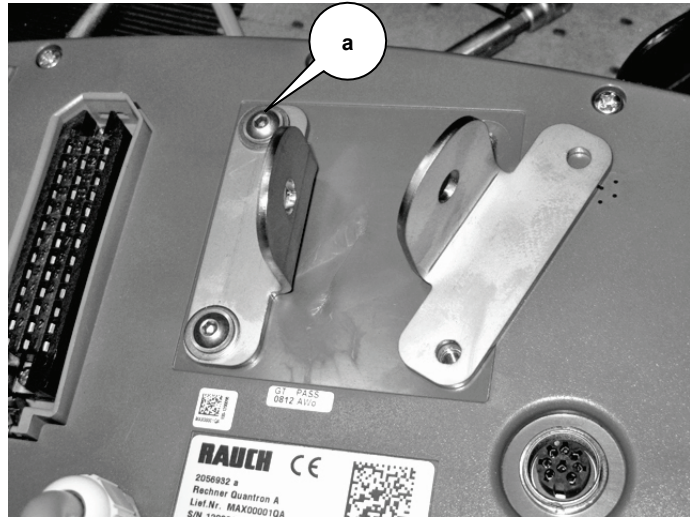

08.2. Halterung mit einer Schraube an das Halteblech stecken.

### Legende

- a) Scheibe 8,4 x 24 x 2

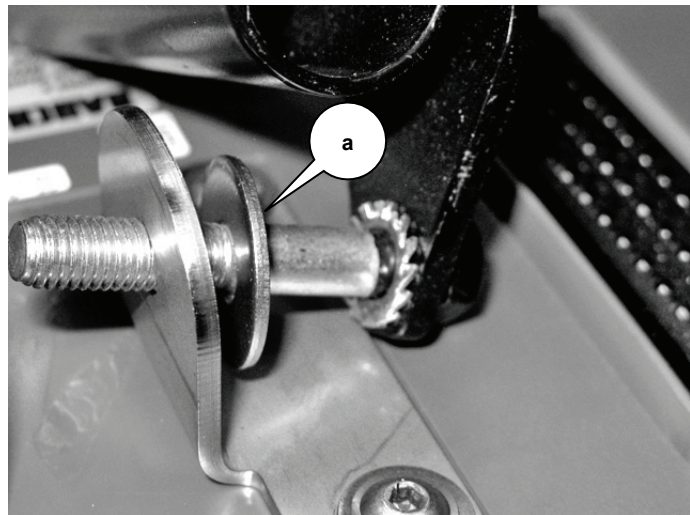

08.3. Distanzbuchse und zweites Halteblech ansetzen und lose montieren.

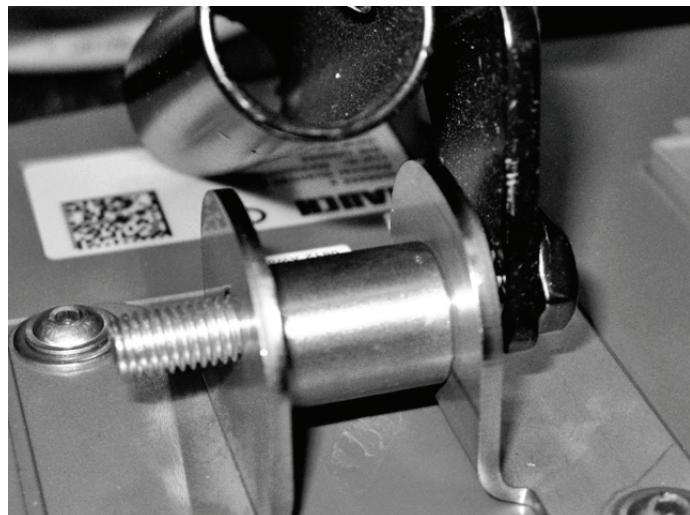



08.4. Mutter anlegen und festziehen.

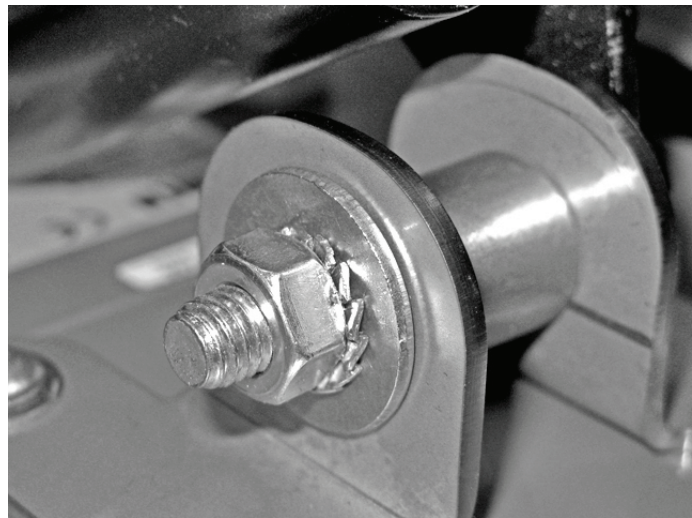

08.5. Linsenflanschsrauben am zweiten Halblech festziehen.

**Legende**

- a) Linsenflanschschraube  
M5 x 10

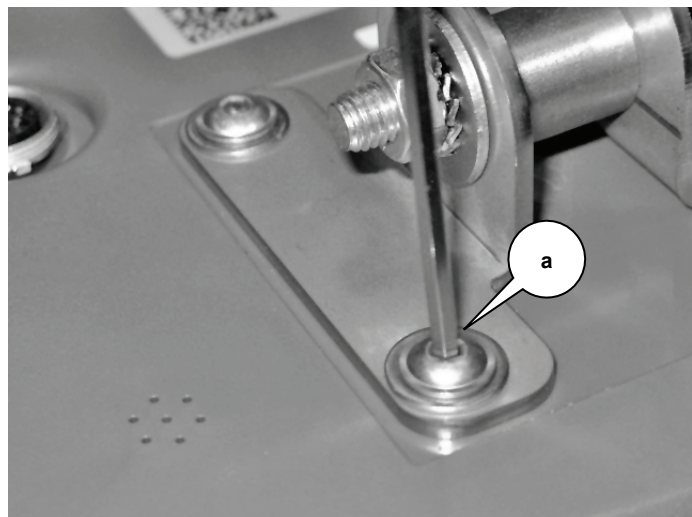



## 09. QUANTRON-A kalibrieren

### ⚠ GEFAHR!



#### **Dosierschieber ist fremdbetätigt**

Scher- und Quetschgefahr, Sie verlieren Gliedmaßen!

- ▶ Schutzgitter geschlossen halten.
- ▶ Ausreichend Abstand zu allen beweglichen Teilen des Streuers halten.
- ▶ Betriebsanleitung des Streuers beachten, insbesondere das Kapitel „Sicherheit“!

### 09.1. QUANTRON-A mit dem Streuer verbinden.

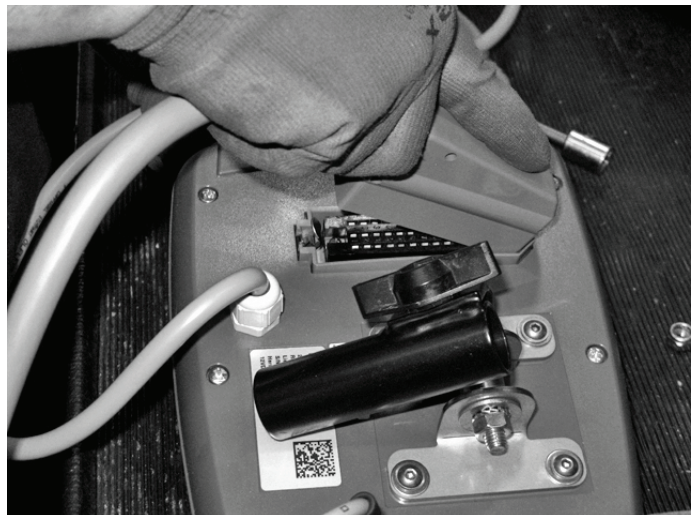

### 09.2. QUANTRON-A an die Spannungsversorgung anschließen.

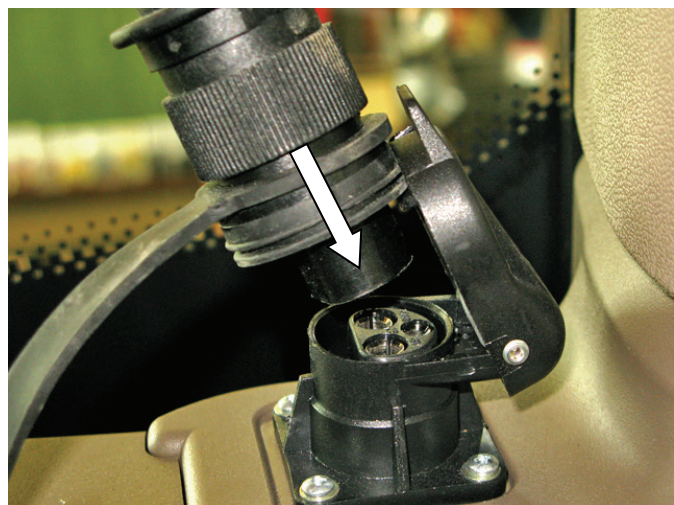





09.3. QUANTRON-A einschalten.



09.4. Taste **Menu** drücken.

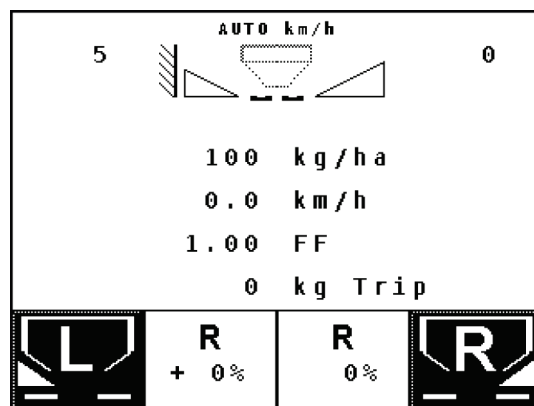

09.5. **System / Test > Service** jeweils auswählen und mit **ENTER** bestätigen.

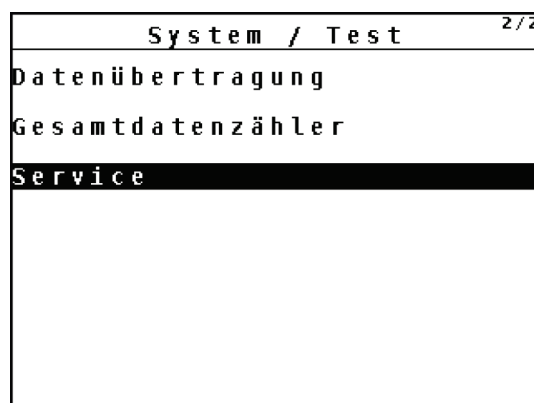



09.6. Code **3354** mit den **Pfeiltasten** eingeben und mit **ENTER** bestätigen.

Freigabecode
<b>3354</b>

09.7. **Maschinenoptionen > Skala max** jeweils auswählen und mit **ENTER** bestätigen.

Maschinenoptionen	1/3
Leermelder	✓
Telimitsensoren	✓
Aktuator	RH03
<b>Skala max</b>	<b>410</b>
Wiegezellen	
MHC	
AGP	

09.8. **ENTER** mehrfach drücken und den Maximalwert „**550**“ auswählen.

Maschinenoptionen	1/3
Leermelder	✓
Telimitsensoren	✓
Aktuator	RH03
<b>Skala max</b>	<b>550</b>
Wiegezellen	
MHC	
AGP	



09.9. **Service** aufrufen, dazu mehrfach **ESC** drücken.



09.10. **Schieber kalibrieren** auswählen und **ENTER** drücken.

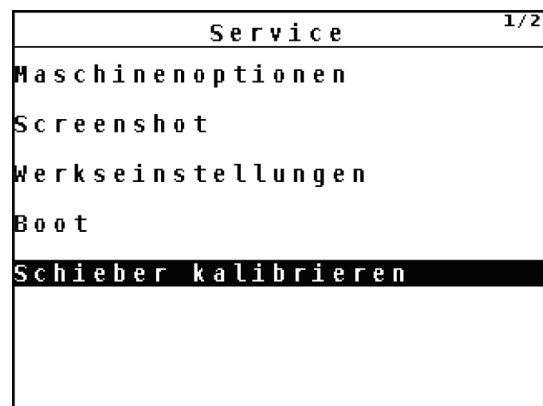

09.11. **Rechten Schieber** mit den **Funktionstasten** auf den unteren Anschlag fahren.

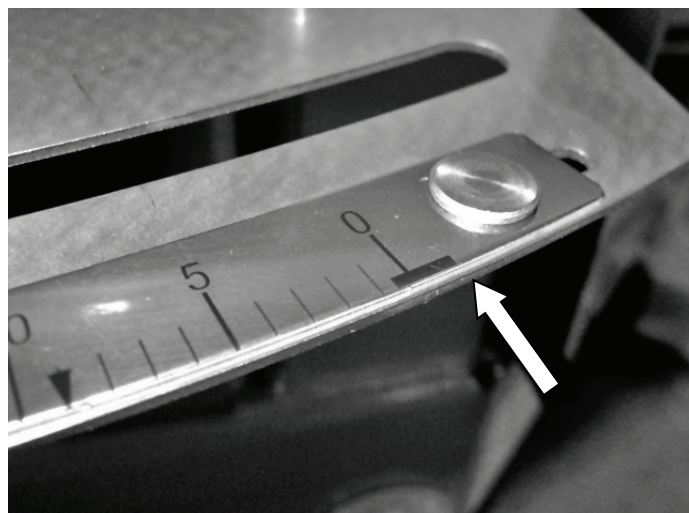



09.12. **Rechten Schieber** mit den **Funktionstasten** auf den Wert „0“ stellen und **ENTER** drücken.

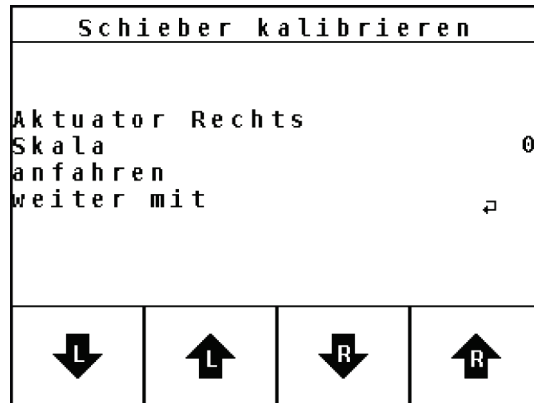

09.13. **Rechten Schieber** mit den **Funktionstasten** auf **130** stellen und **ENTER** drücken.



09.14. **Rechten Schieber** mit den **Funktionstasten** auf **550** stellen und **ENTER** drücken.





09.15. **Rechten Schieber** mit den **Funktionstasten** auf einen Wert zwischen „0“ und dem unteren Anschlag stellen.

Schieber kalibrieren	
Aktuator Rechts	
Skala	- 1
anfahren	
weiter mit	2

↓      ↑      ↓      ↑

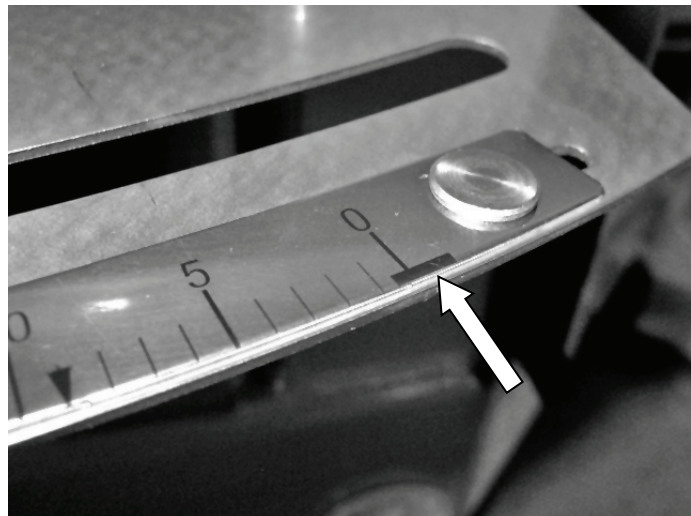

09.16. **Auf Sicht** prüfen: Der rechte Schieber muss jetzt komplett geschlossen sein.  
*Sollte der Schieber noch geöffnet sein, finden Sie weitere Information im Kapitel 10 „Wenn beim Kalibrieren ein Schieber teilweise offen war“*

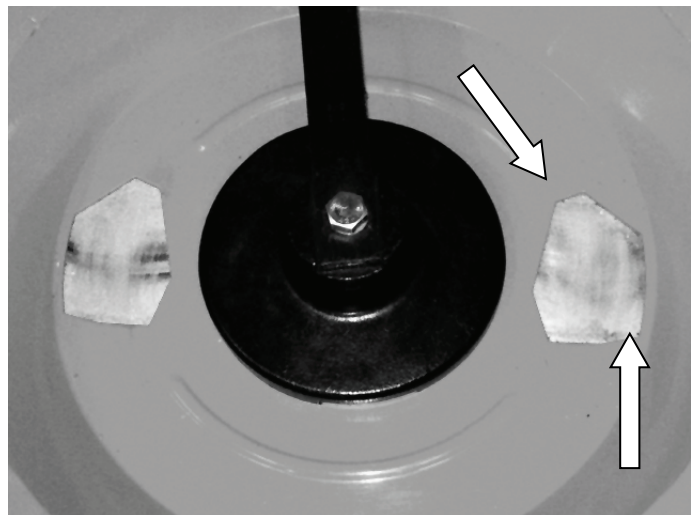



09.17. **ENTER** drücken.



09.18. **Linken Schieber** mit den **Funktionstasten** auf den Wert „0“ stellen und **ENTER** drücken.

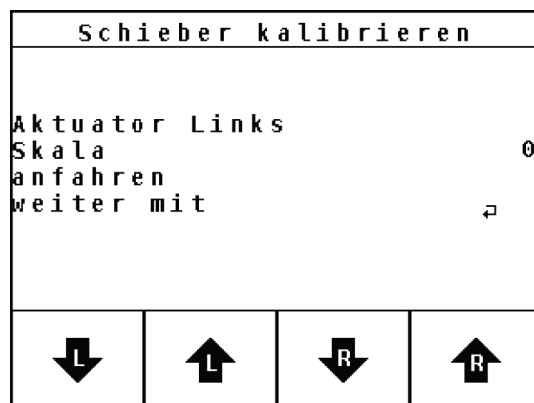

09.19. **Linken Schieber** mit den **Funktionstasten** auf **130** stellen und **ENTER** drücken.





09.20. **Linken Schieber** mit den **Funktionstasten** auf **550** stellen und **ENTER** drücken.

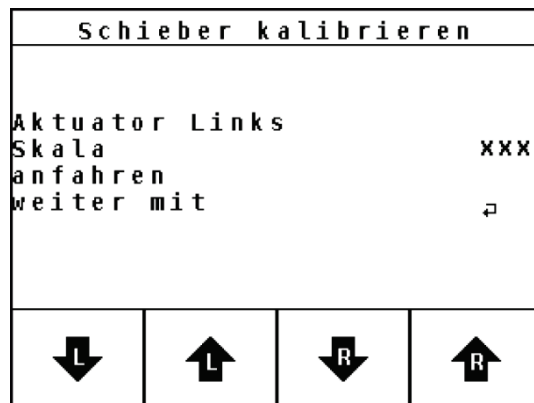

09.21. **Linken Schieber** mit den **Funktionstasten** auf einen Wert zwischen „0“ und dem unteren Anschlag stellen.

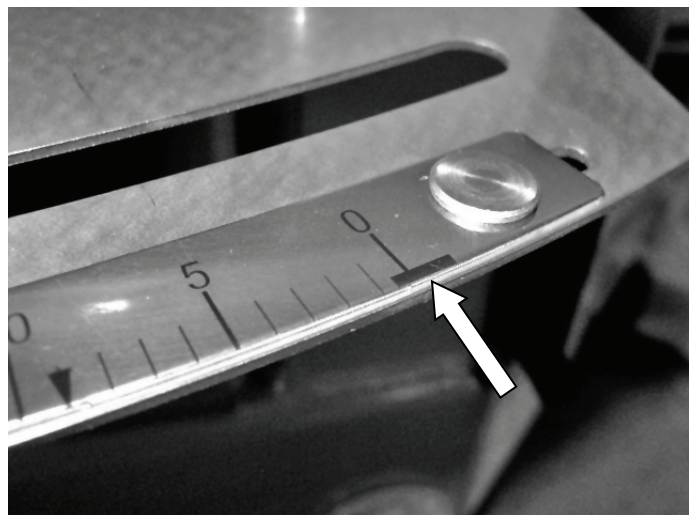
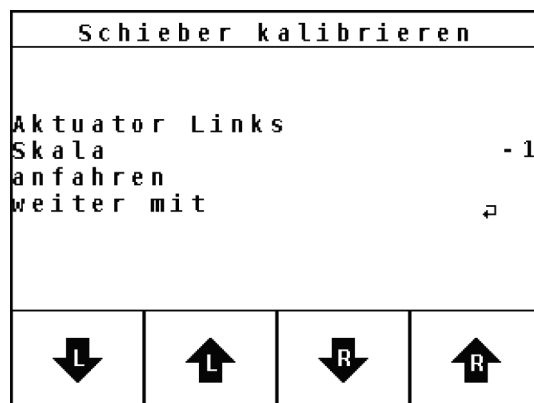



09.22. **Auf Sicht** prüfen: Der linke Schieber muss jetzt komplett geschlossen sein.  
*Sollte der Schieber noch geöffnet sein, finden Sie weitere Information im Kapitel 10 „Wenn beim Kalibrieren ein Schieber teilweise offen war“*

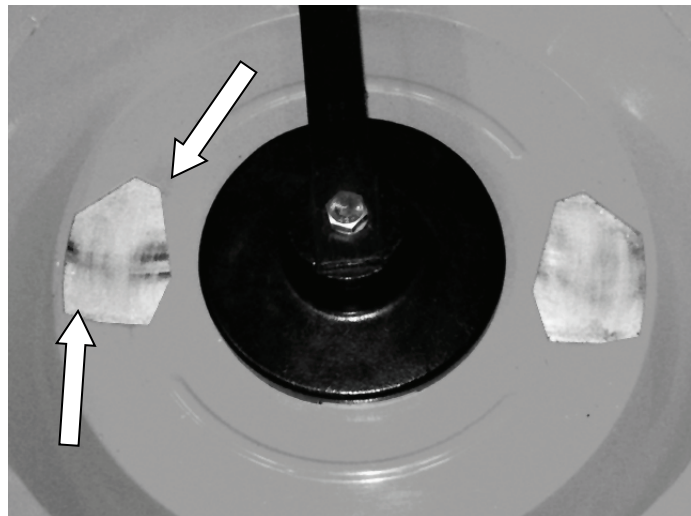

09.23. **ENTER** drücken.

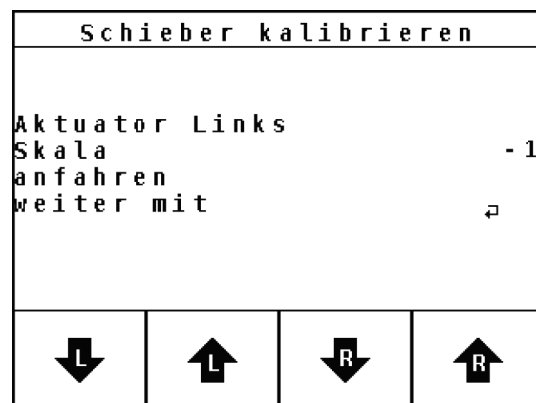

09.24. Betriebsbild aufrufen, dazu mehrfach **ESC** drücken.







## 10. Wenn beim Kalibrieren ein Schieber teilweise offen war

### ▲ GEFAHR!



#### **Dosierschieber ist fremdbetätigt**

Scher- und Quetschgefahr, Sie verlieren Gliedmaßen!

- ▶ Motor der Zugmaschine bzw. Hydraulikaggregat abstellen.
- ▶ Zündschlüssel abziehen.
- ▶ QUANTRON-A ausschalten und vom Streuer trennen
- ▶ Streuer gemäß Betriebsanleitung abstellen.
- ▶ Streuer komplett von der Zugmaschine bzw. dem Hydraulikaggregat trennen.
- ▶ Betriebsanleitung des Streuers beachten, insbesondere das Kapitel „Sicherheit“!

### 10.1. Mutter am Lagerbolzen lösen.





10.2. Zylinder verschieben.

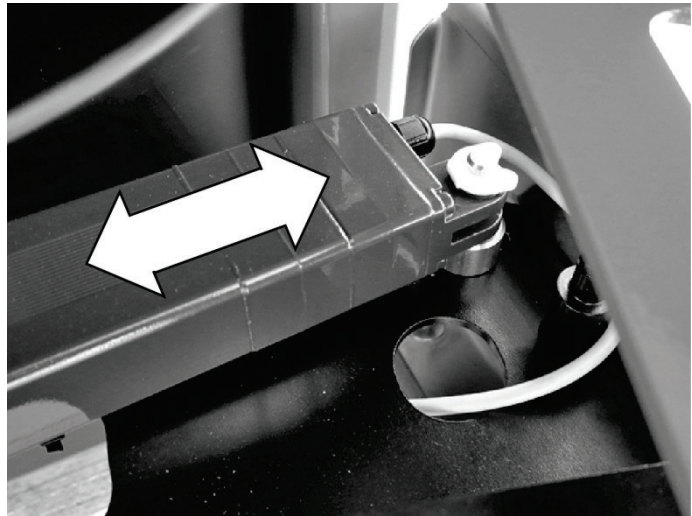

10.3. Die Mutter am Lagerbolzen festziehen.  
Anzugsmoment:  $\approx 30$  Nm



10.4. Kalibrierung wiederholen  
(siehe Kapitel 09)





## 11. Kalibrierung kontrollieren

**⚠ GEFAHR!**



### **Dosierschieber ist fremdbetätigt**

Scher- und Quetschgefahr, Sie verlieren Gliedmaßen!

- ▶ Schutzgitter **geschlossen** halten.
- ▶ **Ausreichend Abstand** zu allen beweglichen Teilen des Streuers **halten**.
- ▶ Betriebsanleitung des Streuers beachten, insbesondere das Kapitel „Sicherheit“!

11.1. QUANTRON-A mit dem Streuer verbinden.

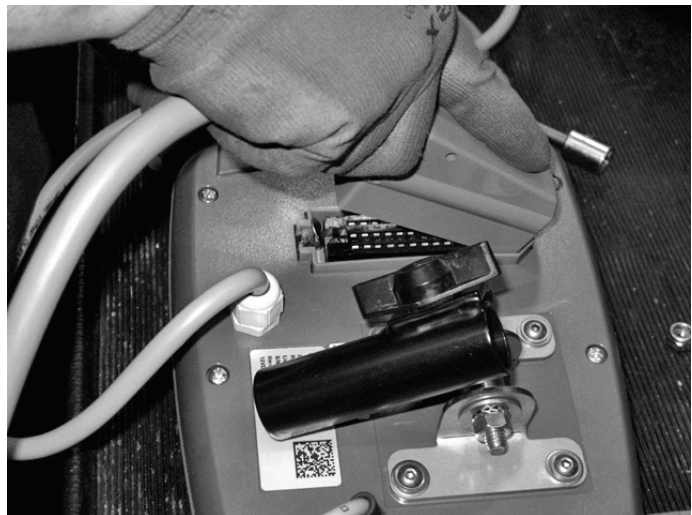

11.2. QUANTRON-A an die Spannungsversorgung anschließen.

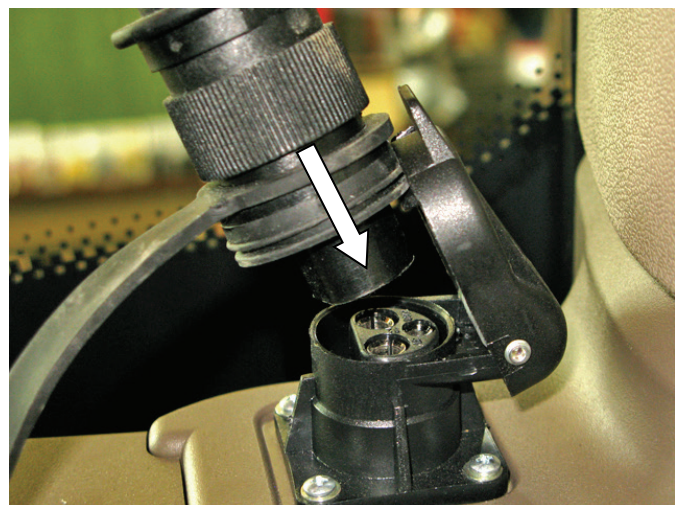



11.3. Taste **Menu** drücken.

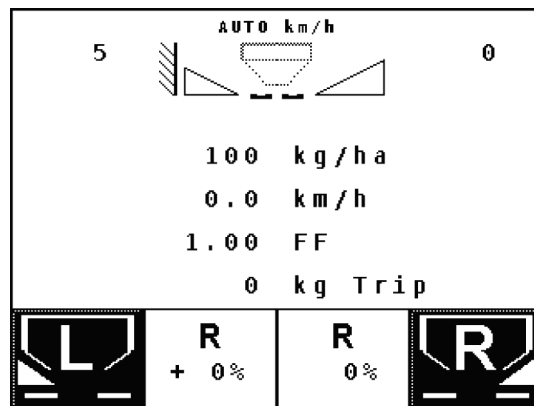

11.4. **System / Test >**  
**Test / Diagnose >**  
**Testpunkte Schieber**  
jeweils auswählen und mit  
**ENTER** bestätigen.

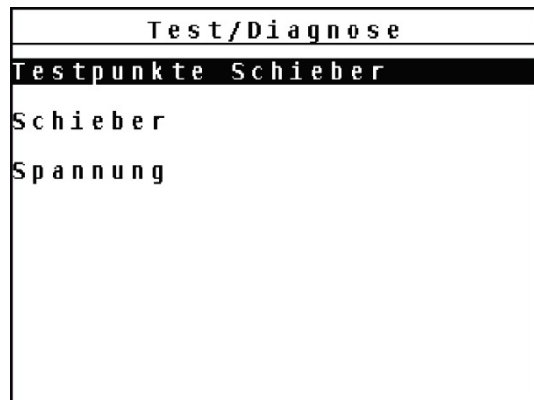

11.5. Testpunkte anfahren, auf beiden  
Seiten kontrollieren und jeweils  
bestätigen.





- 11.6. Betriebsbild aufrufen, dazu mehrfach **ESC** drücken.





## 12. QUANTRON-A einstellen

### ⚠ GEFAHR!



#### Dosierschieber ist fremdbetätigt

Scher- und Quetschgefahr, Sie verlieren Gliedmaßen!

- ▶ Schutzgitter **geschlossen** halten.
- ▶ **Ausreichend Abstand** zu allen beweglichen Teilen des Streuers **halten**.
- ▶ Betriebsanleitung des Streuers beachten, insbesondere das Kapitel „Sicherheit“!

Die Einstellungen in diesem Kapitel sind nur möglich, wenn Sie QUANTRON-A auf den Modus „Expert“ gestellt haben.

Weitere Informationen finden Sie in der QUANTRON-A-Betriebsanleitung.

### 12.1. Menu drücken.

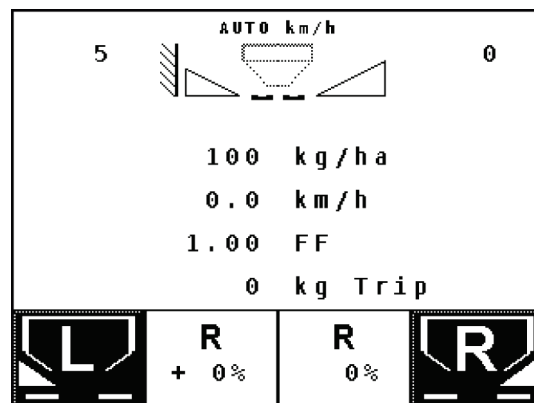

### 12.2. Düngereinstellungen > Wurfscheibentyp

jeweils auswählen und ENTER drücken.

Dünger Einstellungen <sup>2/3</sup>	
<b>Wurfscheibentyp</b>	
Zapfwelle	540
Grenzstreuart	Grenze
Telimat Grenze	-----
Düngungsart	Normal
Anbauhöhe	50/50



12.3. Eingebauten Wurfscheibentyp auswählen und **ENTER** drücken.

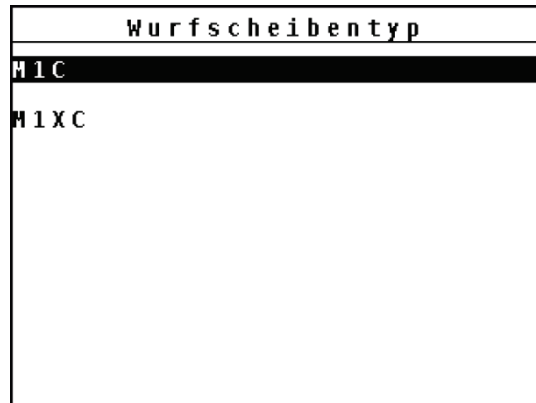

12.4. Betriebsbild aufrufen, dazu mehrfach **ESC** drücken.



12.5. **Menu** drücken.

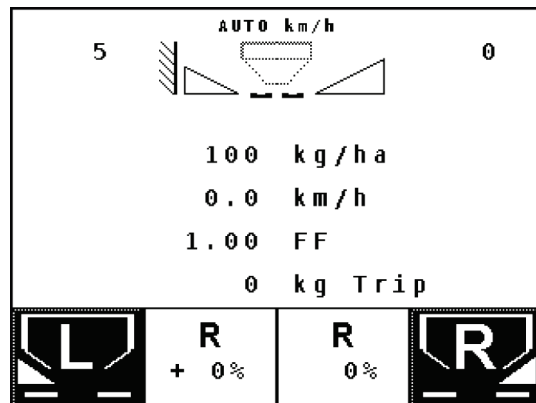



12.6. **Schnellentleerung** auswählen und **ENTER** drücken.

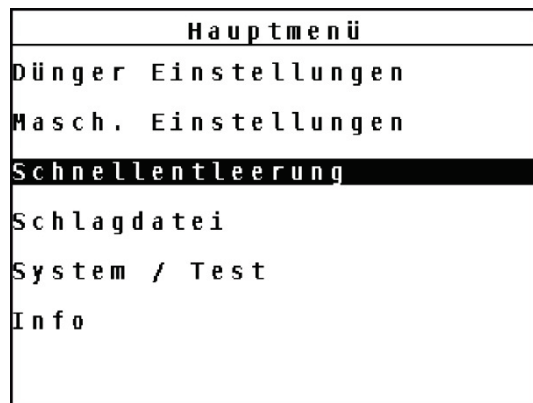

12.7. Mit den Funktionstasten, beide Seiten auswählen.

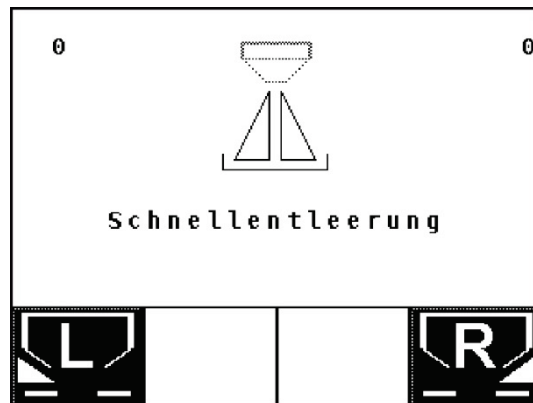

12.8. **Start** drücken.







12.9. QUANTRON-A ausschalten.



12.10. **QUANTRON-A** von der Spannungsversorgung und vom Streuer trennen.

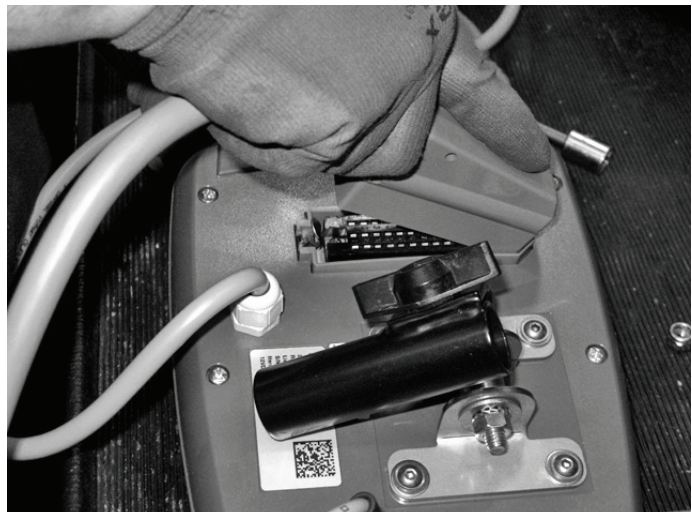



## VORSICHT

### Beschädigungen durch Wasser und Schmutz

Wasser und Schmutz beschädigen den Stecker

- ▶ Die Öffnung des Steckers muss nach unten zeigen.

12.11. Maschinenkabel verstauen.

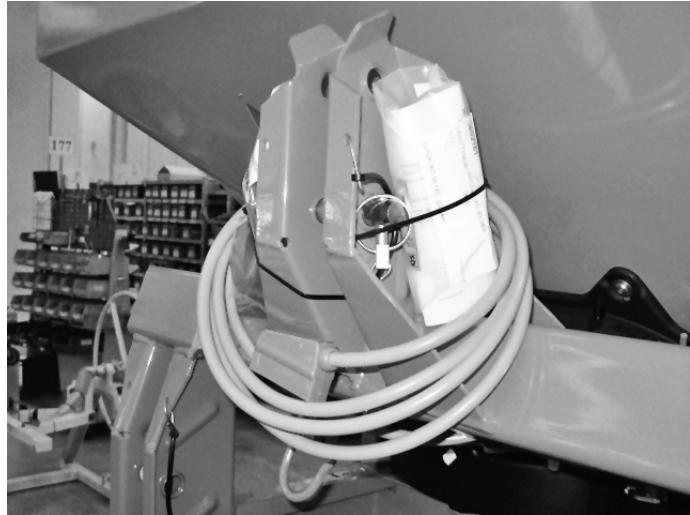



Umrüstsatz MDS





Conversion kit MDS





## 01. Safety

**The following applies to any work carried out on the spreader:**

- ▶ Only **trained personnel** equipped with **safety gloves** may carry out the assembly work!
- ▶ Completely empty the spreader and park it **according to** the instructions in the **operating manual!** (slider open, return spring released)
- ▶ Switch the tractor **off** and **remove** the ignition key!
- ▶ Disconnect the universal drive shaft and the electrical and hydraulic connections!
- ▶ Keep the protective grid on the spreader **closed!**
- ▶ Observe the operating manual of the spreader! Especially the chapter "Safety".

**If the spreader is connected to the tractor, the hydraulic unit or the QUANTRON unit:**

- ▶ Keep sufficient distance to the metering slide and all moving parts of the spreader.



## 02. Before you begin

- 02.1. Park the machine **according to the operating manual** and **disconnect it completely** from the tractor and the electrical and hydraulic connections.



### ⚠ WARNING



#### **Risk of crushing and shearing due to uncoupled mineral fertiliser spreader**

If the return spring is tensioned when the set screw is loosened (slide actuators K and R), the stop lever may hit the end of the guide slot.

There is a risk of crushing, shearing and other injuries.

- ▶ Always park the machine with the metering slide completely open (return spring is released).
- ▶ **Never** put your fingers in the guide slots of the application rate setting device.

- 02.2. Switch off the engine of the tractor and remove the ignition key.





02.3. Check the parts set for completeness.

**Legend**

- a) QUANTRON-A
- b) USB stick
- c) Retainer
- d) 2 x retaining plates
- e) Right and left guide
- f) Actuators
- g) Cable
- h) Machine cable
- i) Cable tie
- j) Washers 13 x 24 x 2.5
- k) 6 x locking washers
- l) Flange bolt
- m) Washers 8.4 x 24 x 2.0
- n) M10 hexagonal nuts
- o) M6 hexagonal nuts
- p) M5 x 10 lens head screws
- q) M8 hexagonal nuts
- r) M8 x 20 hex cap screws
- s) Washers 6.4 x 12.5 x 1.6
- t) M6 x 20 round-head screws
- u) Bearing pin Ø9.2 / M10
- v) Pin Ø30 / 12 x 37
- w) POM washers 13 x 40 x 3
- x) M8 x 25 round-head screw
- y) M6 x 20 lens head screws
- z) Washers 8.4 x 17 x 1.6
- aa) Pipe clamp Ø13, B20
- bb) POM washers 13.5 x 30 x 2.5 (black)
- cc) Plug
- dd) Spacer sleeve 12.5 x 17.2 x 22
- ee) Washers 10.5 x 30 x 2.5

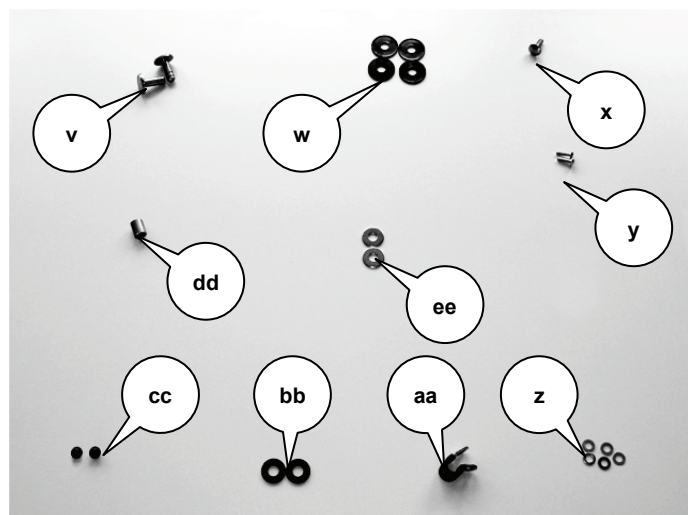
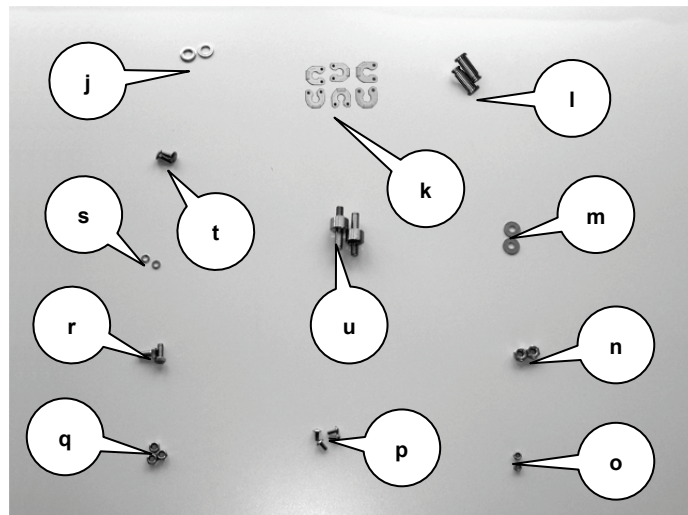
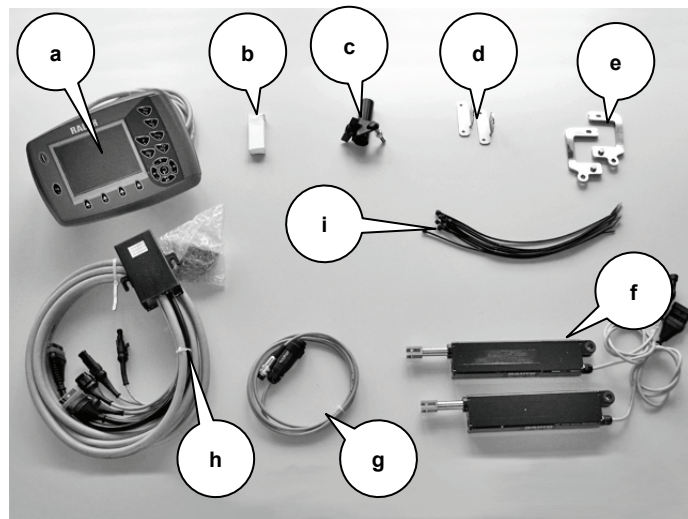



### 03. Removing the cylinder

#### **⚠ WARNING**



**Risk of injury due to hydraulic fluid leaking under pressure.**

Hydraulic fluid leaking under pressure may penetrate the skin and cause severe injuries and environmental damage.

- ▶ Wear personal protective equipment (protective gloves and goggles at the least).
- ▶ Always **depressurise** hydraulic systems before starting any maintenance work.
- ▶ In case of an injury, seek medical attention immediately!  
Danger of infection!
- ▶ Correctly dispose of any leaked hydraulic fluid.

- 03.1. Place a suitable oil pan underneath the cylinders.







03.2. Loosen the hydraulic hoses at the cylinders.

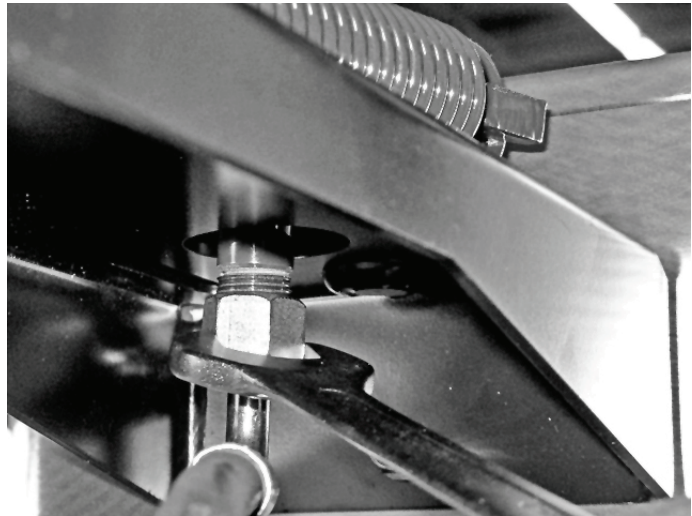

03.3. Let the oil drain into the pans and remove the hydraulic hoses.

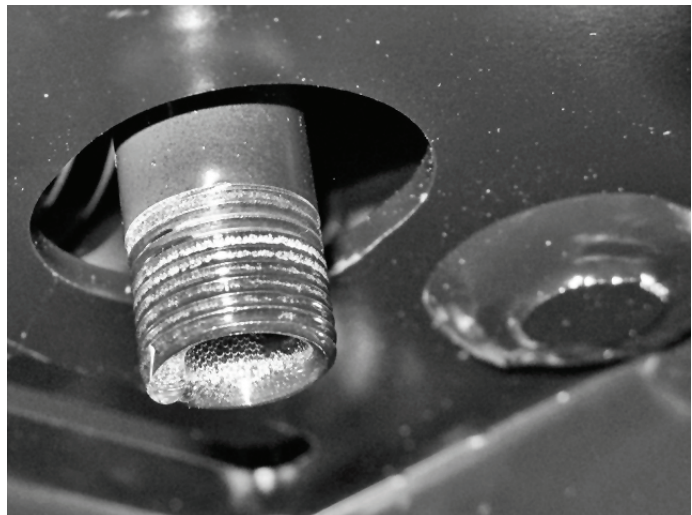

03.4. Remove the locking washers from the cylinders.





- 03.5. Lift the cylinder out of the pins and place it on the central panel.



- 03.6. Set both stop levers to "0".  
*This way, the cylinders will be pulled towards the centre of the machine. The screws located at the fork heads of the piston rods are now accessible.*



- 03.7. Loosen and remove the screws at the fork heads of the piston rods.

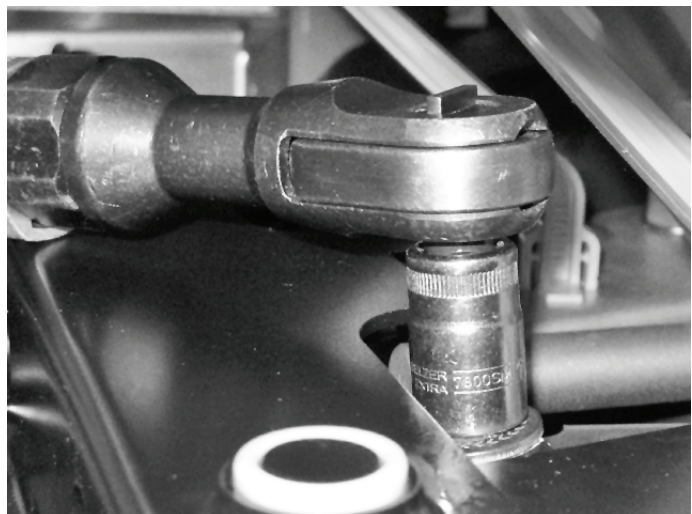



03.8. Take both cylinders out of the machine.

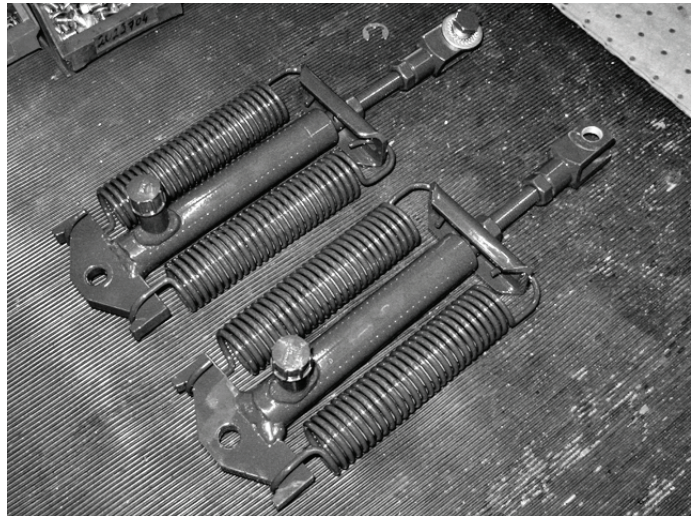

03.9. Remove the display elements.



03.10. Open the protective grid.





03.11. Unscrew both screws of the display.



03.12. Remove the display.

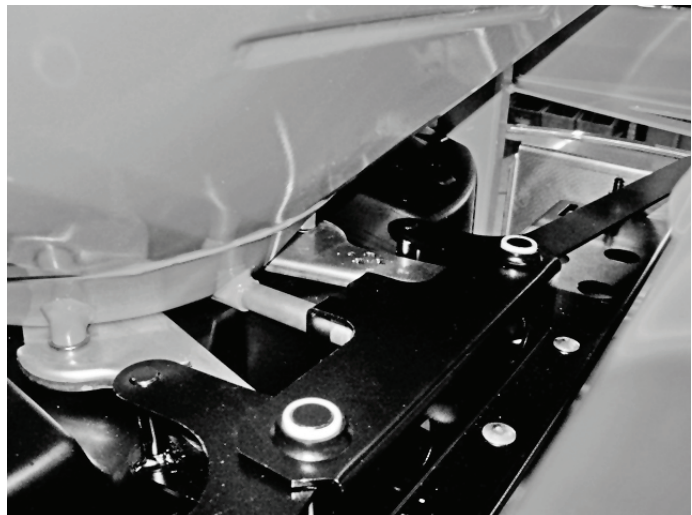

03.13. Close both holes from the inside using plugs.

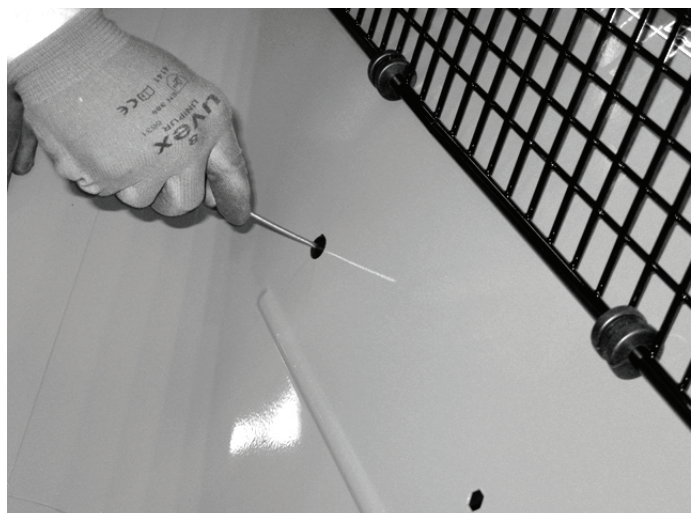



03.14. Close and lock the protective grid.





## 04. Checking the setting of the scale

*Requirements:*

*In order to check the metering slide adjustment, the mechanism must be freely movable.*

*The return spring is unhooked.*

*The hydraulic cylinder is unhooked.*

- 04.1. Set the stop lever to the value "130" and secure it using the T-handle.

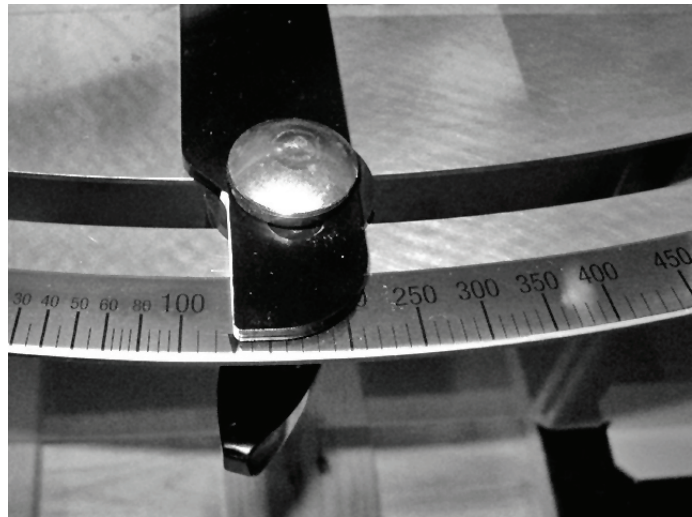

- 04.2. **Manually** pull the metering slide to the respective end stop.





- 04.3. Insert a pin with a diameter of  $\varnothing$  28 mm into the opening.  
*You can use a lower link pin of the MFS for this purpose.*



- 04.4. **Checking:** The pin must fit into the opening at zero clearance.  
*If this is not the case, please refer to the operating manual of the MDS, chapter "Checking and setting the metering slide", for further information.*

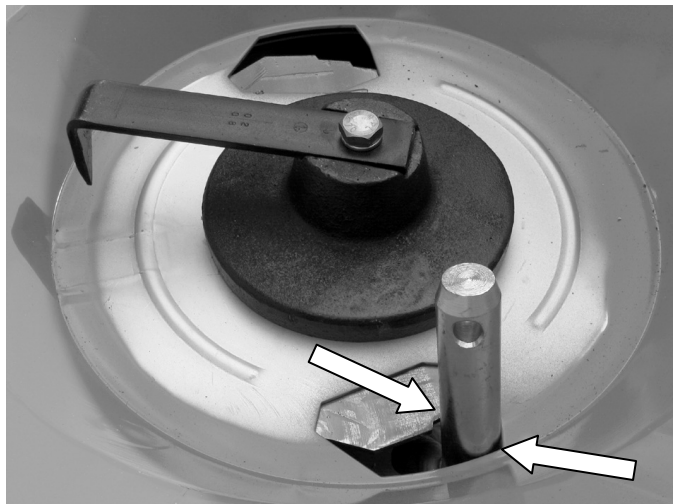

- 04.5. Remove the pin.

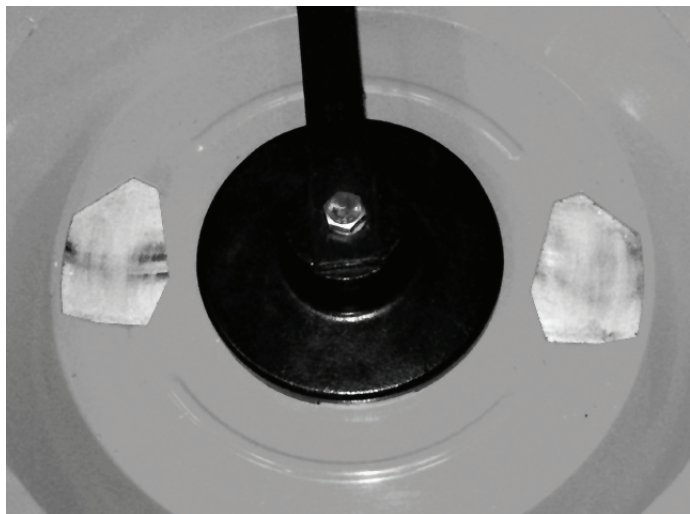



04.6. Remove the T-handles



04.7. Repeat the work steps 1-6 for the right metering slide.

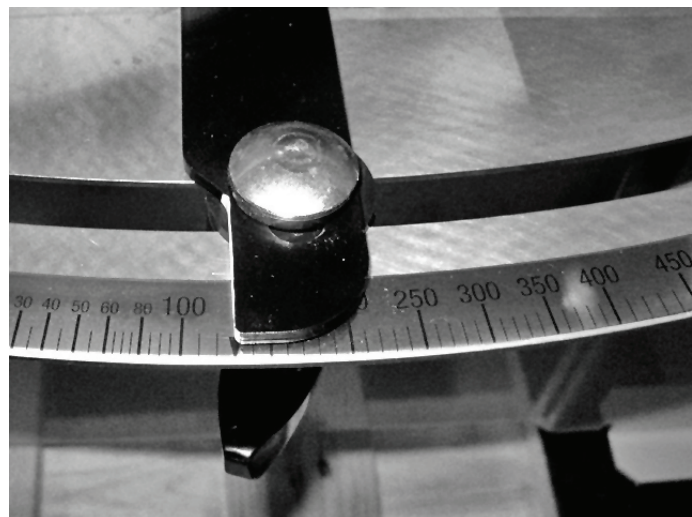

*For more information, please refer to the operating manual of the MDS.*





## 05. Installing the actuator

- 05.1. Screw the switch box onto the central panel from below.  
Tightening torque:  $\approx 7 \text{ Nm}$

### Legend

- a) Washer 6.4 x 12.5 x 1.6
- b) M6 x 20 round-head screw or lens head screw
- c) Nut M6

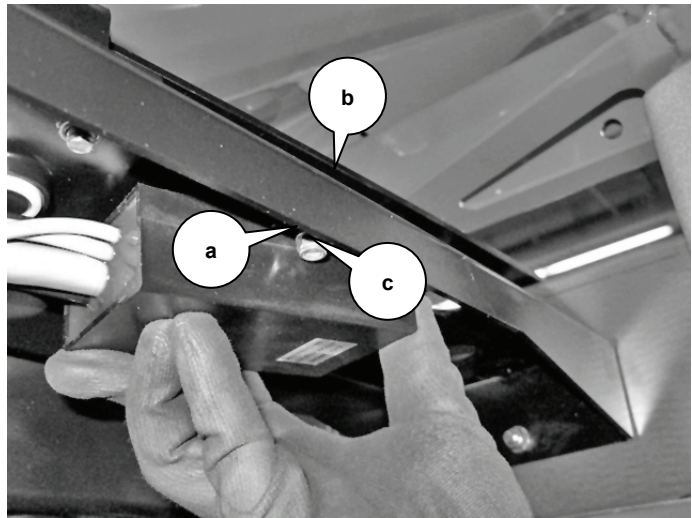

- 05.2. Viewed in the direction of travel, unscrew the right round-head screw from the panel.

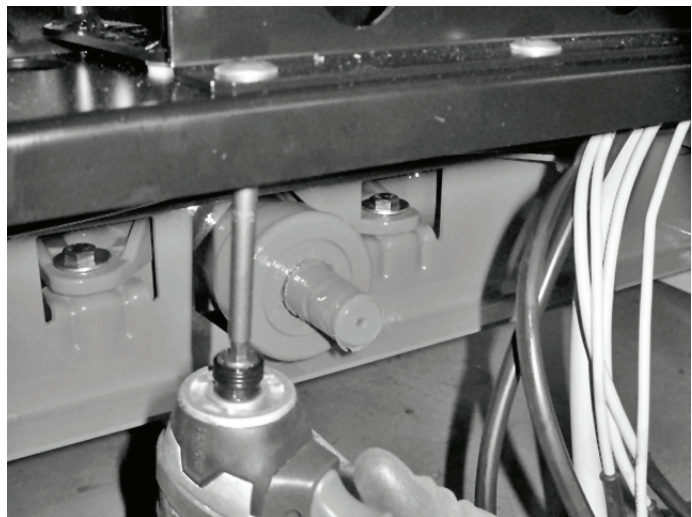

- 05.3. Press the pipe clamp together.

### Legend

- a) Pipe clamp  $\text{\O}13, \text{B20}$
- b) M8 x 25 round-head screw

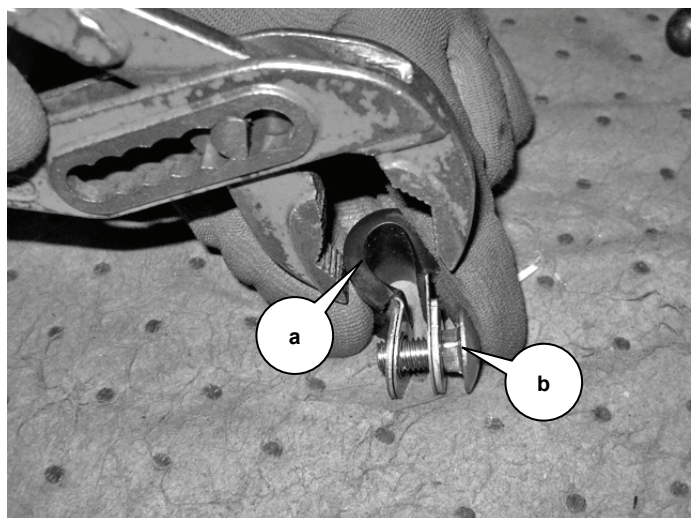



05.4. Lay the cable and screw on the pipe clamp.

Tightening torque: **15 Nm**

**Legend**

a) Washer 17 x 8.4 x 1.6

b) Nut M8

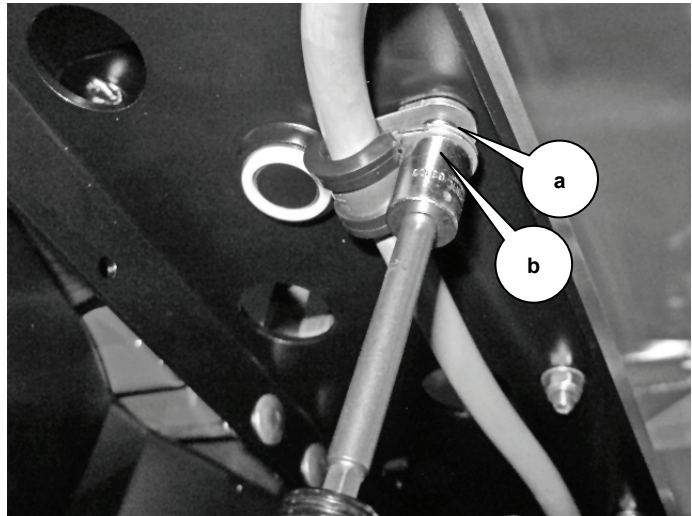

05.5. Insert the right and left bearing pin into the respective elongated hole.

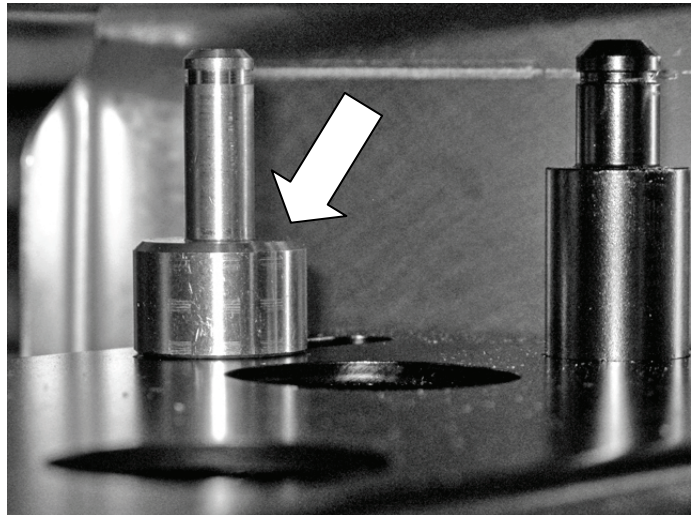

05.6. Manually position a washer and a hexagonal nut on the bottom side.

**Legend**

a) Nut M10

b) Washer 10.5 x 30 x 2.5

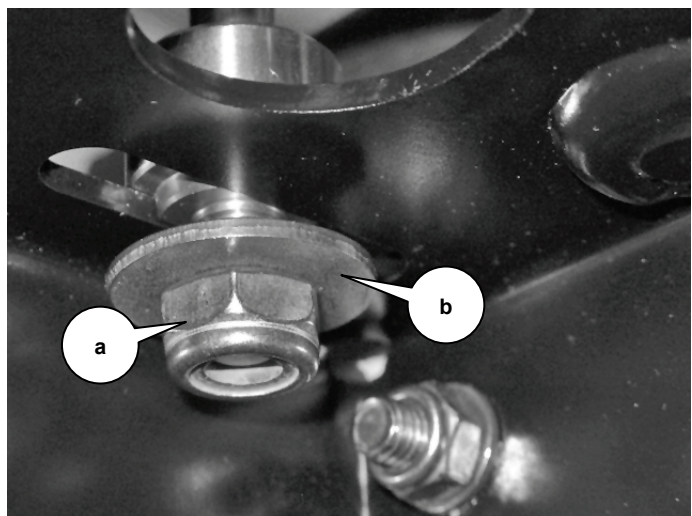



- 05.7. Screw in the piston rod until reaching a stop.  
*To this end, turn the piston rod clockwise.*

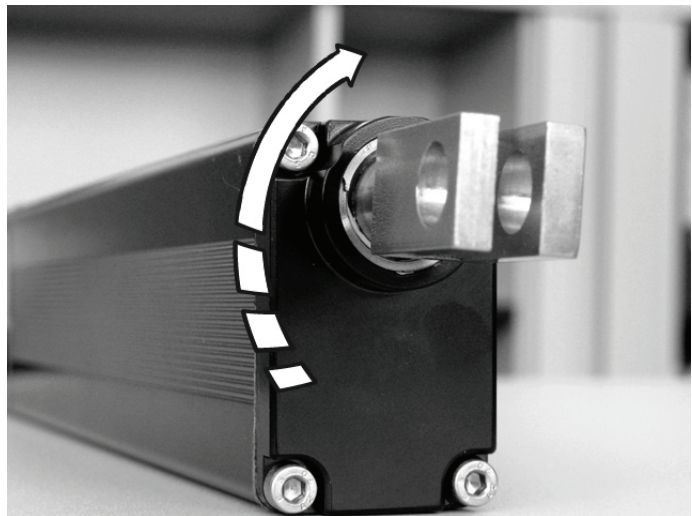

- 05.8. Turn the piston rod back by one half of a turn.  
*This way, the piston rod is no longer positioned on the limit switch of the actuator.*

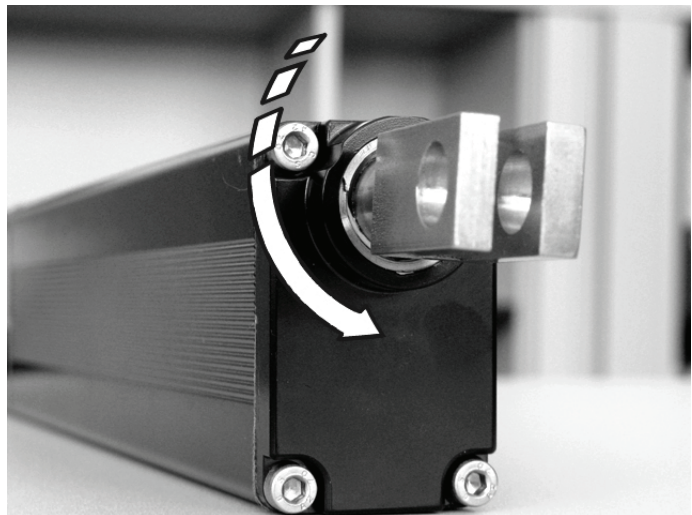

- 05.9. Insert the actuators on both sides and secure each of them using a retaining washer.  
*Guide the cable downwards.*

**Legend**

- a) Actuator  
b) Locking washer

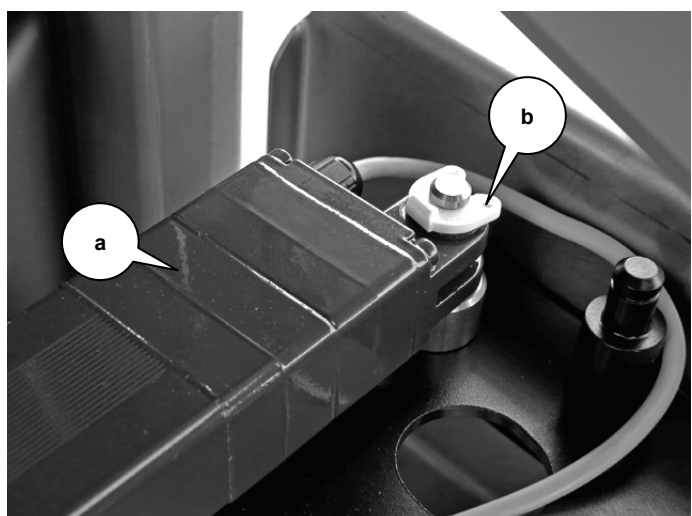



05.10. Slide both actuators inwards until they reach the end stop.

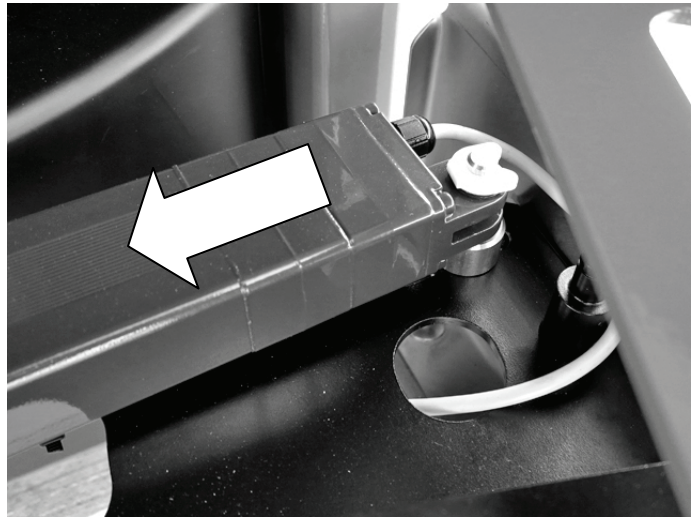



## 06. Installing cables/connecting actuators

- 06.1. Secure the cable on the bottom side of the panel using a cable tie.



- 06.2. Connect the actuators to the switch box **according to the marking**.





- 06.3. Secure the actuator cable in a **sufficient distance** to the connector using cable ties.



- 06.4. Tie together all connectors that are not required using cable ties.





## 07. Connecting actuators and sliders

07.1. Check the flange bolts.

*The flange bolts must fit into the guide.*



07.2. **Only applicable if a bolt does not fit:**

Deburr the bore in the guide component.

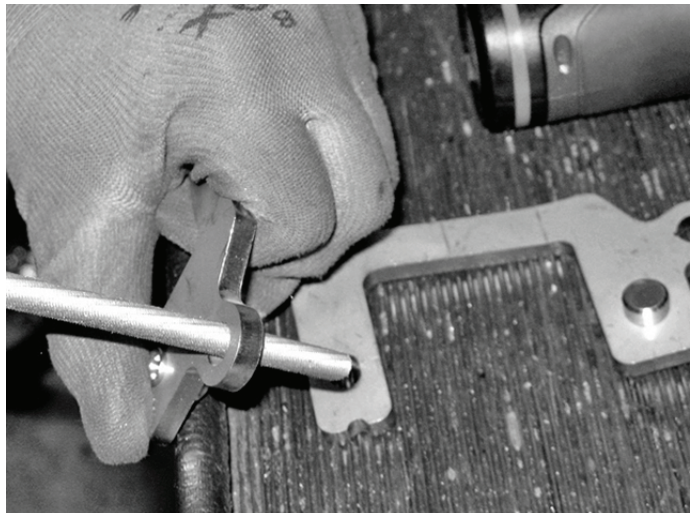

07.3. Set both metering slides to the middle position.

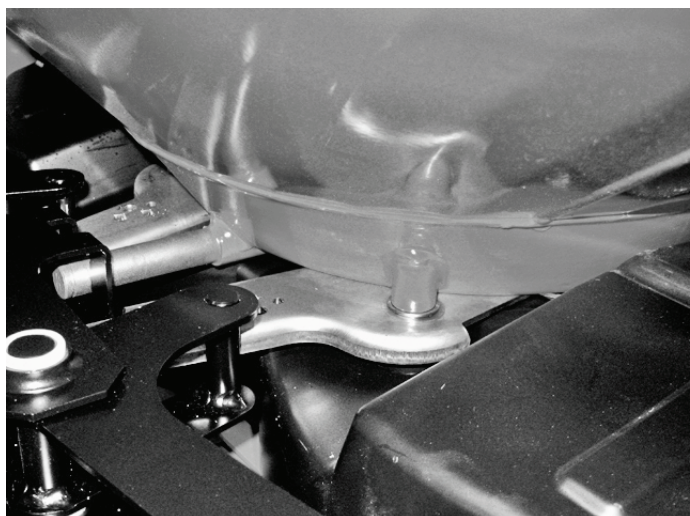



- 07.4. **Move** the stop lever towards the respective metering slide.  
*There may be **no clearance** between both components.*



- 07.5. Connect the guide to the slide.  
*There may be **no clearance** between the guide, the stop lever and the metering slide.*

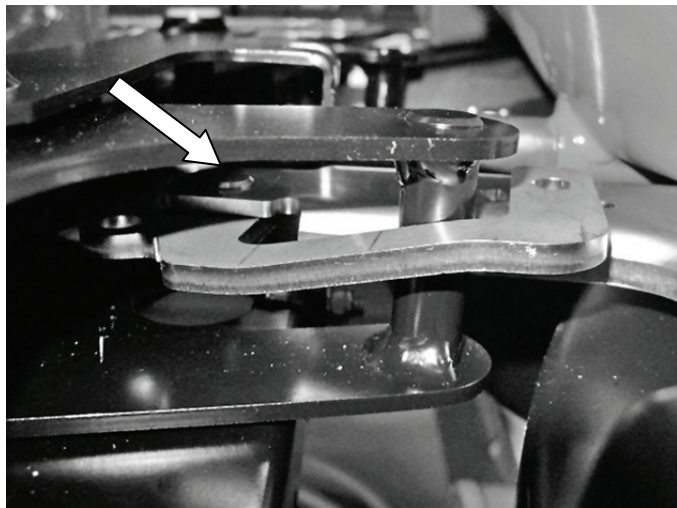

- 07.6. Screw both guides to the metering slides.  
Tightening torque: **15 Nm**

**Legend**

- a) M8 x 25 hex cap screw
- b) Washer 17 x 8.4 x 1.6
- c) M8 hexagonal nut

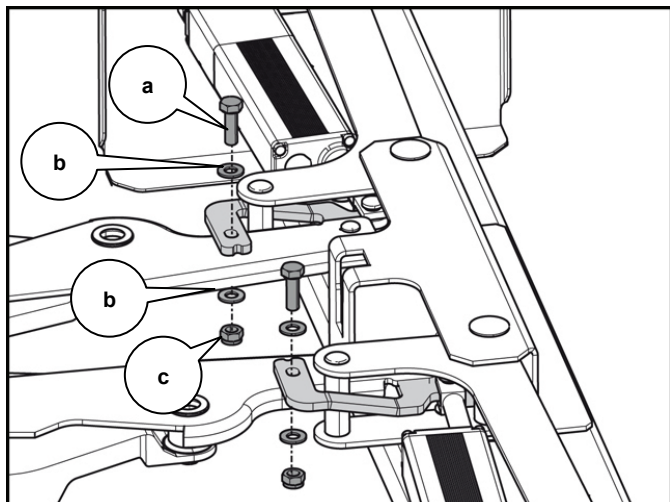





07.7. Greasing the guide:



07.8. Connect the actuators to the guides.

**Legend**

a) Flange bolt

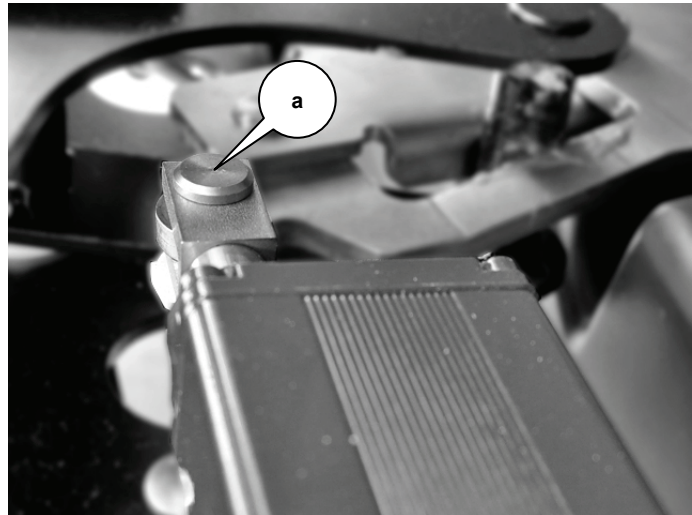

07.9. Secure both connecting pins.

The distance between the bottom edge of the flange bolt and the stop lever has to be 4 mm at least.

*Otherwise, the flange bolt and the stop lever may get jammed.*

**Legend**

a) Flange bolt

b) Locking washer

c) Stop lever

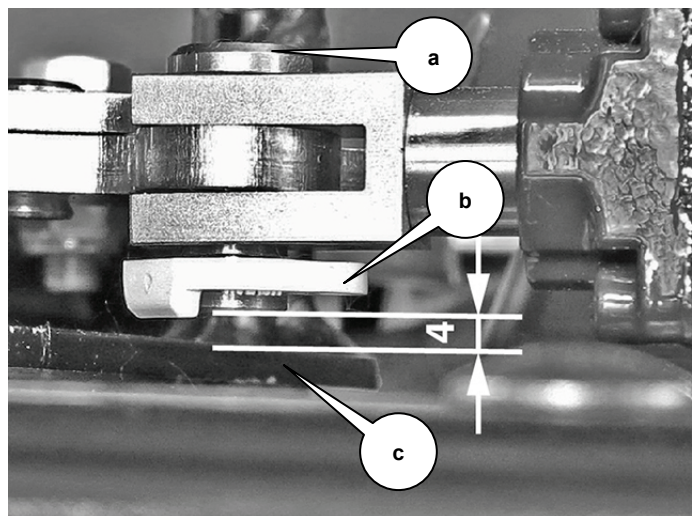



07.10. Insert the pin at the scale.

**Legend**

- a) Pin
- b) POM washer 13 x 40 x 3
- c) POM washer 13.5 x 30 x 2.5

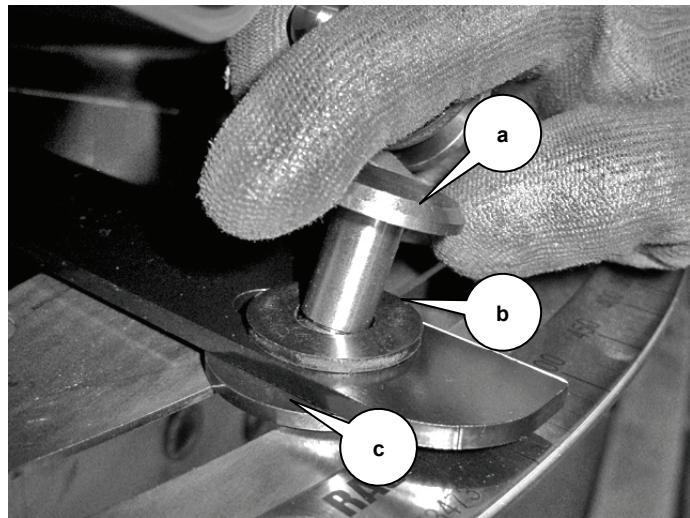

07.11. Secure the flange bolt.

**Legend**

- a) POM washer 13.5 x 30 x 2.5
- b) POM washer 13 x 40 x 3
- c) Washer 13 x 24 x 2.5
- d) Locking washer

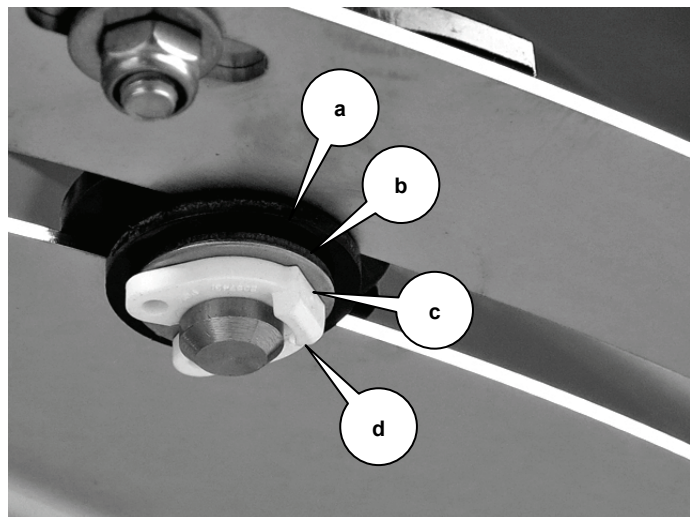

07.12. Push the actuators outwards until the stop lever is located approx. half a line above 550 (arrow).





07.13. Tighten the nut at the bearing pin.  
Tightening torque:  $\approx 30$  Nm

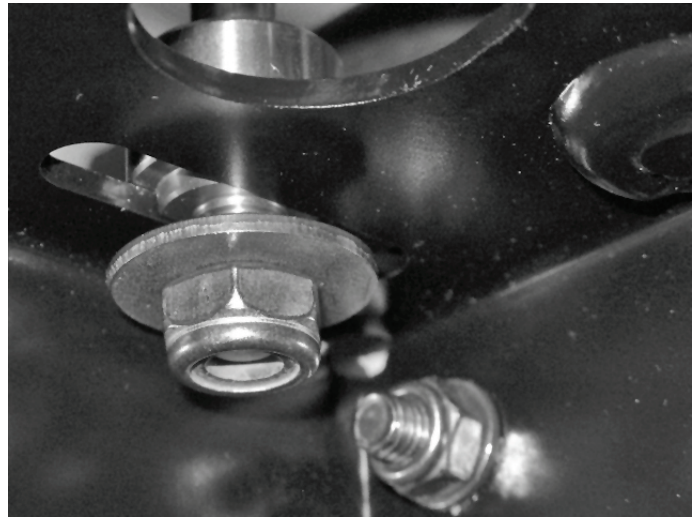



## 08. QUANTRON-A

- 08.1. Firmly screw on one of the retaining plates for the QUANTRON-A.

**Legend**

- a) M5 x 10 lens head screw

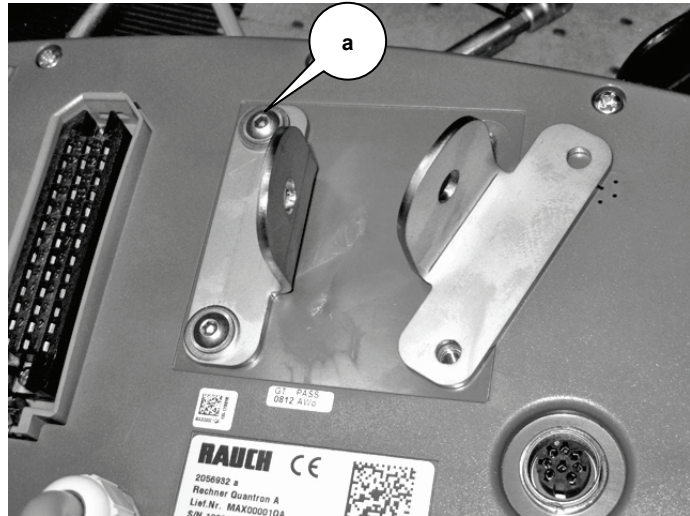

- 08.2. Attach the retainer to the retaining plate using one screw.

**Legend**

- a) Washer 8.4 x 24 x 2

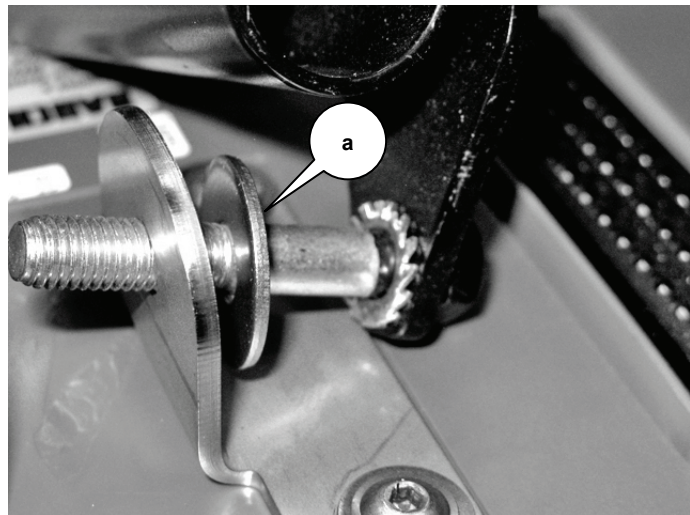

- 08.3. Position the spacer sleeve and the second retaining plate and mount them loosely.

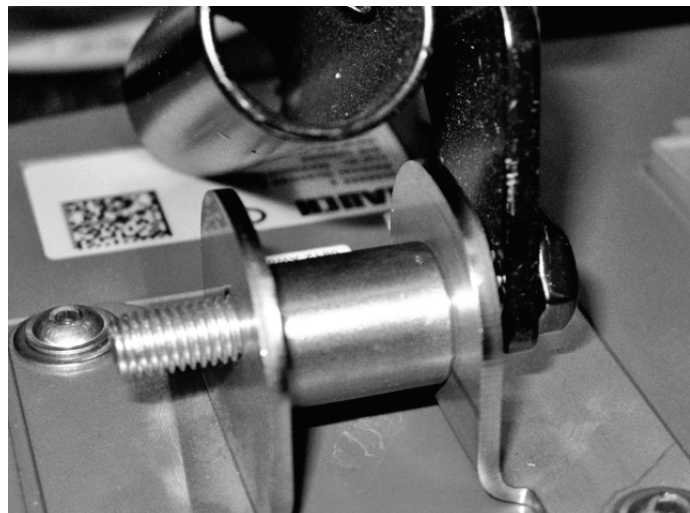



08.4. Position and tighten the nut.

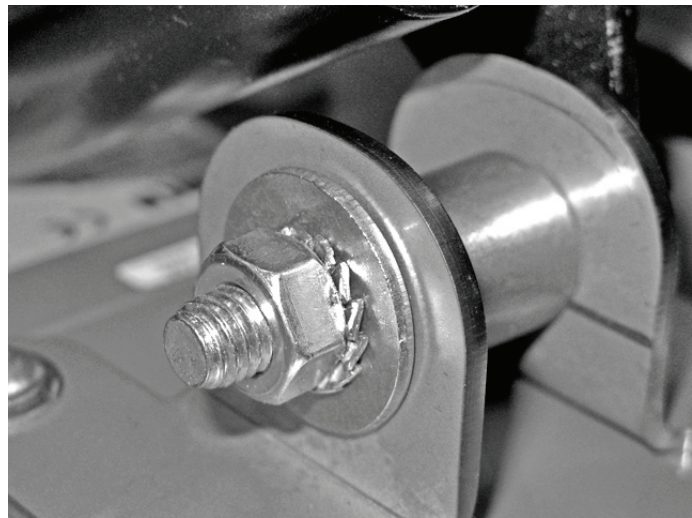

08.5. Tighten the lens head screws at the second retaining plate.

**Legend**

a) *M5 x 10 lens head screw*

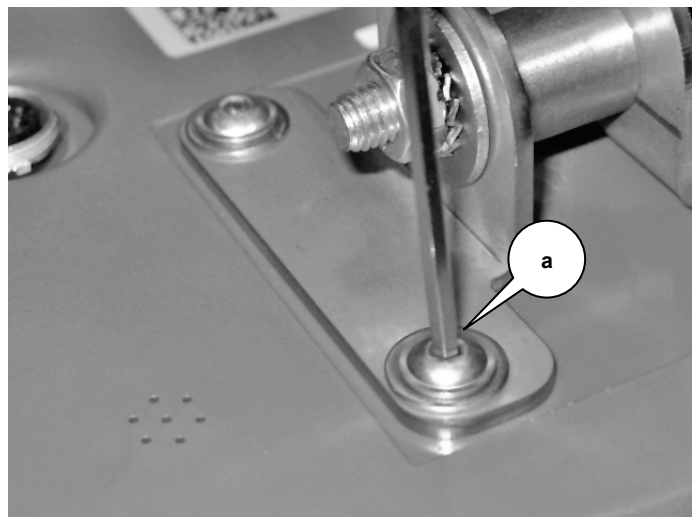



## 09. Calibrating the QUANTRON-A

**⚠ DANGER!**



### **Metering slide is externally operated**

Risk of shearing and crushing! You may loose limbs!

- ▶ Keep the protective grid closed.
- ▶ Keep sufficient distance to all moving parts of the spreader.
- ▶ Observe the operating manual of the spreader, in particular the chapter on safety!

09.1. Connect the QUANTRON-A to the spreader.

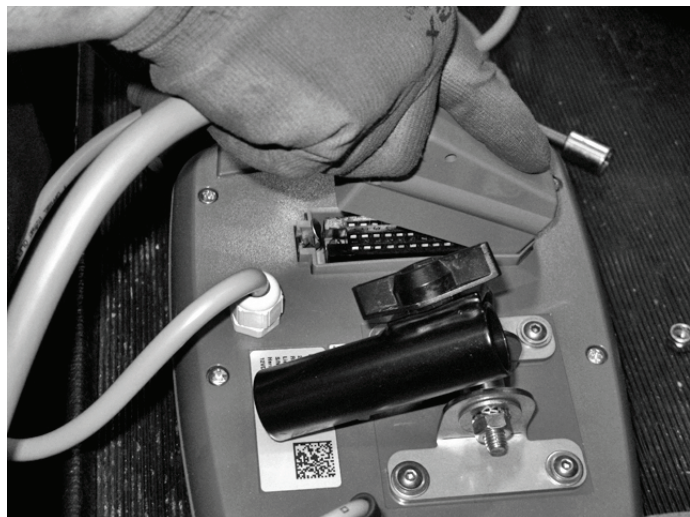

09.2. Connect the QUANTRON-A to the power supply.

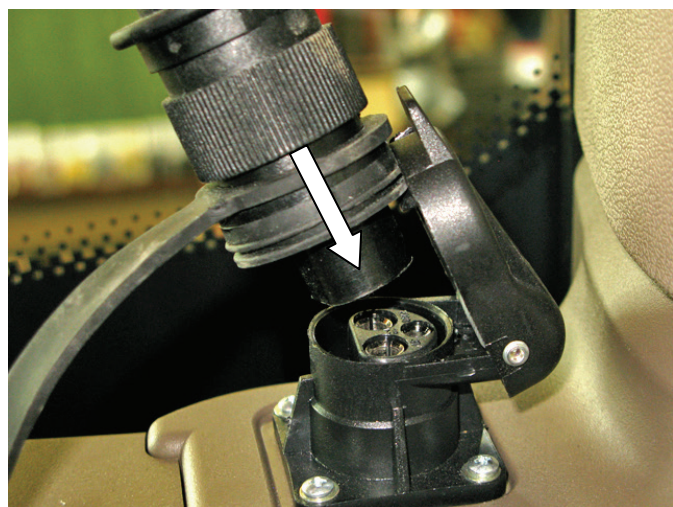



09.3. Switch on the QUANTRON-A.



09.4. Press the **Menu** button.

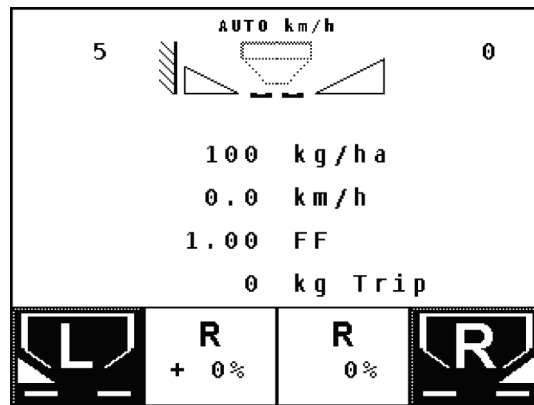

09.5. Select **System / Test > Service** and confirm by pressing **ENTER**.

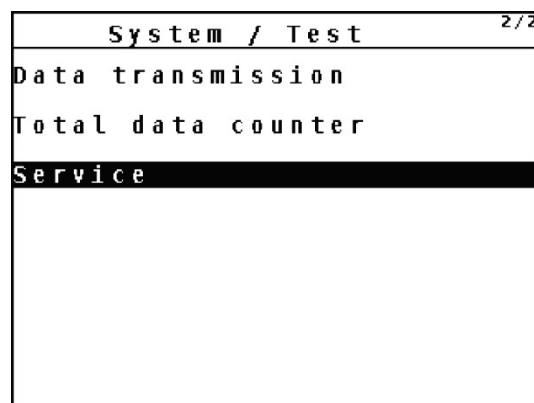



09.6. Enter the code **3354** using the **arrow keys** and confirm by pressing **ENTER**.

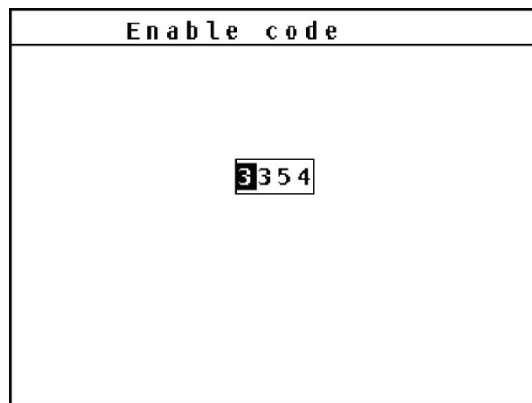

09.7. Select **Machine options > Max. scale** and confirm by pressing **ENTER**.

Machine options		1/3
Hopp level sensor		✓
Telimat sensor		✓
Actuator		RH03
<b>Max. scale</b>		<b>410</b>
Weigh cells		
MMC		
drop point		

09.8. Press **ENTER** multiple times and select the maximum value **"550"**.

Machine options		1/3
Hopp level sensor		✓
Telimat sensor		✓
Actuator		RH03
<b>Max. scale</b>		<b>550</b>
Weigh cells		
MMC		
drop point		





09.9. Call up **Service** by pressing **ESC** multiple times.



09.10. Select **Actuator Adjustment** and press **ENTER**.

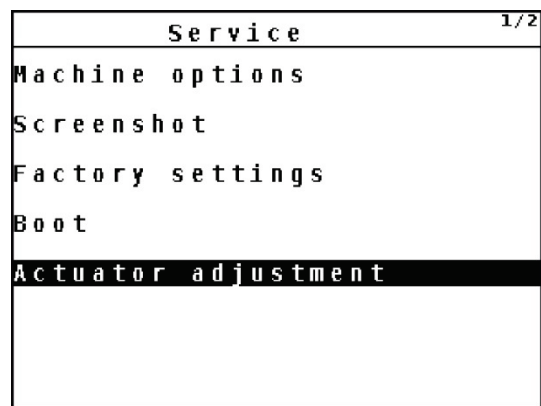

09.11. Move the **right slide** to the lower end stop using the **function keys**.

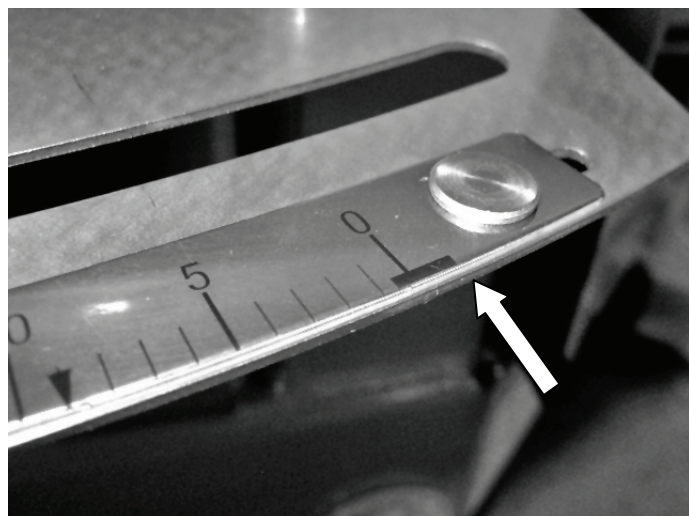



09.12. Set the **right slide** to the value "0" using the **function keys** and press **ENTER**.

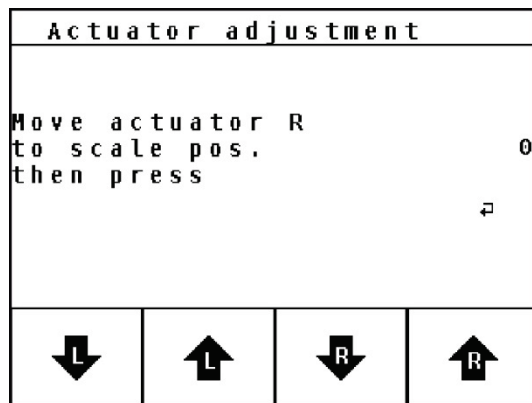

09.13. Set the **right slide** to the value **130** using the **function keys** and press **ENTER**.

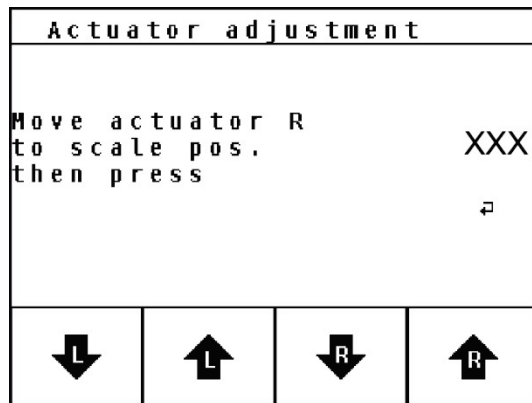

09.14. Set the **right slide** to the value **550** using the **function keys** and press **ENTER**.

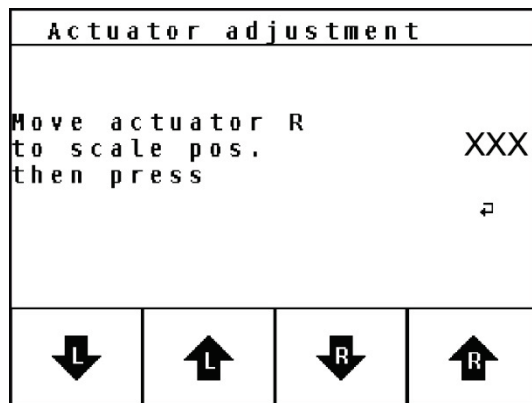



09.15. Set the **right slide** to a value between "0" and the lower end stop using the **function keys**.

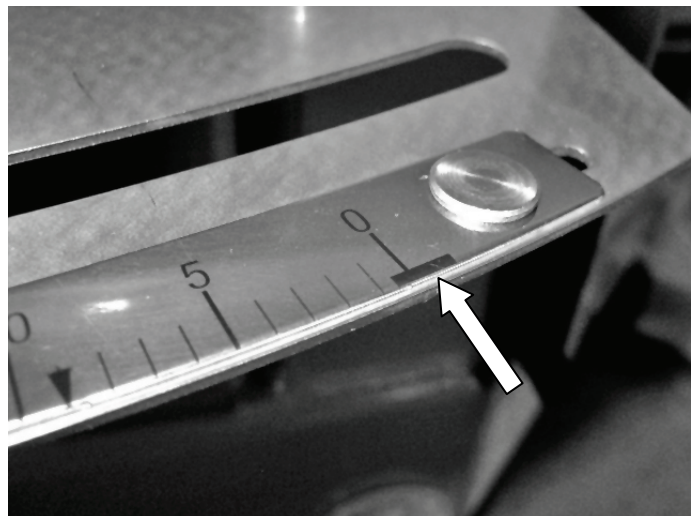
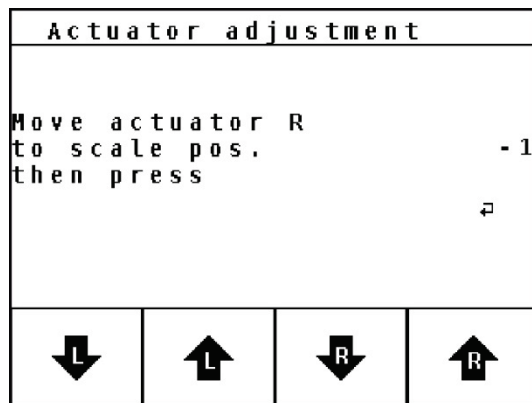

09.16. Carry out a **visual inspection**:  
The right slide must now be completely closed.  
*If the slide is still open, please refer to chapter 10 "If a slide was partially open during calibration" for further information.*

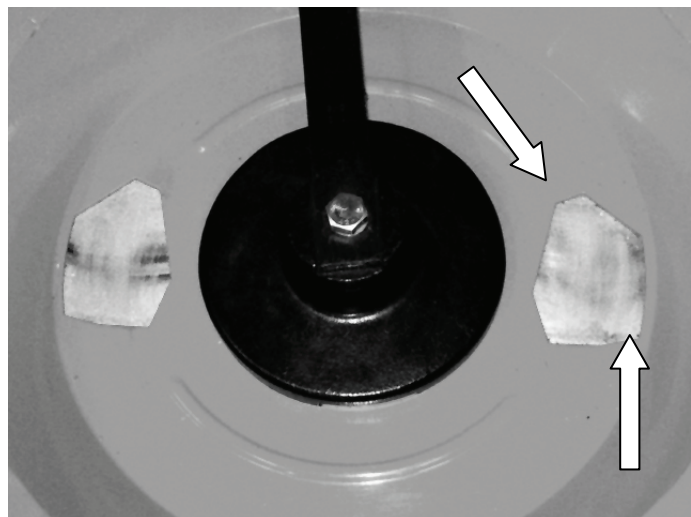



09.17. Press **ENTER**.

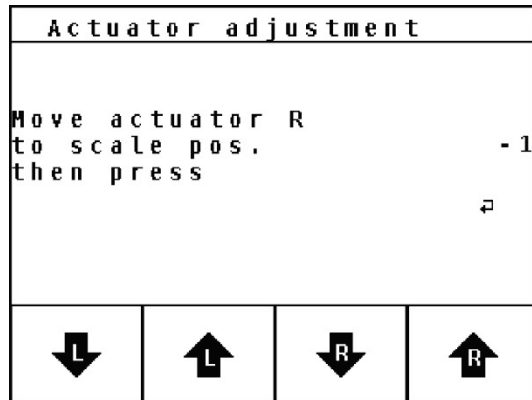

09.18. Set the **left slide** to the value "0"  
using the **function keys** and press  
**ENTER**.

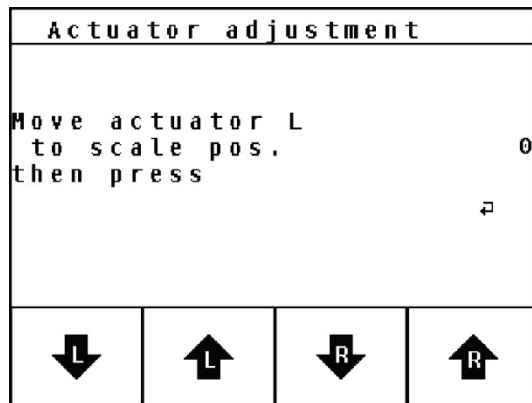

09.19. Set the **left slide** to the value **130**  
using the **function keys** and press  
**ENTER**.

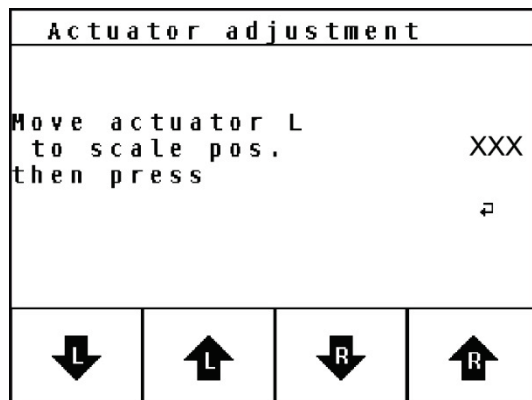



09.20. Set the **left slide** to the value **550** using the **function keys** and press **ENTER**.

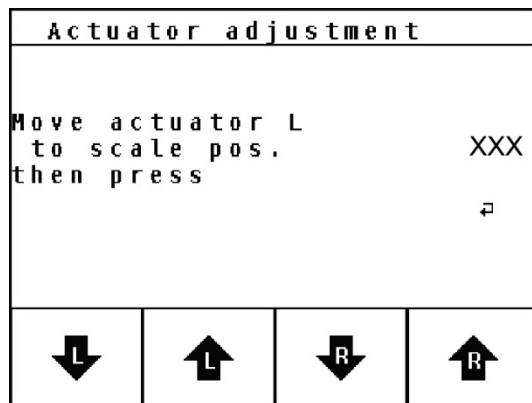

09.21. Set the **left slide** to a value between "0" and the lower end stop using the **function keys**.

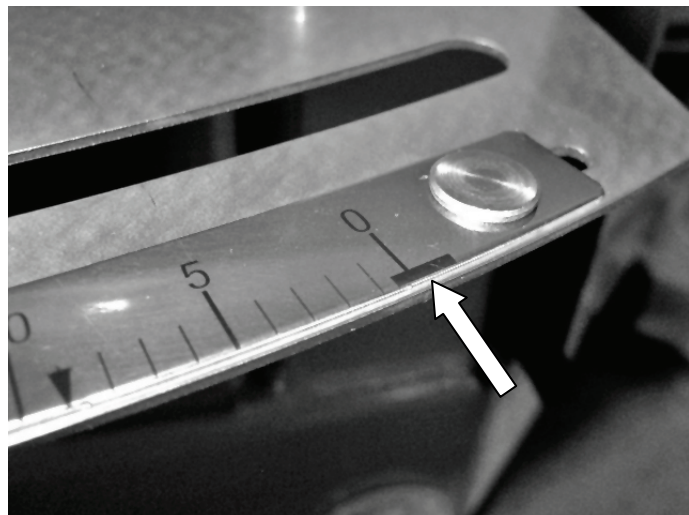
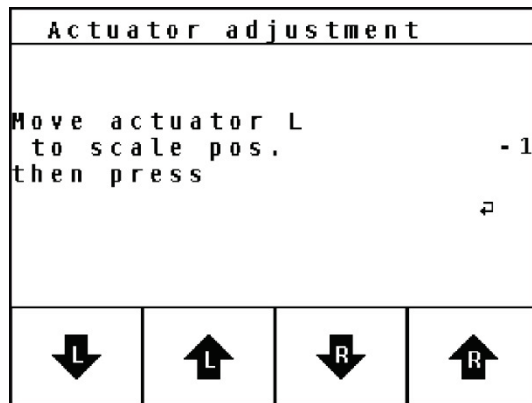



09.22. Carry out a **visual inspection**:

The left slide must now be completely closed.

*If the slide is still open, please refer to chapter 10 "If a slide was partially open during calibration" for further information.*

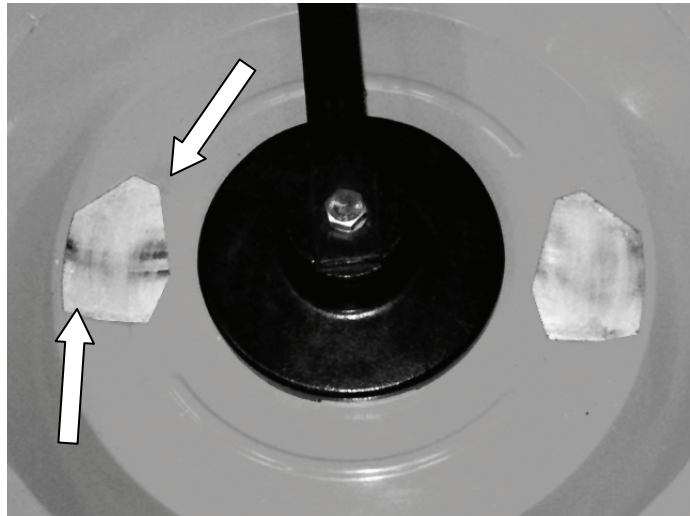

09.23. Press **ENTER**.

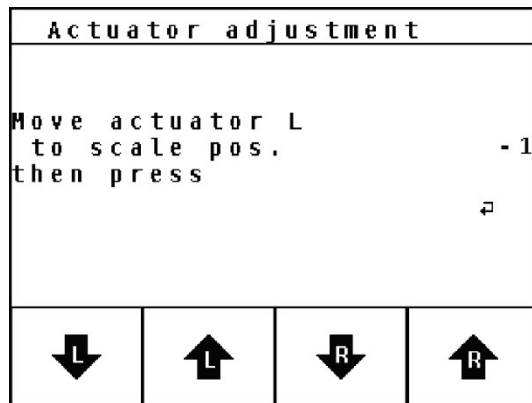

09.24. Call up the operating screen by pressing **ESC** multiple times.





## 10. If a slide was partially open during calibration

### ⚠ DANGER!



#### **Metering slide is externally operated**

Risk of shearing and crushing! You may loose limbs!

- ▶ Switch off the engine of the tractor and/or the hydraulic unit.
- ▶ Remove the ignition key.
- ▶ Switch off the QUANTRON-A and disconnect it from the spreader
- ▶ Park the spreader according to the operating manual.
- ▶ Completely disconnect the spreader from the tractor and/or from the hydraulic unit.
- ▶ Observe the operating manual of the spreader, in particular the chapter "Safety"!

### 10.1. Loosen the nut at the bearing pin.

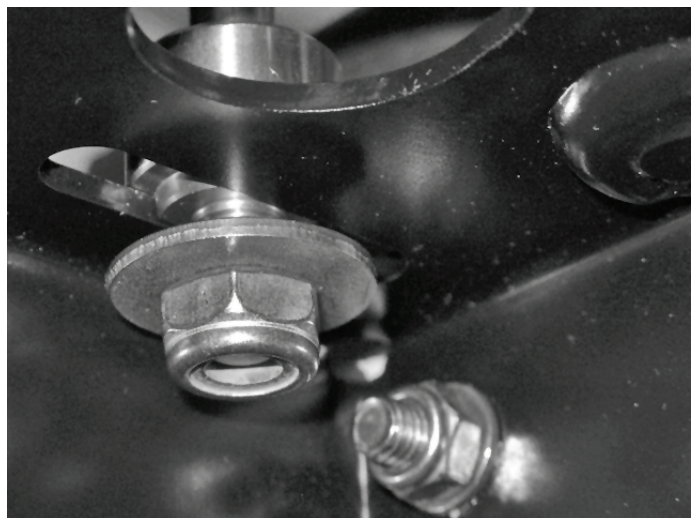



10.2. Move the cylinder.

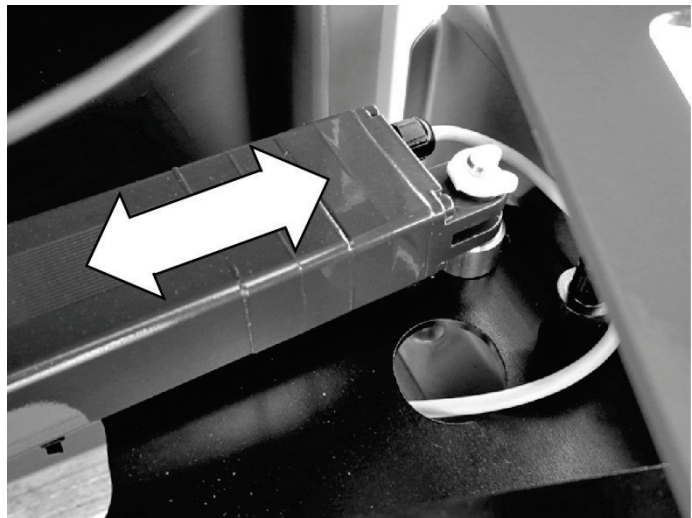

10.3. Tighten the nut at the bearing pin.  
Tightening torque:  $\approx 30 \text{ Nm}$



10.4. Repeat the calibration (see chapter 09)







## 11. Checking the calibration

### ⚠ DANGER!



#### Metering slide is externally operated

Risk of shearing and crushing! You may loose limbs!

- ▶ Keep the protective grid **closed**.
- ▶ **Keep sufficient distance** to all moving parts of the spreader.
- ▶ Observe the operating manual of the spreader, in particular the chapter "Safety"!

- 11.1. Connect the QUANTRON-A to the spreader.

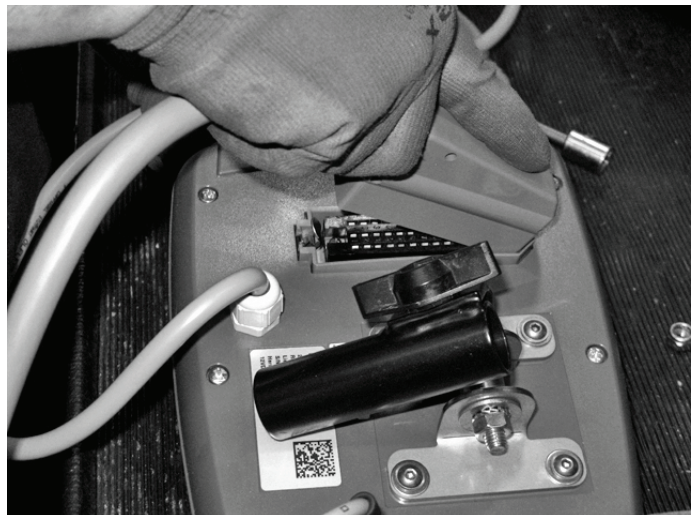

- 11.2. Connect the QUANTRON-A to the power supply.





11.3. Press the **Menu** button.

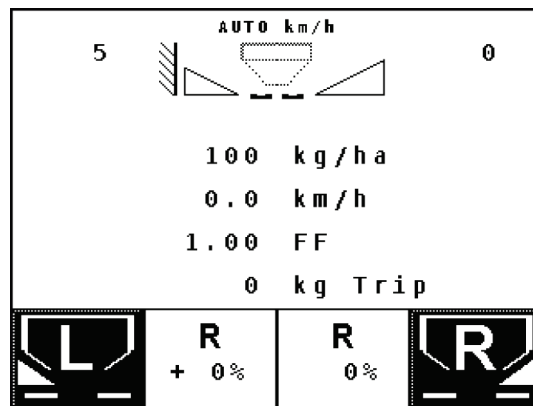

11.4. Select **System / Test > Test / Diagnosis > Test points sliders** and confirm by pressing **ENTER**.

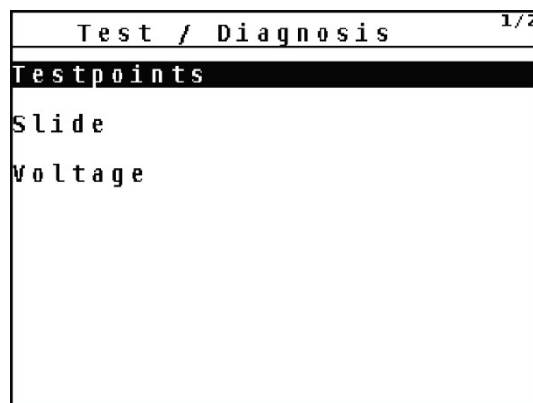

11.5. Move the slides to the test points, check on both sides and confirm accordingly.

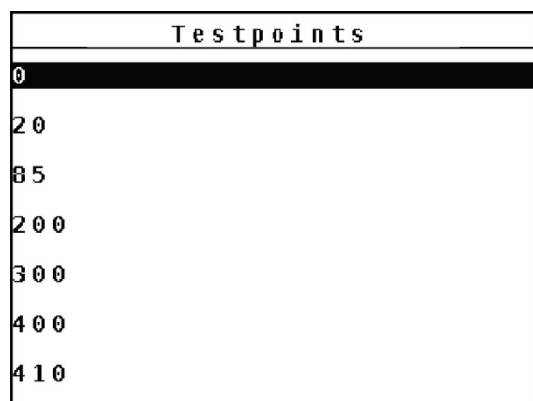



## Conversion kit MDS



- 11.6. Call up the operating screen by pressing **ESC** multiple times.





## 12. Setting the QUANTRON-A

### ⚠ DANGER!



#### Metering slide is externally operated

Risk of shearing and crushing! You may loose limbs!

- ▶ Keep the protective grid **closed**.
- ▶ **Keep sufficient distance** to all moving parts of the spreader.
- ▶ Observe the operating manual of the spreader, in particular the chapter "Safety"!

*The settings in this chapter can only be made if you have set the QUANTRON-A to "Expert" mode.*

*For further information, please refer to the QUANTRON-A operating manual.*

### 12.1. Press **Menu**.

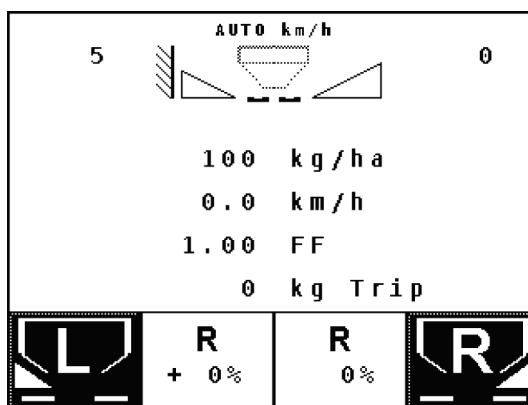

### 12.2. Select **Fertiliser settings > Disc type** and press **ENTER**.

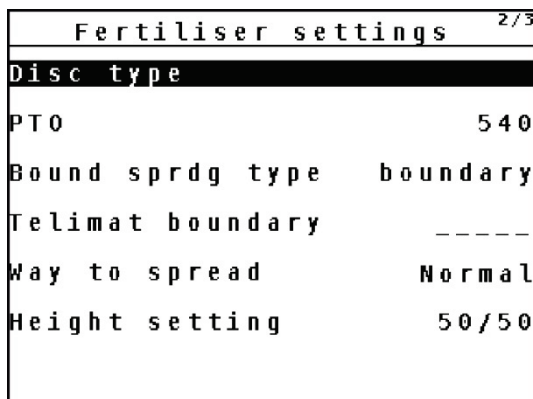



12.3. Select the installed disc type and press **ENTER**.

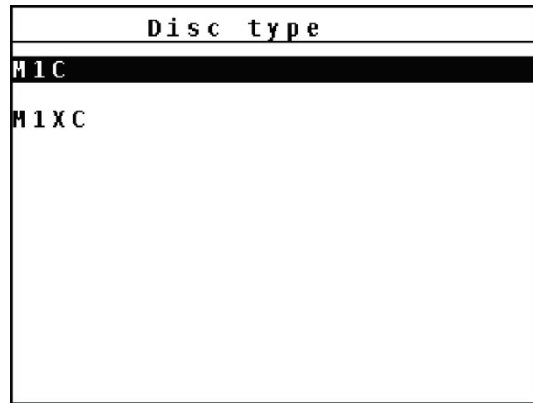

12.4. Call up the operating screen by pressing **ESC** multiple times.



12.5. Press **Menu**.

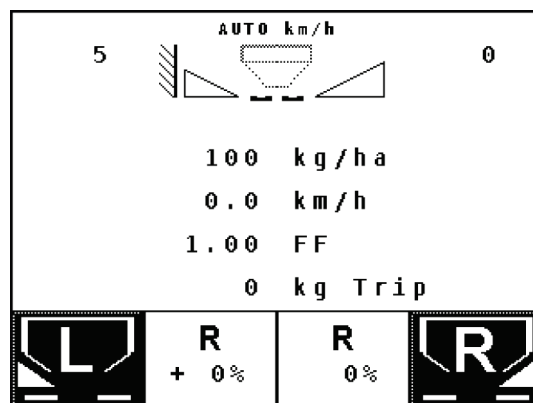



12.6. Select **Fast emptying** and press **ENTER**.

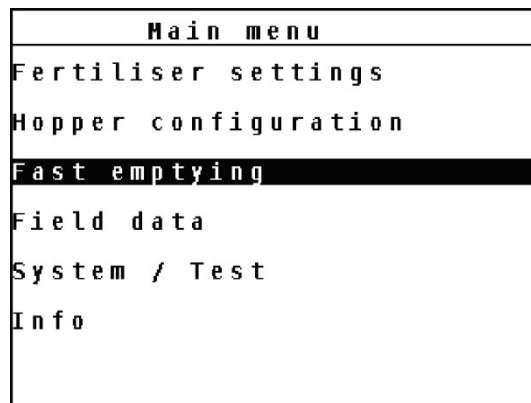

12.7. Select both sides using the function keys.

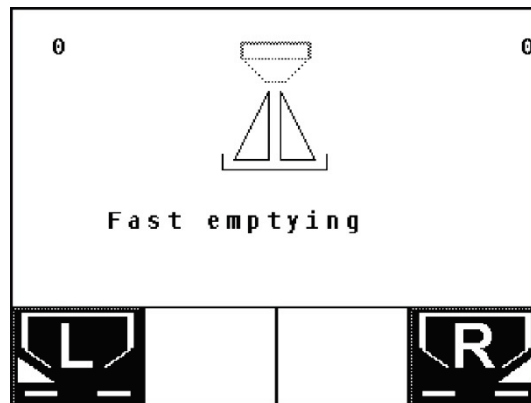

12.8. Press **Start**.





12.9. Switch off the QUANTRON-A.



12.10. **Disconnect the QUANTRON-A** from the power supply and from the spreader.

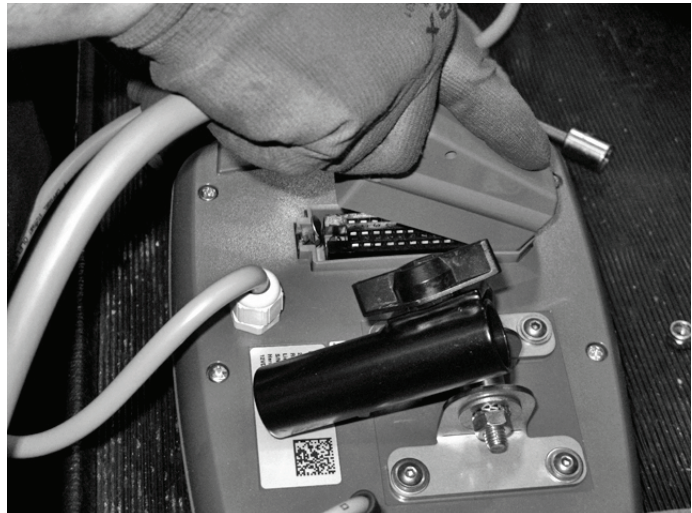



## CAUTION

### Damage caused by water and dirt

Water and dirt can damage the connector

- ▶ The opening of the connector must face downward.

12.11. Stow away the machine cable.

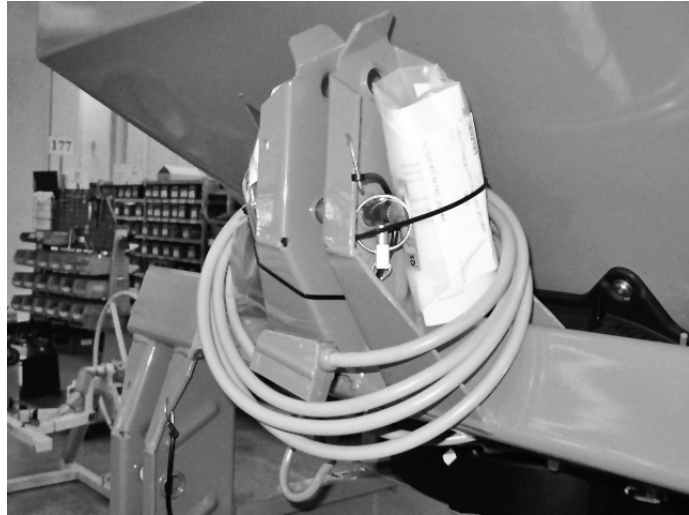





Conversion kit MDS





Équipement MDS





## 01. Sécurité

**Tous les travaux effectués sur les distributeurs sont soumis aux indications suivantes :**

- ▶ Seul le **personnel formé** et qui **porte des gants de protection** peut procéder aux travaux de montage.
- ▶ Vider complètement le distributeur et l'éteindre **conformément** aux **instructions de service** ! (vanne ouverte, ressort de rappel détendu)
- ▶ Éteindre le **tracteur** et retirer **la clé du contact**.
- ▶ Arbre de transmission, raccords électriques et hydrauliques coupés !
- ▶ **Maintenir fermée** la grille de protection au niveau du distributeur.
- ▶ Respecter la notice d'instructions du distributeur ! En particulier le chapitre « Sécurité ».

**Si le distributeur est relié au tracteur, au groupe hydraulique ou au QUANTRON :**

- ▶ Maintenir une distance suffisante avec la vanne de dosage et tous les éléments mobiles du distributeur.



## 02. Avant de commencer

- 02.1. Arrêter la machine et couper **entièrement** les raccords électriques et hydrauliques du tracteur **conformément à la notice d'instructions**.



### ⚠ AVERTISSEMENT



#### **Danger de coincement et de coupure en cas d'épandeur à engrais minéral déposé**

Si en dévissant la vis de fixation (commandes des vannes K et R), le ressort de rappel est tendu, le levier de butée peut heurter brutalement l'extrémité de la fente de guidage.

Il existe un danger d'écrasement, de cisaillement et d'autres blessures.

- ▶ Arrêter la machine uniquement avec la vanne de dosage entièrement ouverte (ressort de rappel détendu).
- ▶ **Ne jamais** placer ses doigts dans la fente de guidage du réglage de la dose d'épandage.

- 02.2. Éteindre le tracteur et retirer la clé du contact.





02.3. Vérifier que le kit de pièces est complet.

### Légende

- a) QUANTRON-A
- b) Clé USB
- c) Fixation
- d) 2 x support
- e) Pièce de guidage droite et gauche
- f) Vérins
- g) Câble
- h) Câble machine
- i) Attache-câbles
- j) Rondelles 13 x 24 x 2,5
- k) 6 rondelles de sécurité
- l) Boulons épaulement
- m) Rondelles 8,4 x 24 x 2,0
- n) Écrous hexagonaux M10
- o) Écrous hexagonaux M6
- p) Vis à tête bombée M5 x 10
- q) Écrous hexagonaux M8
- r) Vis à six pans M8 x 20
- s) Rondelles 6,4 x 12,5 x 1,6
- t) Vis à tête plate M6 x 20
- u) Boulons d'appui Ø9,2 / M10
- v) Boulons Ø30 / 12 x 37
- w) Rondelles POM 13 x 40 x 3
- x) Vis à tête plate M8 x 25
- y) Vis à tête bombée M6 x 20
- z) Rondelles 8,4 x 17 x 1,6
- aa) Collier de fixation Ø13, B20
- bb) Rondelles POM 13,5 x 30 x 2,5 (noir)
- cc) Bouchons
- dd) Bague d'entretoise 12,5 x 17,2 x 22
- ee) Rondelles 10,5 x 30 x 2,5

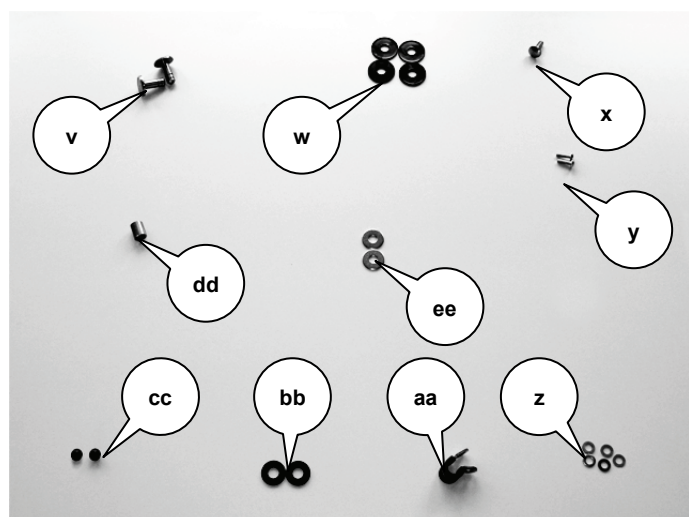
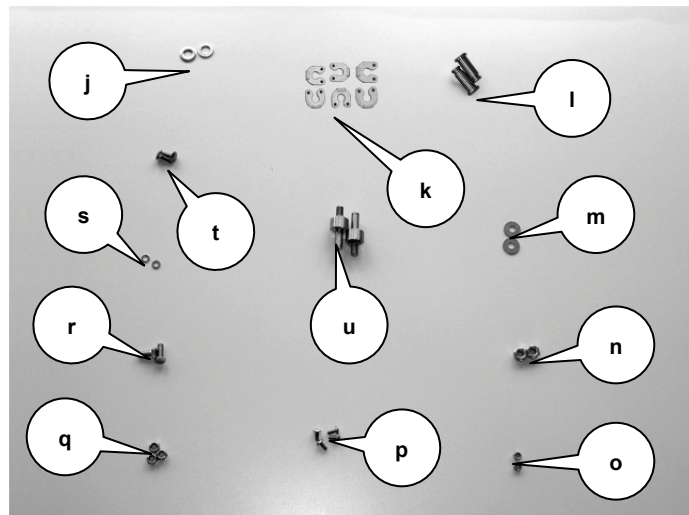
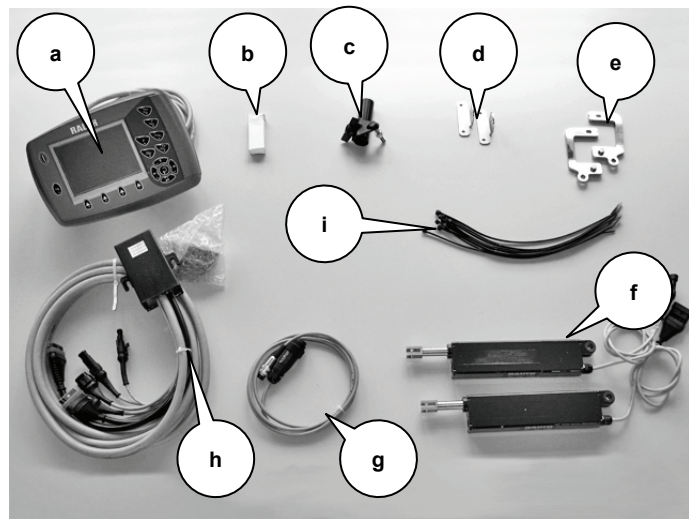



### 03. Démonter le cylindre

#### ▲ AVERTISSEMENT



#### Risque de blessure dû à de l'huile hydraulique s'échappant sous pression

L'huile hydraulique s'échappant sous pression peut pénétrer dans la peau, vous blesser sévèrement et nuire à l'environnement.

- ▶ Porter un équipement de protection individuelle (au min. des gants de protection et lunettes de protection)
- ▶ Mettre les installations hydrauliques **hors pression** avant tous les travaux d'entretien.
- ▶ En cas de blessures, contacter immédiatement un médecin ! Risque d'infection !
- ▶ Éliminer de manière conforme l'huile hydraulique de fuite.

03.1. Placer un bac d'huile adapté sous chaque cylindre.





03.2. Retirer les conduites hydrauliques des cylindres.

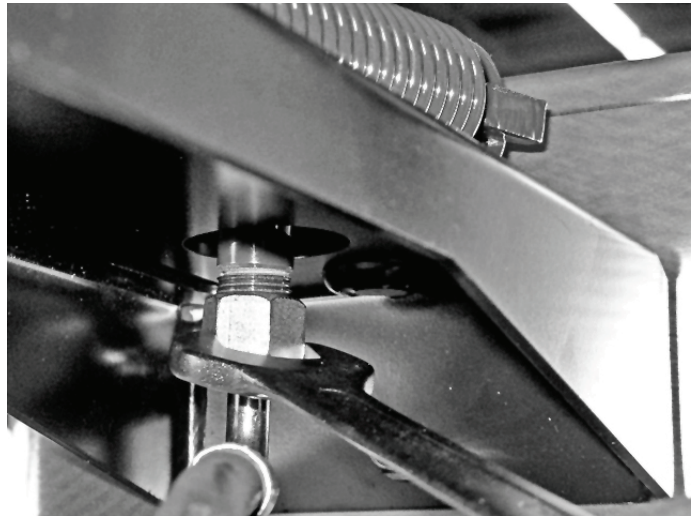

03.3. Vider l'huile dans le bac et retirer les conduites hydrauliques.

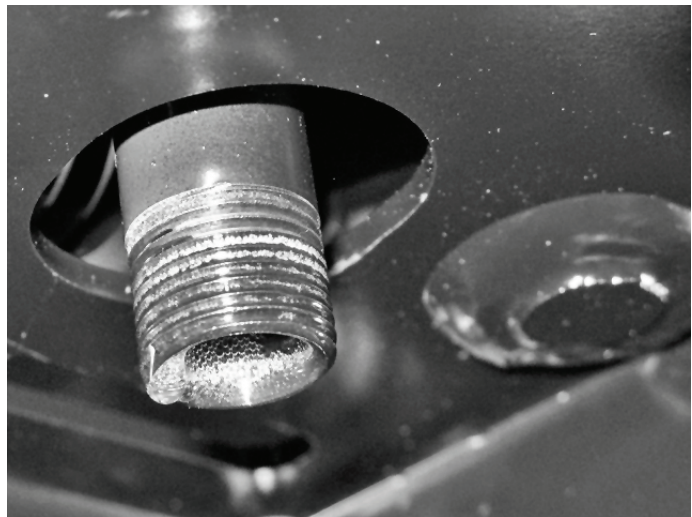

03.4. Retirer les rondelles de sûreté au niveau des cylindres.

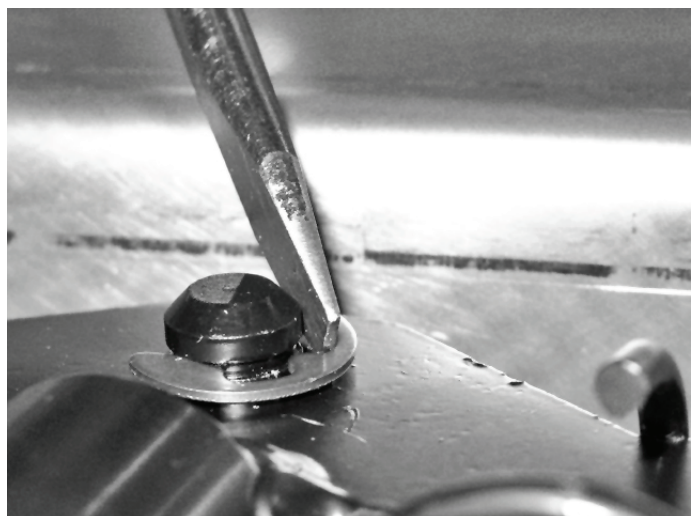



- 03.5. Retirer les cylindres des axes et les déposer sur la console centrale.

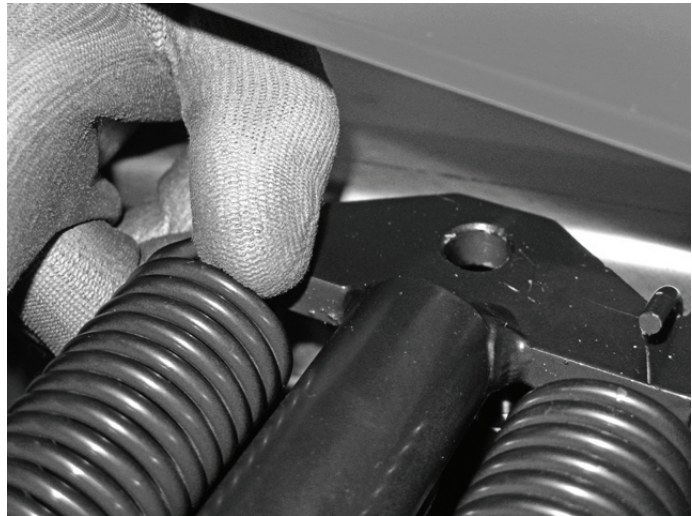

- 03.6. Placer les deux leviers sur « 0 ».  
*Les cylindres sont ainsi tirés vers le centre de la machine. Les vis au niveau des chapes des bielles sont maintenant accessibles.*



- 03.7. Desserrer et retirer les vis au niveau des chapes des bielles.

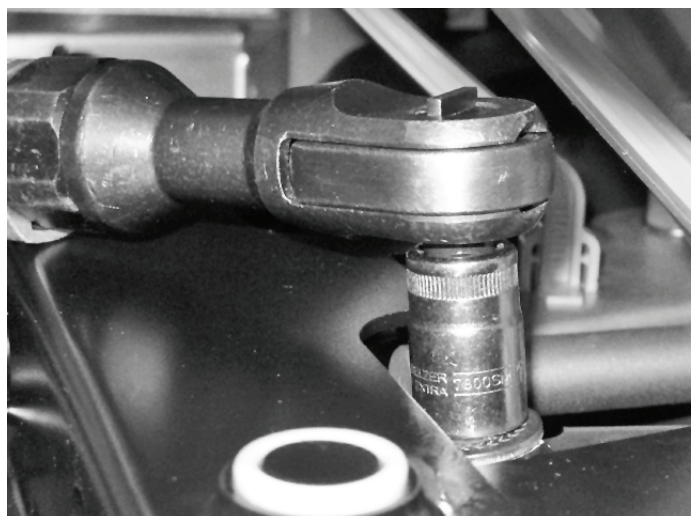





03.8. Retirer les deux cylindres de la machine.

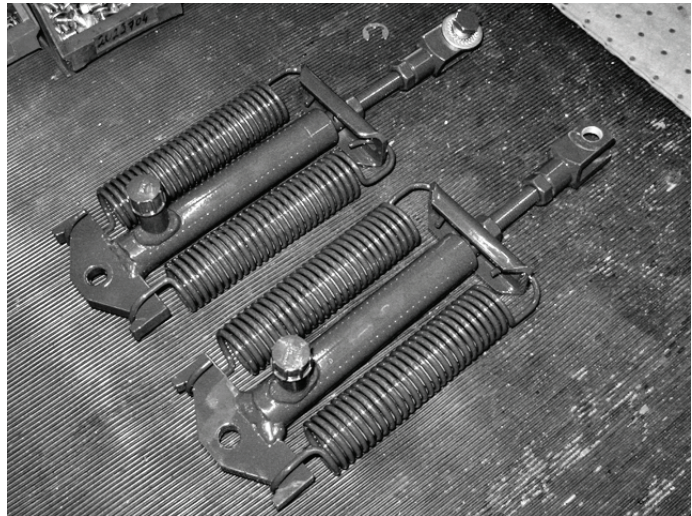

03.9. Retirer les éléments d'affichage.



03.10. Ouvrir la grille de protection.





03.11. Dévisser les deux vis des éléments d'affichage.



03.12. Retirer les éléments d'affichage.



03.13. Fermer les deux trous depuis l'intérieur à l'aide de bouchons.

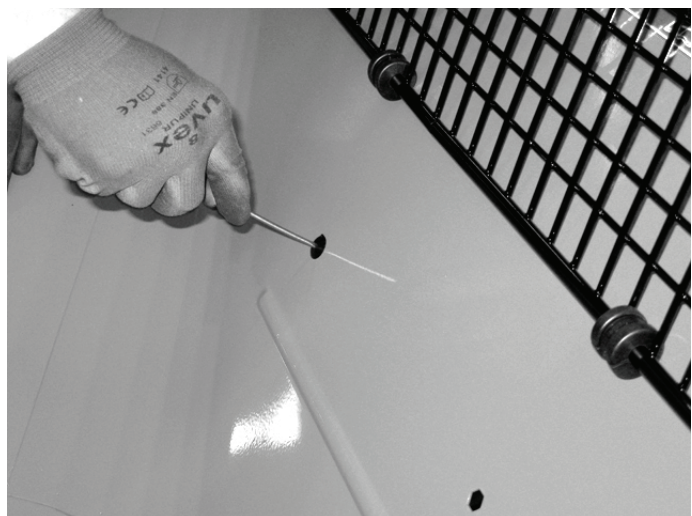



03.14. Fermer la grille de protection et la verrouiller.

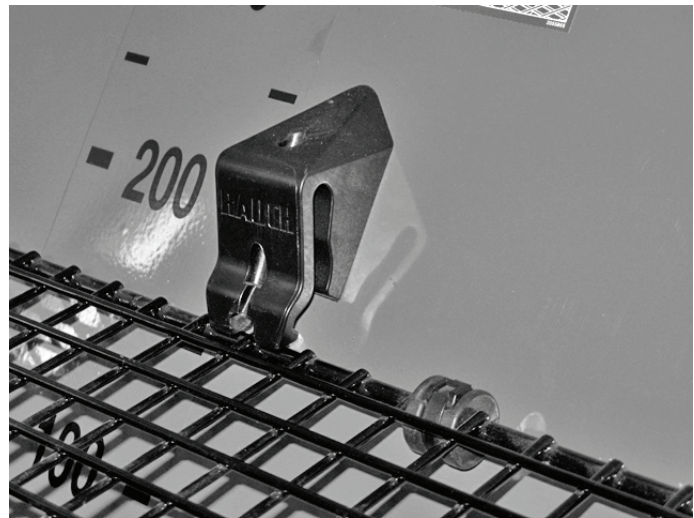



#### 04. Vérifier le réglage du secteur gradué

*Conditions requises :*

*Afin de vérifier le réglage des vannes de dosage, la mécanique doit pouvoir bouger librement.*

*Le ressort de rappel est retiré.*

*Le cylindre hydraulique est retiré.*

- 04.1. Positionner le levier sur la valeur « 130 » et le fixer avec la poignée en T.

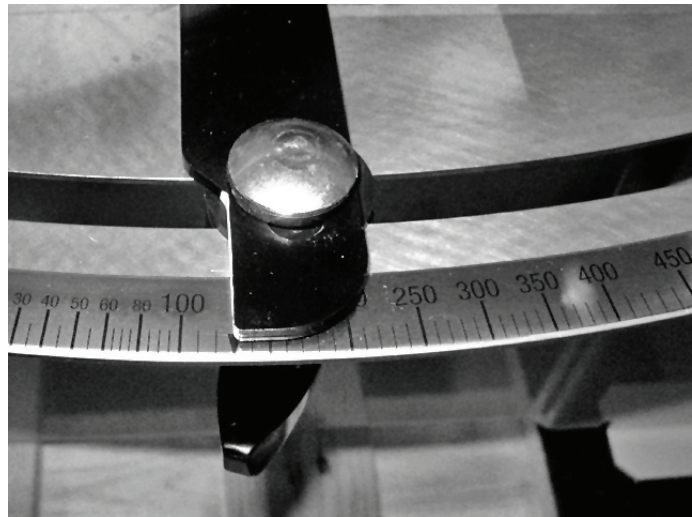

- 04.2. Tirer la vanne de dosage à la **main** vers la butée correspondante.





04.3. Placer un axe de Ø 28 mm dans l'ouverture.

*Vous pouvez pour cela utiliser un axe de bras inférieur du MDS.*

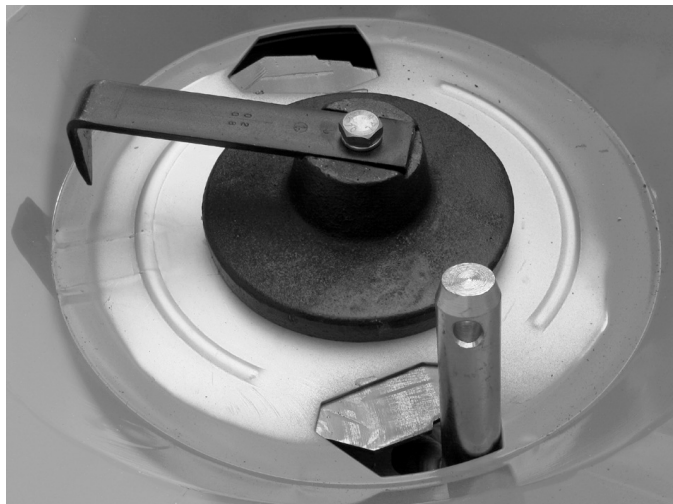

04.4. **Vérifier** : Une fois l'axe dans l'ouverture, il ne doit pas y avoir de jeu.

*Si cela n'est pas le cas, vous trouverez des informations complémentaires dans la notice d'instructions du MDS, au chapitre « Vérifier et régler la vanne de dosage ».*

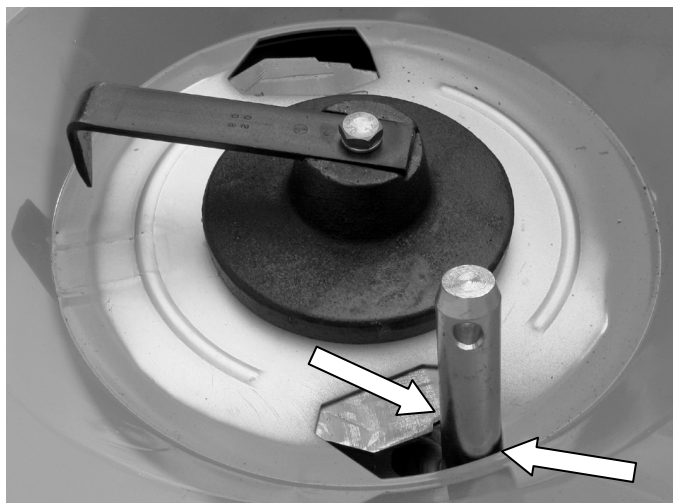

04.5. Retirer l'axe.

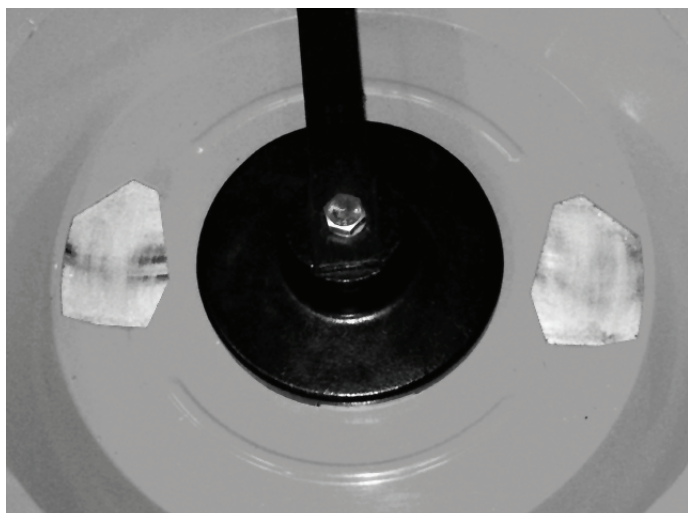



04.6. Retirer la poignée en T



04.7. Répéter les étapes 1 à 6 pour la vanne de dosage droite.

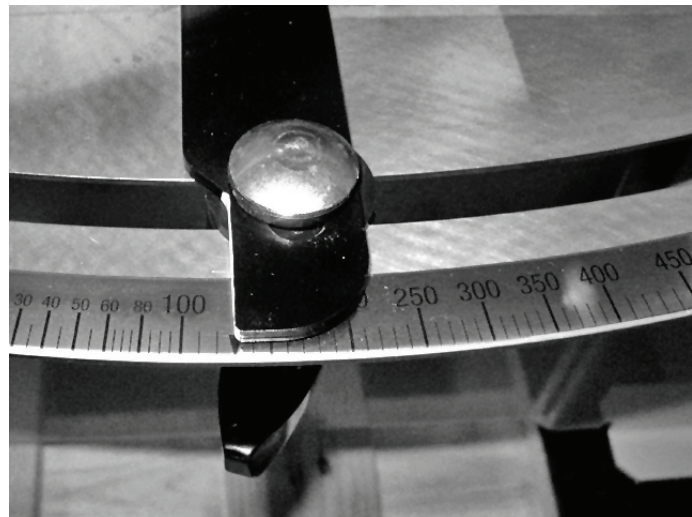

*Vous trouverez de plus amples informations dans la notice d'instructions MDS.*



## 05. Monter le vérin

- 05.1. Visser le boîtier de commande par dessous à la console centrale.

Couple de serrage :  $\approx 7 \text{ Nm}$

### Légende

- a) Rondelles 6,4 x 12,5 x 1,6
- b) Vis à tête plate et ronde ou vis à collerette M6 x 20
- c) Écrou M6

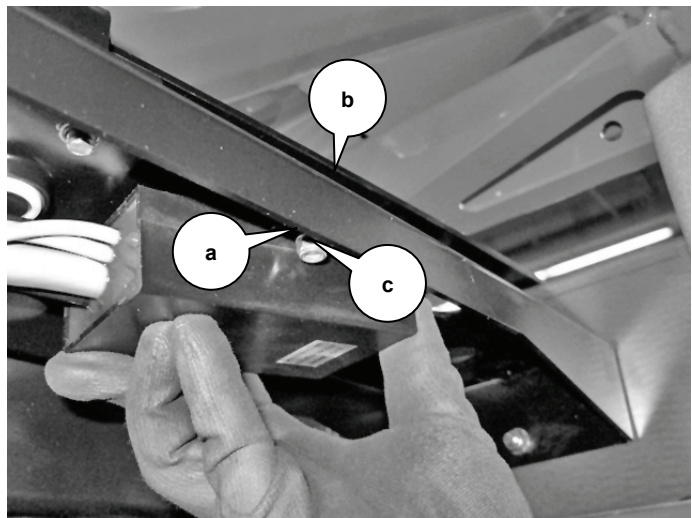

- 05.2. Sur la console dévisser la vis à tête bombée placée à droite dans le sens d'avancement.

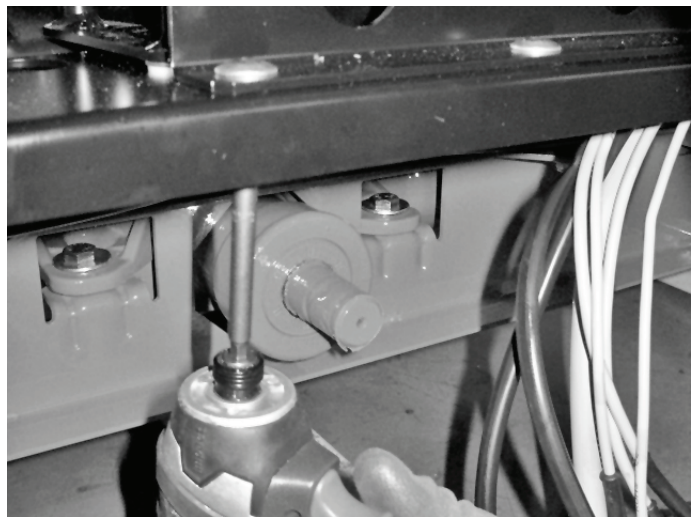

- 05.3. Replier le collier de fixation sur lui-même.

### Légende

- a) Collier de fixation  $\varnothing 13$ , B20
- b) Vis ronde à tête bombée M8 x 25

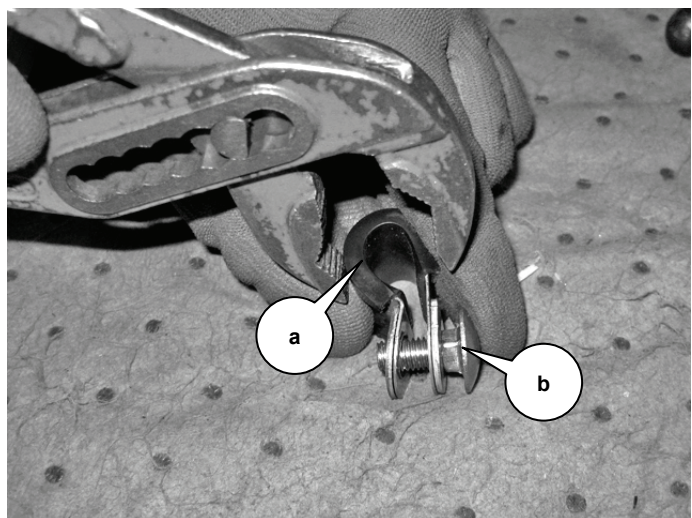



- 05.4. Poser le câble et visser le collier de fixation.  
Couple de serrage : **15 Nm**

**Légende**

- a) Rondelle 17 x 8,4 x 1,6  
b) Écrou M8

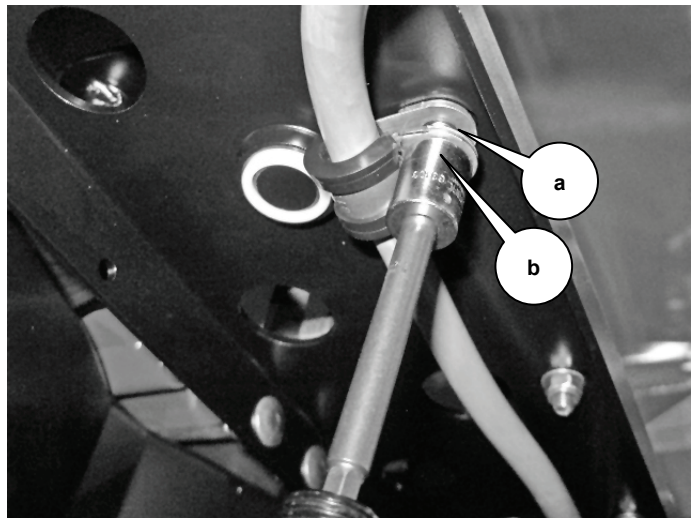

- 05.5. Placer les boulons d'appui droit et gauche dans le trou oblong correspondant.

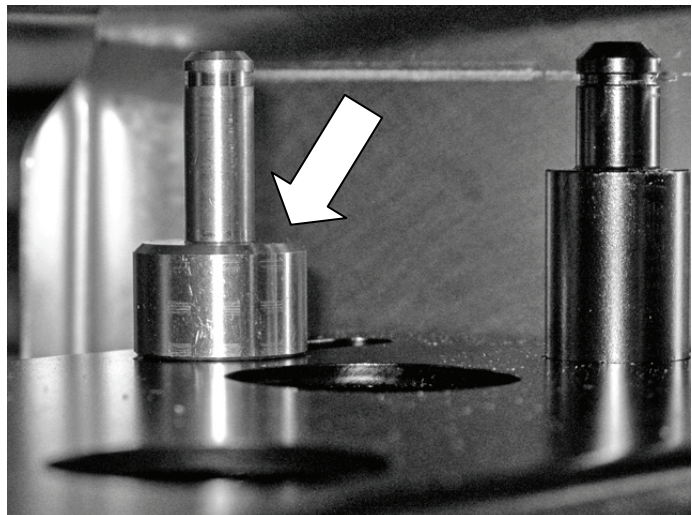

- 05.6. Fixer à la main une rondelle et un écrou hexagonal en dessous.

**Légende**

- a) Écrou M10  
b) Rondelle 10,5 x 30 x 2,5

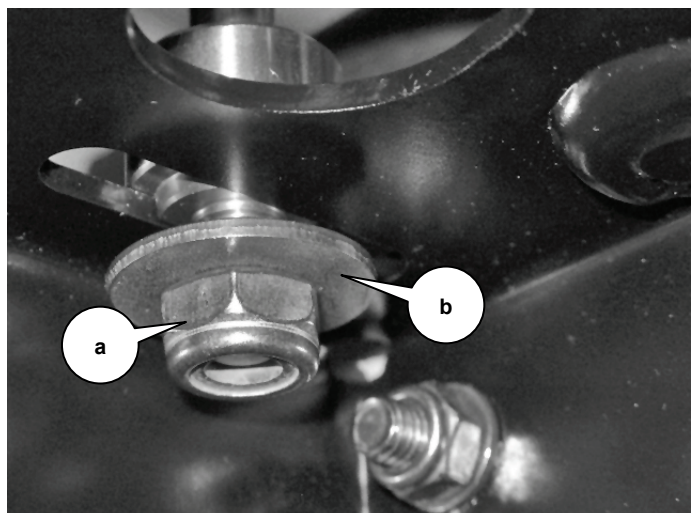





- 05.7. Visser la bielle jusqu'à la butée.  
*Pour cela, tourner la bielle dans le sens des aiguilles d'une montre.*



- 05.8. Puis tourner la bielle d'un demi-tour en sens inverse.  
*Ainsi la bielle ne se trouve plus sur la fin de course du vérin.*

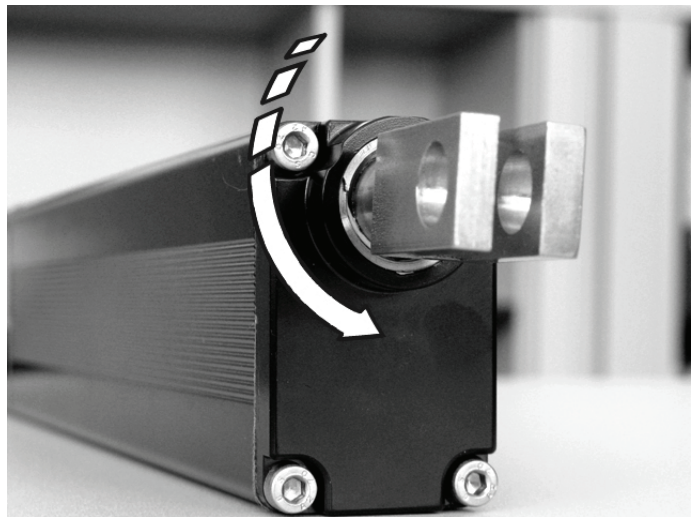

- 05.9. Installer les vérins sur les deux côtés et les fixer chacun avec une rondelle de sécurité.  
*Passer le câble en dessous.*

**Légende**

- a) Vérin  
b) Rondelle de sécurité

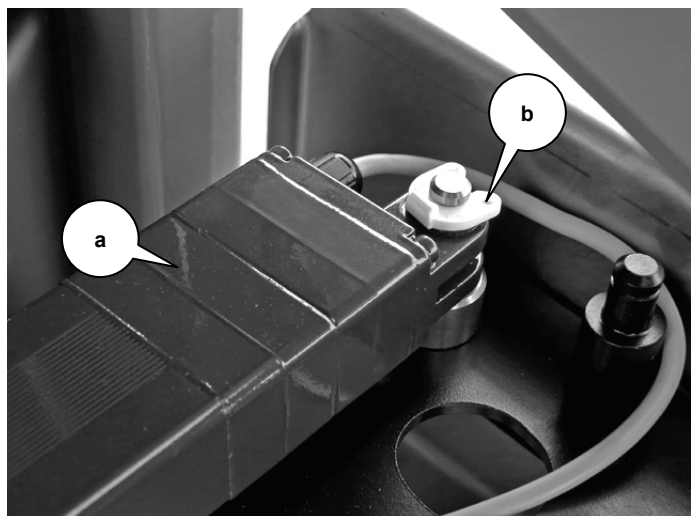



05.10. Pousser les deux vérins vers l'intérieur contre la butée.

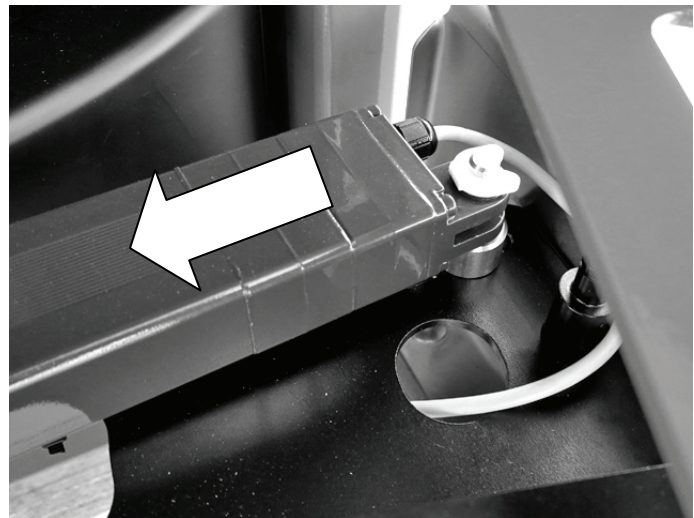



## 06. Poser le câble / brancher les vérins

06.1. Fixer le câble sous la console à l'aide d'un attache-câbles.



06.2. Brancher les vérins au boîtier de commande **conformément** au **marquage**.





- 06.3. Fixer le câble du vérin à l'aide d'attache-câble, à **distance suffisante** de la fiche.



- 06.4. Attacher ensemble avec des attache-câbles toutes les fiches inutilisées.





## 07. Connecter les vérins et vannes

- 07.1. Inspecter les boulons épaule.  
*Les boulons épaule doivent entrer dans les pièces de guidage.*



- 07.2. **Uniquement si un boulon ne passe pas :**  
Élimer le trou de la pièce de guidage.

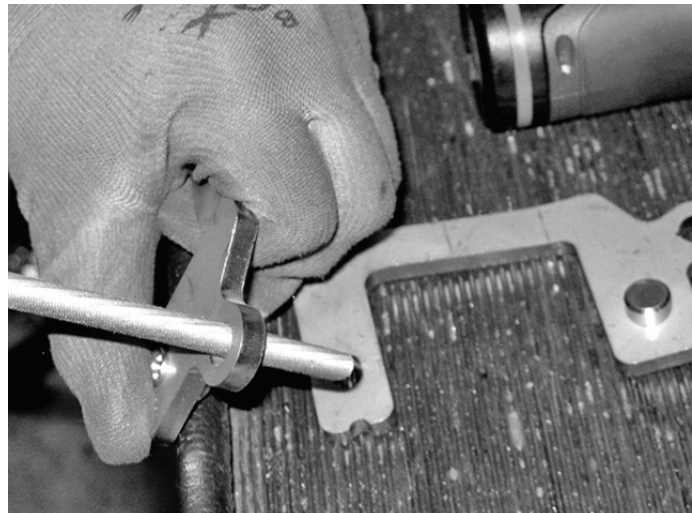

- 07.3. Disposer les vannes de dosage au centre.

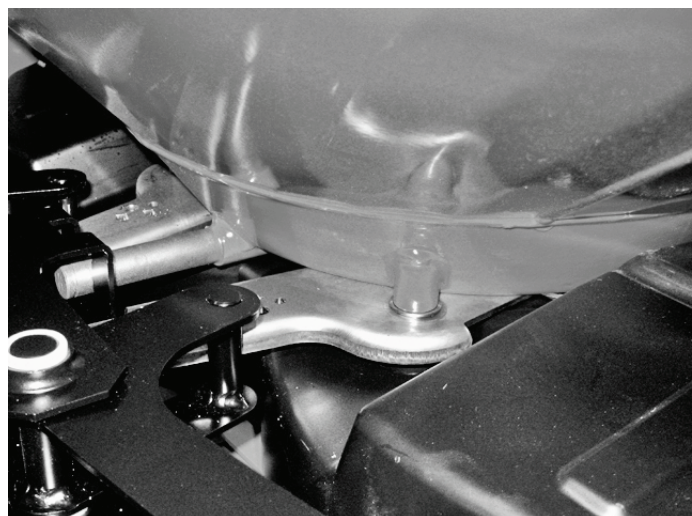



- 07.4. **Installer** le levier au niveau de la vanne de dosage correspondante.  
*Il ne doit **pas y avoir de jeu** entre les deux composants.*



- 07.5. Relier la pièce de guidage avec la vanne  
*Il ne doit **pas y avoir de jeu** entre la pièce de guidage, le levier et la vanne de dosage.*

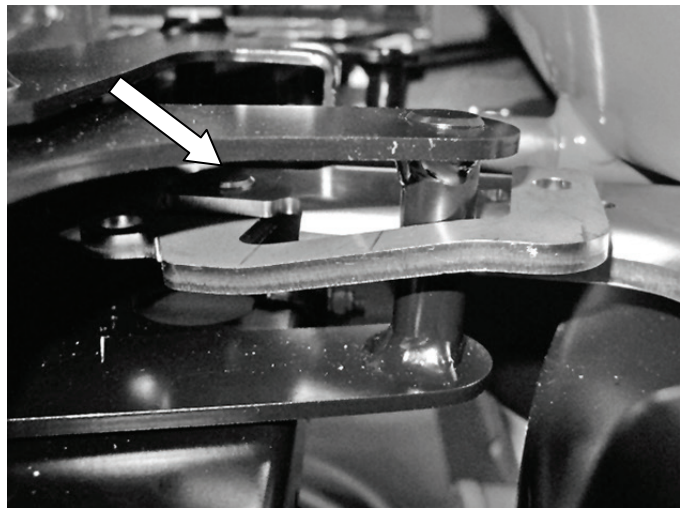

- 07.6. Visser les deux pièces de guidage avec les vannes de dosage.  
Couple de serrage : **15 Nm**

**Légende**

- a) Vis à six pans M8 x 25
- b) Rondelles 17 x 8,4 x 1,6
- c) Écrou hexagonal M8

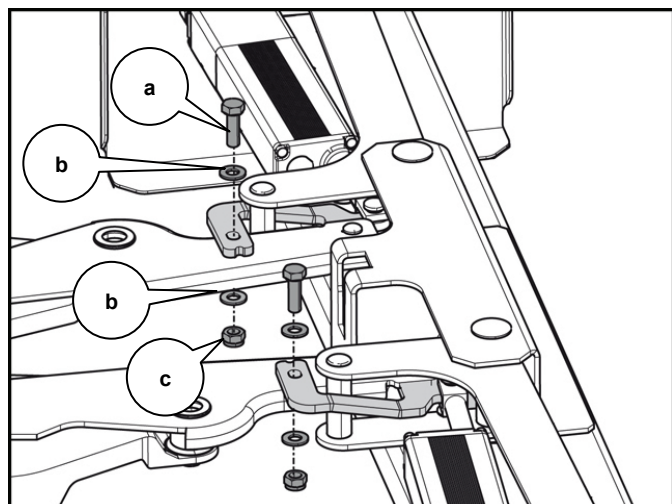



07.7. Graisser les pièces de guidage.



07.8. Relier les vérins aux pièces de guidage.

**Légende**

a) Boulons épaupe

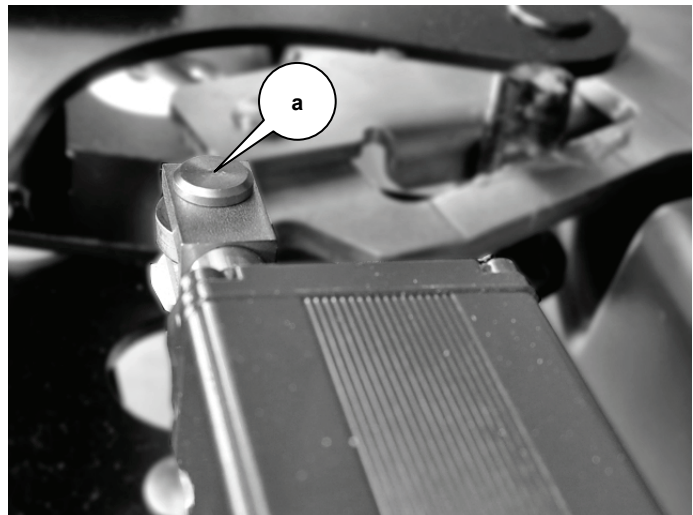

07.9. Fixer fermement les deux boulons.  
Distance min. de 4 mm entre le bord inférieur du boulon épaupe et du levier de butée.

*En cas contraire, le boulon épaupe peut se coincer avec le levier de butée.*

**Légende**

a) Boulons épaupe

b) Rondelle de sécurité

c) Levier de butée

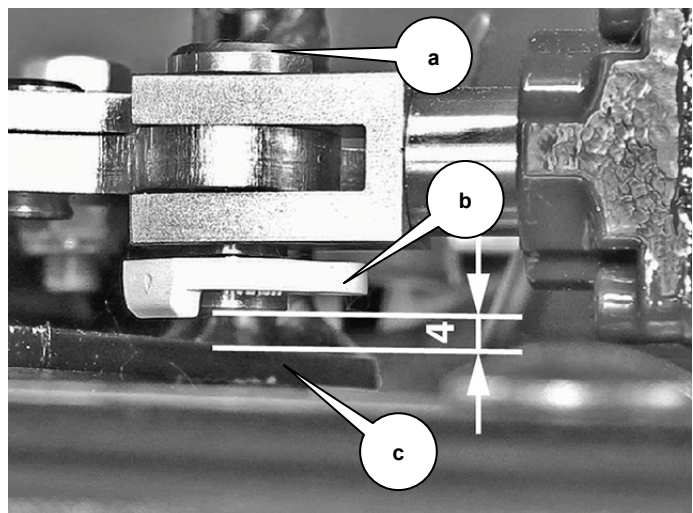



07.10. Relier les boulons au secteur gradué.

**Légende**

- a) Boulons
- b) Rondelle POM 13 x 40 x 3
- c) Rondelle POM 13,5 x 30 x 2,5

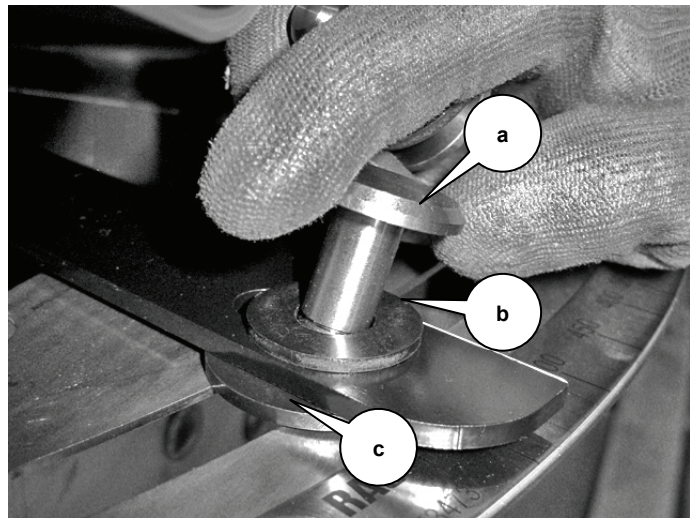

07.11. Fixer fermement le boulon épaule.

**Légende**

- a) Rondelle POM 13,5 x 30 x 2,5
- b) Rondelle POM 13 x 40 x 3
- c) Rondelle 13 x 24 x 2,5
- d) Rondelle de sécurité

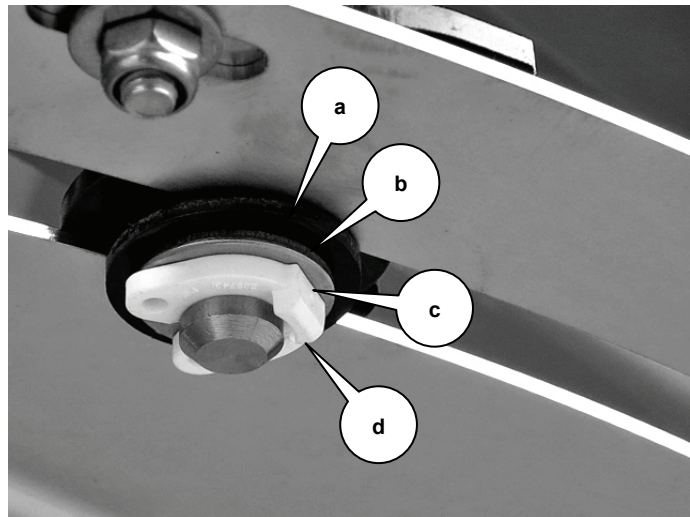

07.12. Pousser les vérins vers l'extérieur jusqu'à ce que le levier de butée se trouve à une demi-graduation environ au-dessus de 550 (flèche).







07.13. Fixer l'écrou au boulon d'appui.  
Couple de serrage :  $\approx 30$  Nm

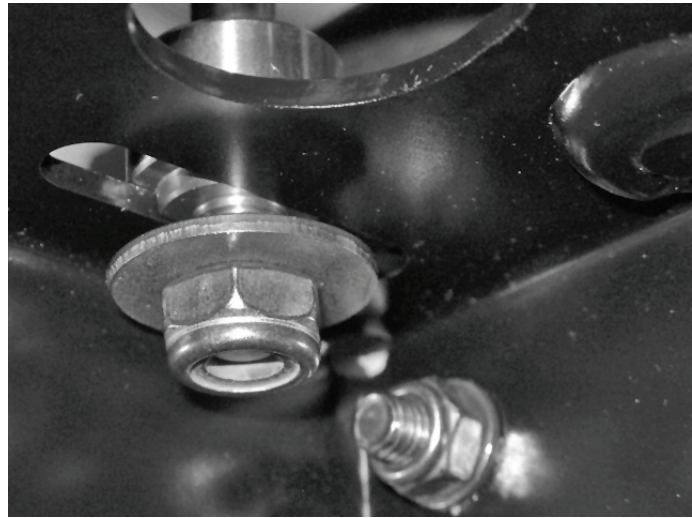



## 08. QUANTRON-A

- 08.1. Visser fermement l'une des tôles de fixation pour le QUANTRON-A.

### Légende

- a) Vis à tête bombée M5 x 10

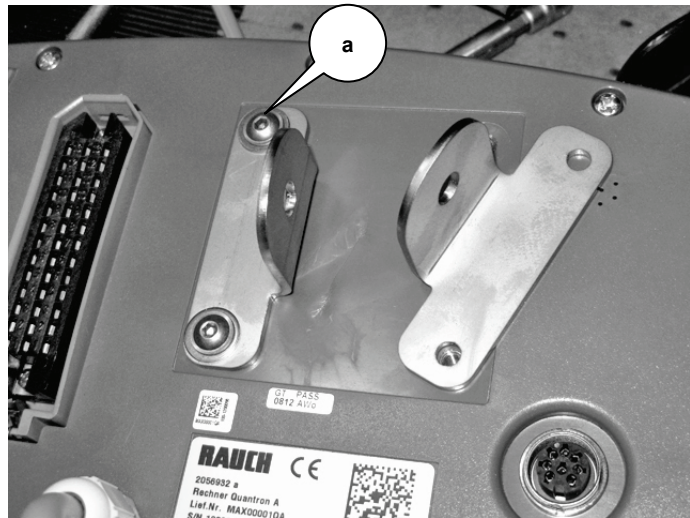

- 08.2. Placer le support avec une vis sur la tôle de fixation.

### Légende

- a) Rondelle 8,4 x 24 x 2

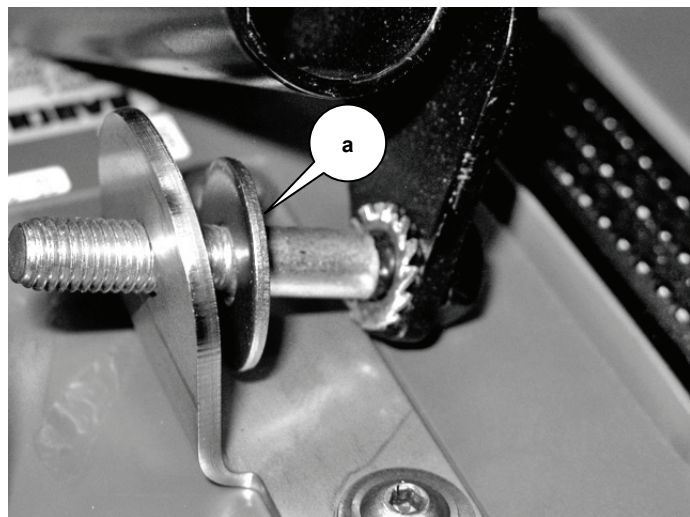

- 08.3. Installer et monter sans la serrer la bague d'entretoise et la deuxième tôle de fixation.

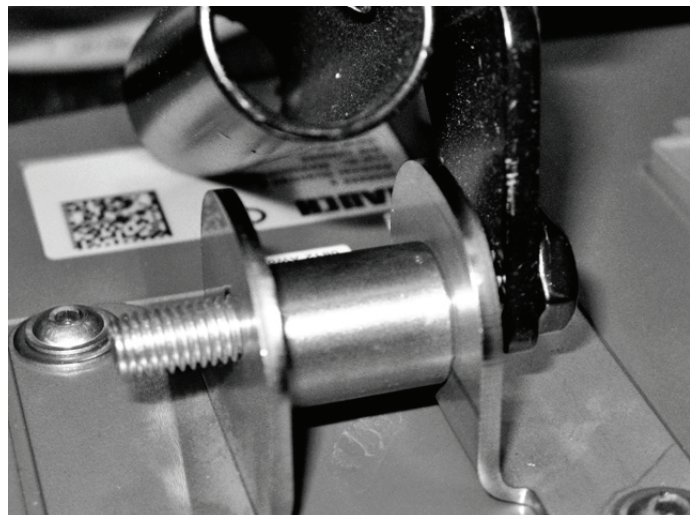



08.4. Installer l'écrou et le visser fermement.

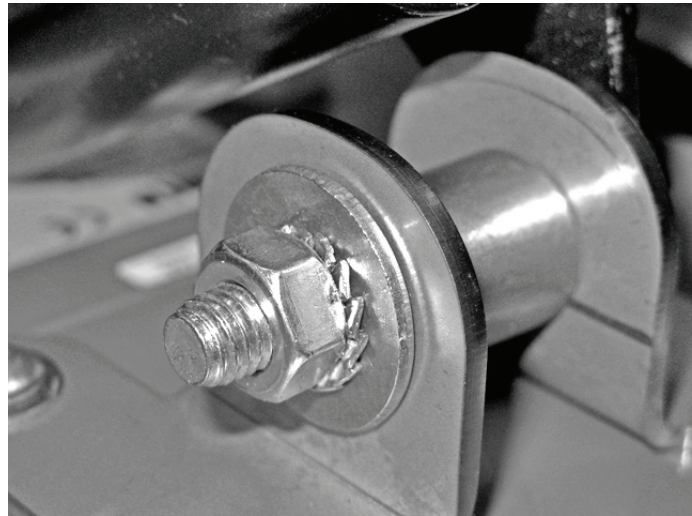

08.5. Visser la vis à collerette de la deuxième tôle.

**Légende**

a) *Vis à tête bombée M5 x 10*

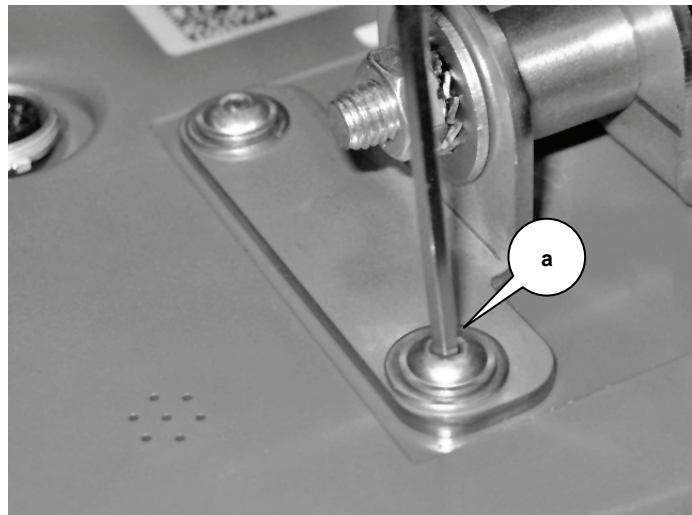



## 09. Calibrer QUANTRON-A

**⚠ DANGER !**



**La vanne de dosage est actionnée par commande externe**

Danger de coincement et de cisaillement, vous risquez de perdre un membre !

- ▶ Maintenir la grille de protection fermée.
- ▶ Maintenir une distance suffisante avec tous les éléments mobiles du distributeur.
- ▶ Respecter la notice d'instructions du distributeur, en particulier le chapitre « Sécurité ».

### 09.1. Raccorder QUANTRON-A au distributeur.

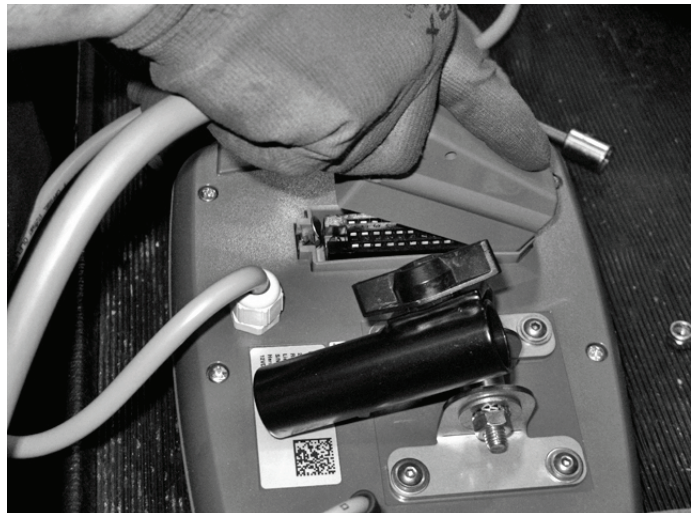

### 09.2. Relier QUANTRON-A à l'alimentation électrique.

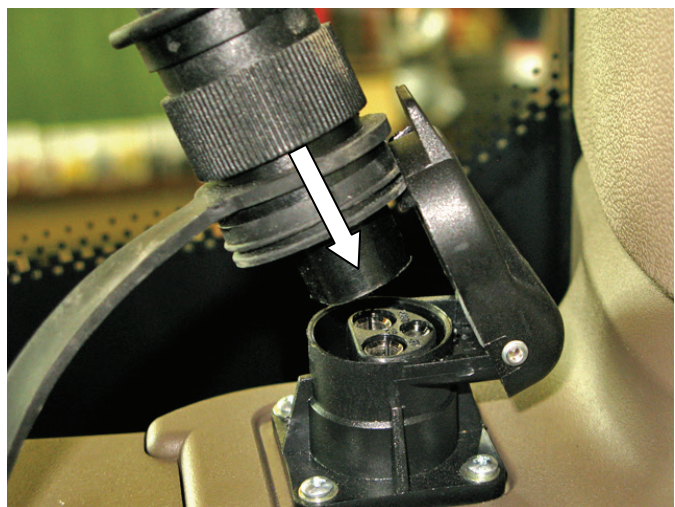



09.3. Allumer QUANTRON-A.



09.4. Appuyer sur la touche **Menu**.

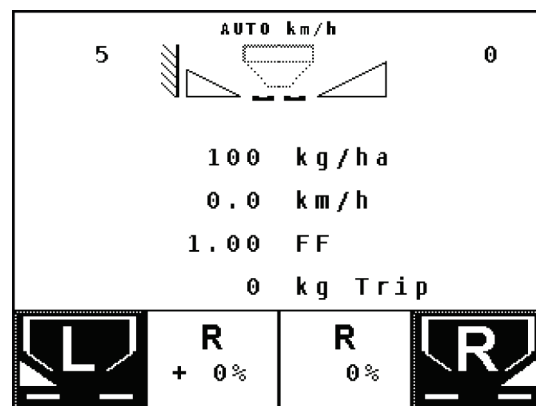

09.5. Sélectionner successivement **System / Test > Service** et confirmer avec la touche **ENTER**.

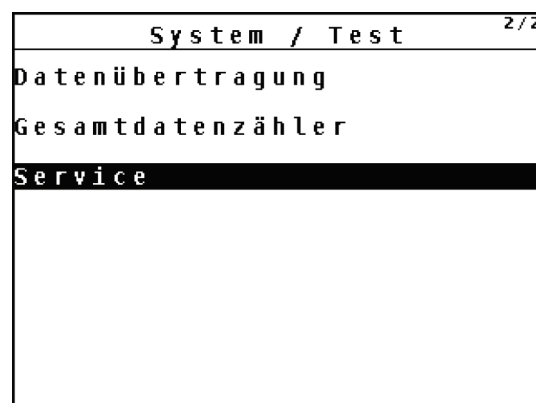



- 09.6. Saisir le code **3354** avec les **touches-flèches** et confirmer avec **ENTER**.

Freigabecode
<b>3354</b>

- 09.7. Sélectionner successivement **Options machine > Secteur max.** et confirmer avec **ENTER**.

Maschinenoptionen	1/3
Leermelder	✓
Telimitsensoren	✓
Aktuator	RH03
<b>Skala max</b>	<b>410</b>
Wiegezellen	
MHC	
AGP	

- 09.8. Appuyer plusieurs fois sur **ENTER** et choisir la valeur maximale « **550** ».

Maschinenoptionen	1/3
Leermelder	✓
Telimitsensoren	✓
Aktuator	RH03
<b>Skala max</b>	<b>550</b>
Wiegezellen	
MHC	
AGP	



09.9. Accéder au **Service**, appuyer pour cela plusieurs fois sur **ESC**.



09.10. Choisir **Calibrage vérins** et appuyez sur **ENTER**.

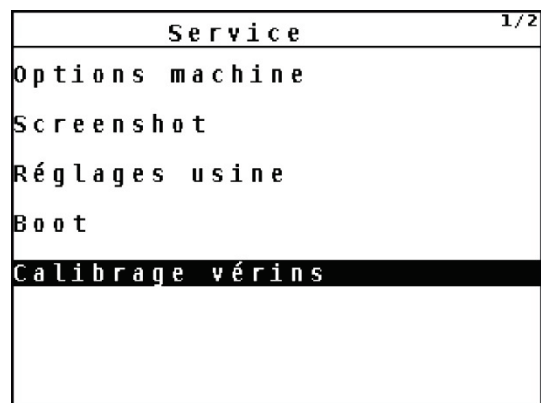

09.11. Amener **la vanne droite** à l'aide des **touches fonction** vers la butée inférieure.

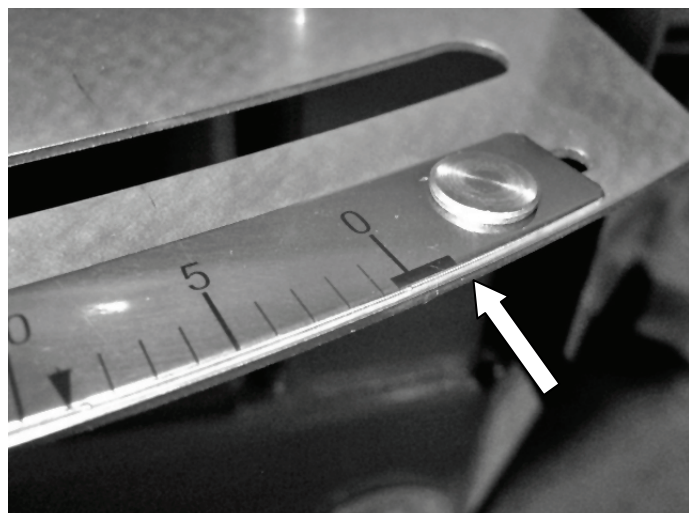



09.12. Positionner la **vanne droite** avec les **touches de fonction** sur la valeur « 0 » et appuyer sur **ENTER**.

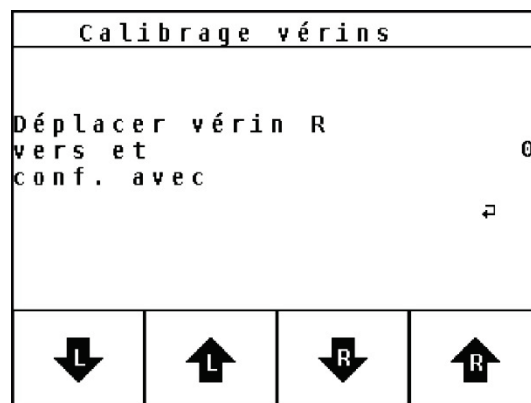

09.13. Positionner la **vanne droite** à l'aide des **touches de fonction** sur **130** et appuyez sur **ENTER**.

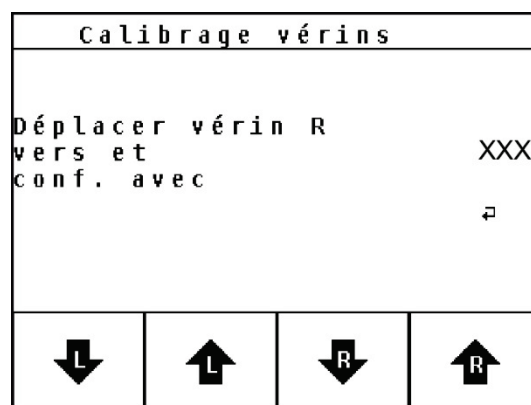

09.14. Positionner la **vanne droite** à l'aide des **touches de fonction** sur **550** et appuyez sur **ENTER**.

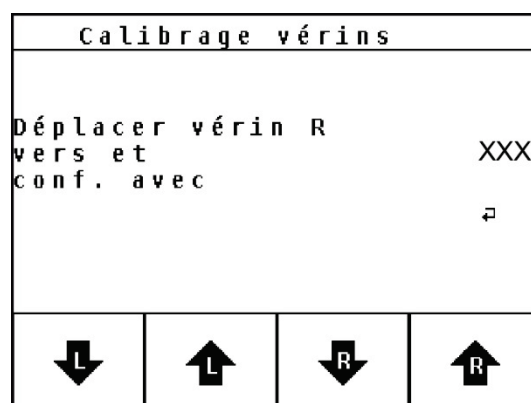





09.15. Positionner la **vanne droite** avec les **touches de fonction** sur une valeur entre « 0 » et la butée inférieure.

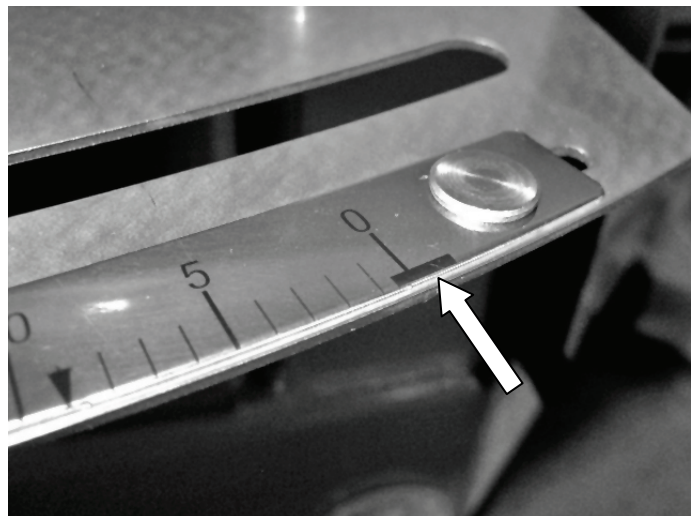
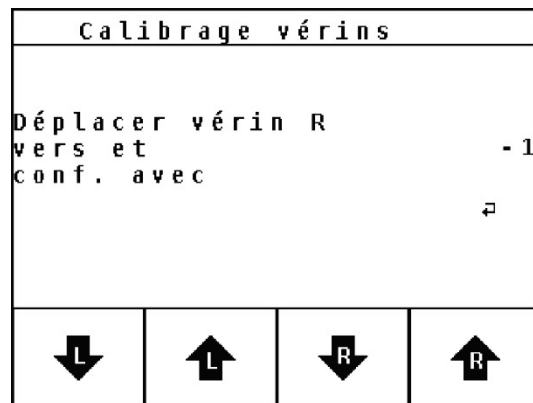

09.16. Effectuer une vérification **visuelle** : La vanne droite doit maintenant être complètement fermée.  
*Si la vanne est encore ouverte, vous trouverez de plus amples informations au chapitre 10 « Si lors du calibrage, une vanne était partiellement ouverte »*

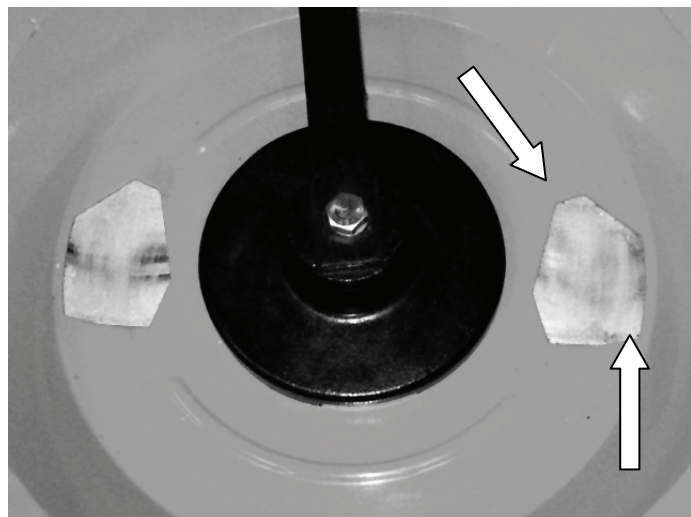



09.17. Appuyer sur **ENTER**.

Calibrage vérins			
Déplacer vérin R vers et conf. avec			- 1 ↵
↓	↑	↓	↑

09.18. Positionner la **vanne gauche** avec les **touches de fonction** sur la valeur « 0 » et appuyer sur **ENTER**.

Calibrage vérins			
Déplacer vérin L vers et conf. avec			0 ↵
↓	↑	↓	↑

09.19. Positionner la **vanne gauche** à l'aide des **touches de fonction** sur **130** et appuyez sur **ENTER**.

Calibrage vérins			
Déplacer vérin L vers et conf. avec			XXX ↵
↓	↑	↓	↑



09.20. Positionner la **vanne gauche** à l'aide des **touches de fonction** sur **550** et appuyez sur **ENTER**.

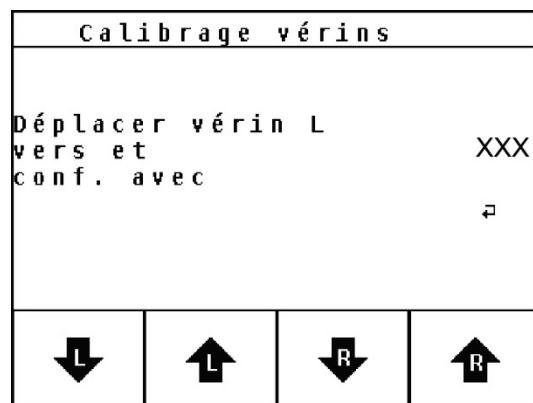

09.21. Positionner la **vanne gauche** avec les **touches de fonction** sur une valeur entre « 0 » et la butée inférieure.

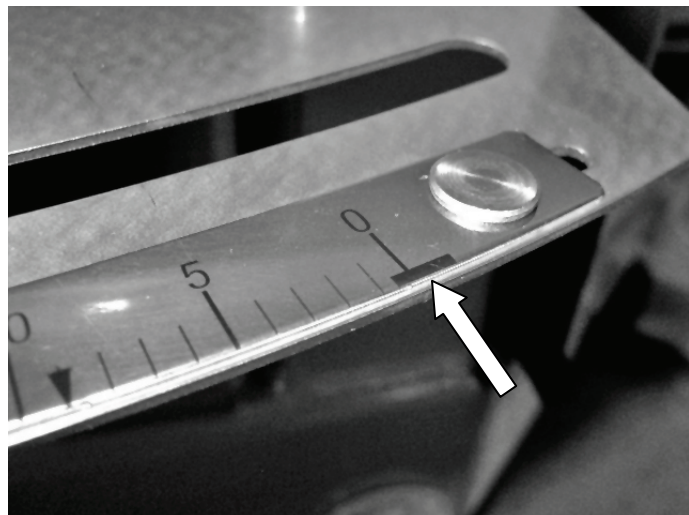
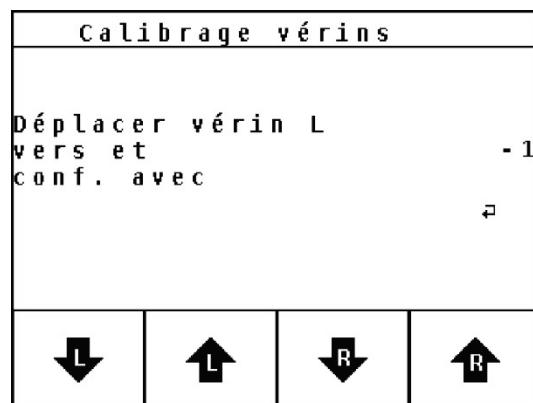



09.22. Effectuer une vérification **visuelle** : La vanne gauche doit maintenant être complètement fermée.  
*Si la vanne est encore ouverte, vous trouverez de plus amples informations au chapitre 10 « Si lors du calibrage, une vanne était partiellement ouverte »*

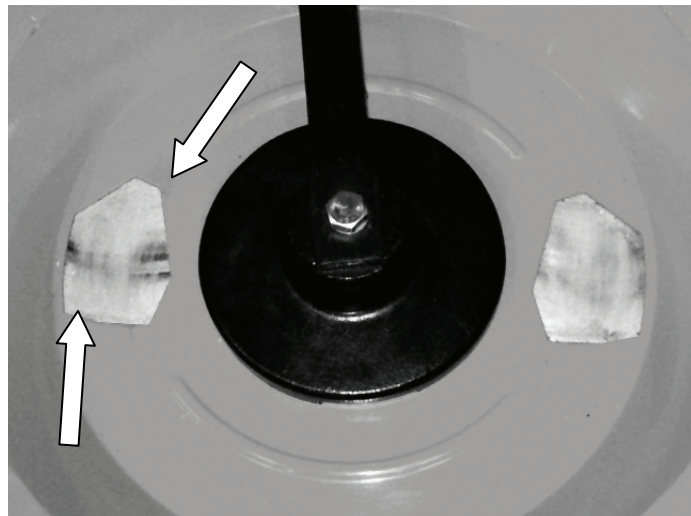

09.23. Appuyer sur **ENTER**.

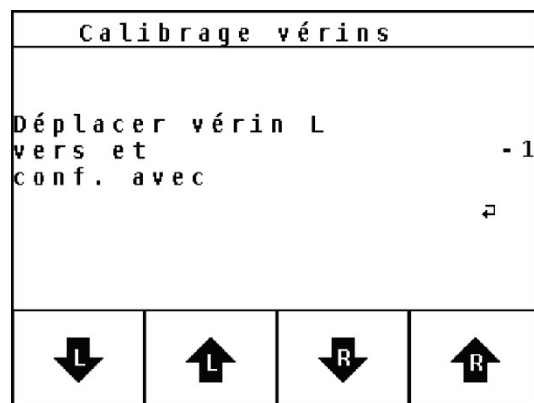

09.24. Accéder à l'écran de travail, appuyer pour cela plusieurs fois sur **ESC**.





## 10. Si lors du calibrage, une vanne était partiellement ouverte

### ⚠ DANGER !



#### **La vanne de dosage est actionnée par commande externe**

Danger de coincement et de cisaillement, vous risquez de perdre un membre !

- ▶ Éteindre le moteur du tracteur ou de l'appareil hydraulique.
- ▶ Retirer la clé du contact.
- ▶ Éteindre QUANTRON-A et le déconnecter du distributeur
- ▶ Arrêter le distributeur conformément à la notice d'instructions.
- ▶ Déconnecter le distributeur complètement du tracteur ou du groupe hydraulique.
- ▶ Respecter la notice d'instructions du distributeur, en particulier le chapitre « Sécurité ».

### 10.1. Desserrer l'écrou des boulons d'appui.





10.2. Décaler le cylindre.

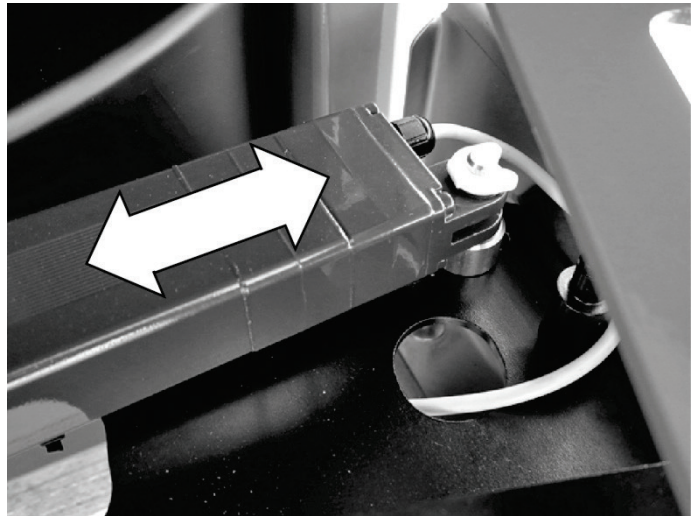

10.3. Fixer l'écrou au boulon d'appui.  
Couple de serrage :  $\approx 30$  Nm



10.4. Répéter le calibrage  
(voir chapitre 09)





## 11. Contrôler le calibrage

**⚠ DANGER !**



**La vanne de dosage est actionnée par commande externe**

Danger de coincement et de cisaillement, vous risquez de perdre un membre !

- ▶ Maintenir la grille de protection **fermée**.
- ▶ **Maintenir une distance suffisante** avec tous les éléments mobiles du distributeur.
- ▶ Respecter la notice d'instructions du distributeur, en particulier le chapitre « Sécurité ».

### 11.1. Raccorder QUANTRON-A au distributeur.

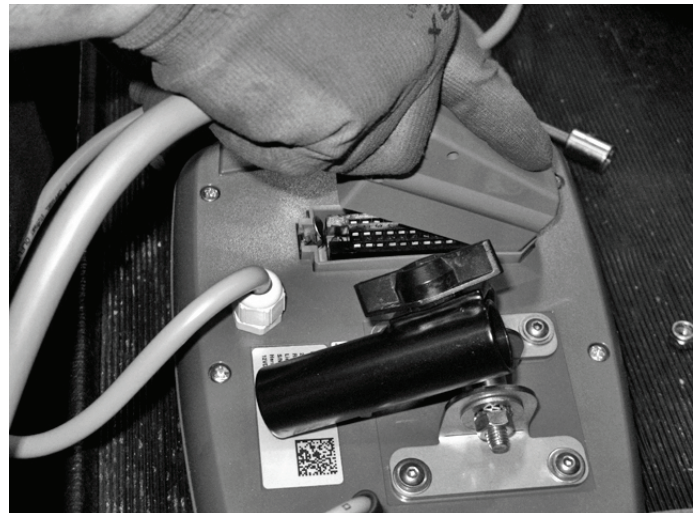

### 11.2. Relier QUANTRON-A à l'alimentation électrique.





11.3. Appuyer sur la touche **Menu**.

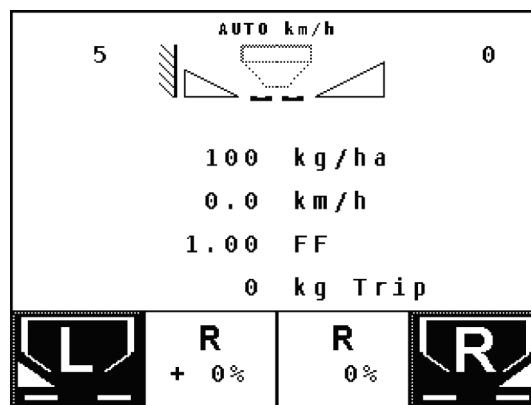

11.4. Sélectionner successivement **Système / Test > Test / Diagnostic > Vérifier pos secteur** et confirmer avec la touche **ENTER**.

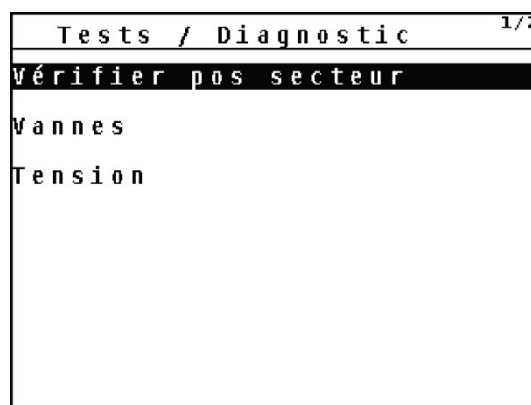

11.5. Amener les vérins aux points de test, contrôler des deux côtés et confirmer.

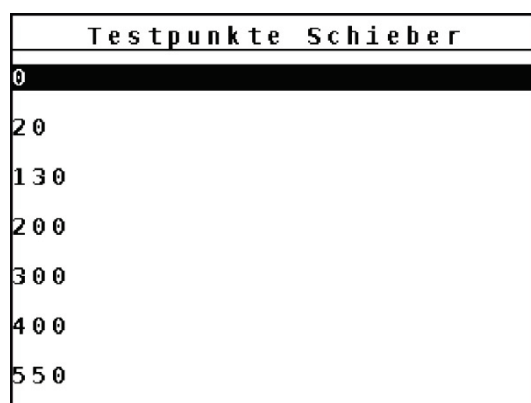





- 11.6. Accéder à l'écran de travail, appuyer pour cela plusieurs fois sur **ESC**.





## 12. Régler QUANTRON-A

### ⚠ DANGER !



#### La vanne de dosage est actionnée par commande externe

Danger de coincement et de cisaillement, vous risquez de perdre un membre !

- ▶ Maintenir la grille de protection **fermée**.
- ▶ **Maintenir une distance suffisante** avec tous les éléments mobiles du distributeur.
- ▶ Respecter la notice d'instructions du distributeur, en particulier le chapitre « Sécurité ».

Les réglages indiqués dans ce chapitre ne sont possibles que si vous avez mis QUANTRON-A en mode « Expert ».

Vous trouverez de plus amples informations dans la notice d'instructions du QUANTRON-A.

### 12.1. Appuyer sur **Menu**

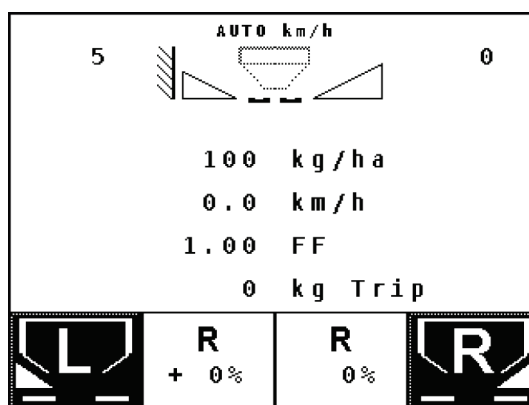

### 12.2. Sélectionner successivement **Réglages engrais > Type de disques**, et appuyer ensuite sur **ENTER**.

Réglages engrais <span style="float: right;">2/3</span>	
<b>Type de disques</b>	
Prise de force	540
Type épand. lim. R.O.E.	
Telimat R.O.E.	-----
Type d'épand.	normal
Hauteur attel.	50/50



12.3. Choisir le type de disque monté et appuyer sur **ENTER**.

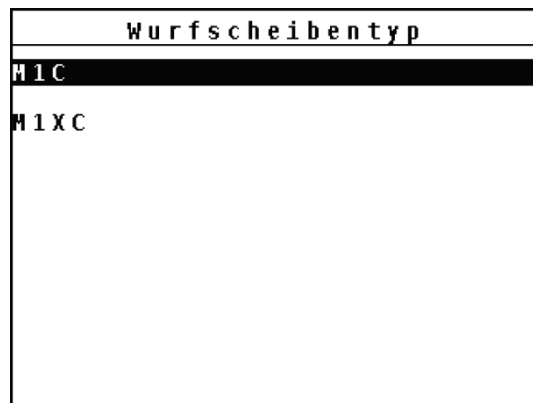

12.4. Accéder à l'écran de travail, appuyer pour cela plusieurs fois sur **ESC**.



12.5. Appuyer sur **Menu**

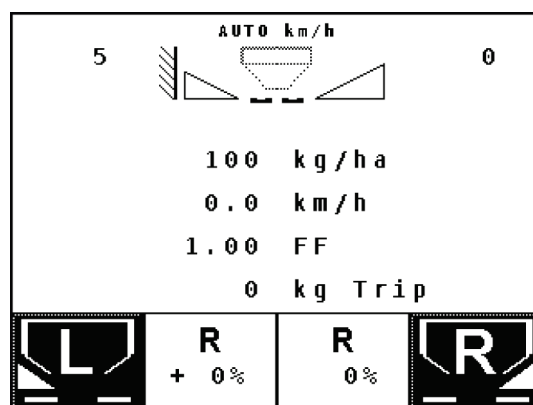



12.6. Choisir **Vidage rapide** et appuyez sur **ENTER**.

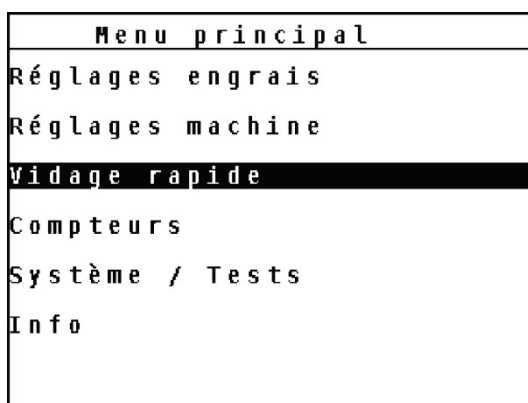

12.7. Choisir les deux côtés avec les touches de fonction.

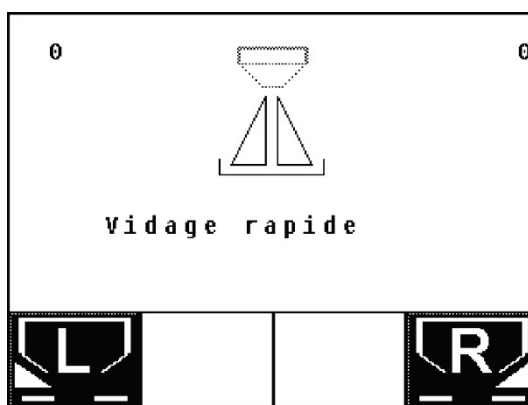

12.8. Appuyer sur **Start**.





12.9. Éteindre QUANTRON-A.



12.10. Couper QUANTRON-A de l'alimentation électrique et du distributeur.

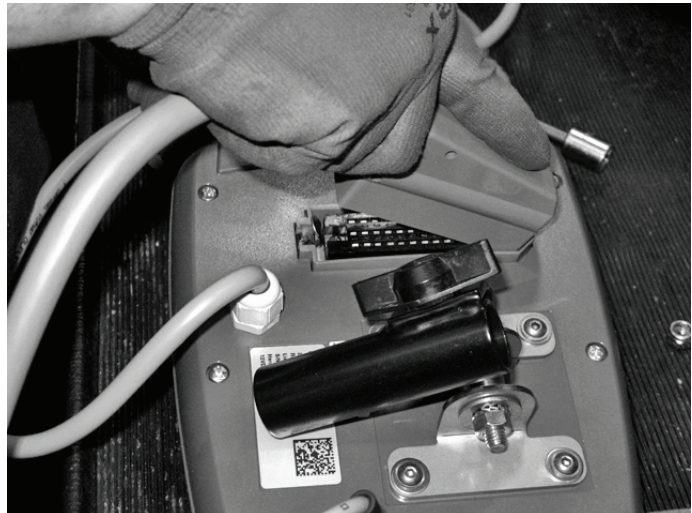



## ATTENTION

### **Dommages occasionnés par l'eau et la saleté**

L'eau et la saleté endommagent le connecteur

- ▶ Orienter le coté ouvert du connecteur vers le.

12.11. Ranger le câble machine.

