

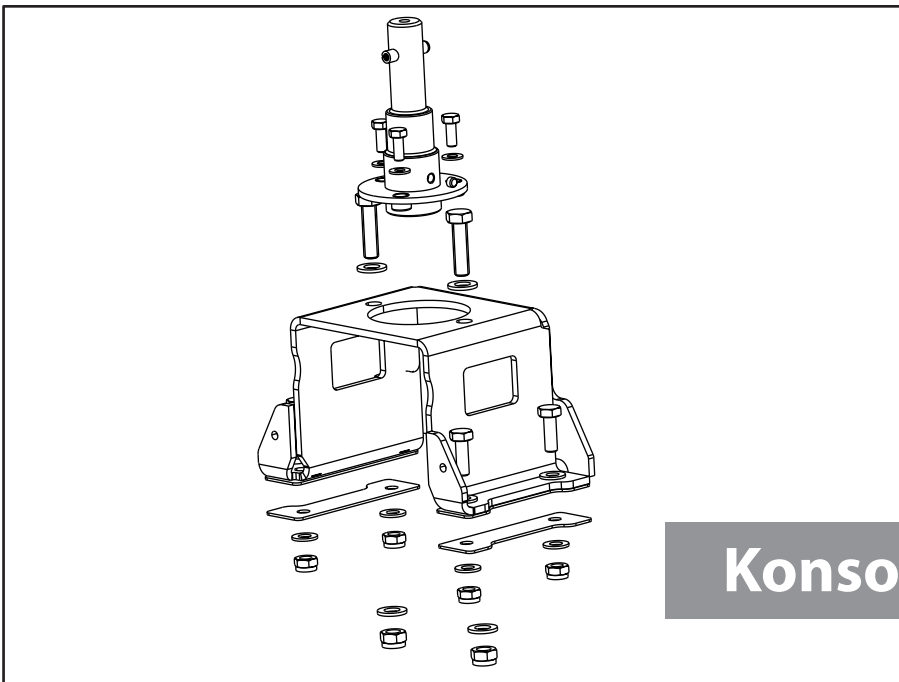

AXEO H/HC



Konsole





Wichtig

de

Sicherheits- und Unfallverhütungsvorschriften

Vor etwaigen Einstell- oder sonstigen Arbeiten z.B. Reinigung, Wartung, Umbau oder Anbau **Zapfwelle ausschalten, Motor abstellen und Zündschlüssel abziehen.**

Beachten Sie auch die Sicherheitshinweise in der Betriebsanleitung zu diesem Zubehör!



Important

en

Accident prevention and safety regulations

Always disconnect the PTO (power take-off) , shut down the engine and remove the ignition key before carrying out any adjustments or other work on the machine (e.g. cleaning, maintenance, additions or modifications).

Refer also to the safety instructions in the user manual provided with the fittings.



Important

fr

Consignes de sécurité et de prévention des accidents

Avant d'éventuels travaux de réglage ou autres, par exemple nettoyage, entretien, transformation ou ajout, **désactiver la prise de force, arrêter le moteur et retirer la clé de contact.**

Respecter également les consignes de sécurité figurant dans le manuel d'utilisation de cet accessoire !



Importante

it

Norme di sicurezza e antinfortunistiche

Prima di qualsiasi intervento di regolazione o lavoro, ad es. pulizia, manutenzione, modifica o montaggio

disinserire la presa di forza, spegnere il motore ed estrarre la chiave dell'accensione.

Rispettare anche le norme di sicurezza contenute nel manuale d'uso di questo accessorio!



Belangrijk

nl

Veiligheids- en ongevalpreventievoorschriften

Voor alle instel- of andere werkzaamheden, bijv. reiniging, onderhoud, ombouwen of aanbouwen **de aftakas uitschakelen, de motor uitzetten en de contactsleutel uit het contactslot trekken.**

Neem ook de veiligheidsinstructies in de bedieningshandleiding ten aanzien van dit accessoire in acht!



Viktigt

sv

Föreskrifter om säkerhet och olycksförebyggande åtgärder

Före inställningar eller andra arbete som t.ex. rengöring, underhåll, ombyggnad eller montering **Stäng av kraftuttaget och motorn samt ta ut tändningsnyckeln.**

Beakta även säkerhetsinformationen i bruksanvisningen för de aktuella tillbehören!



Importante

es

Normativa para la seguridad y prevención de accidentes

Previo a las labores de ajuste o de cualquier otro tipo como, p. ej., limpieza, mantenimiento, modificación o montaje,

desacople el eje de toma de fuerza, apague el motor y extraiga la llave de encendido.

¡Observe asimismo las indicaciones de seguridad contenidas en el manual de instrucciones de este accesorio!



Fontos

hu

Biztonsági és balesetvédelmi előírások

A gép beállítása vagy egyéb munkálatai előtt (pl. tisztítás, karbantartás, átépítés vagy felszerelés) **kapcsolja ki az erőleadó tengelyt, állítsa le a motort és húzza ki a gyújtáskulcsot.**

Ügyeljen a tartozék kezelési útmutatójában található biztonsági tudnivalók betartására.



Viktig

no

Sikkerhets- og ulykkesforebyggende forskrifter

Før eventuelle innstillings- eller andre arbeider som f.eks. rengjøring, vedlikehold, ombygging eller påbygging:

Koble ut tappakselen, slå av motoren og trekk ut tenningsnøkkelen.

Følg også sikkerhetsanvisningene i bruksanvisningen for dette tilbehøret!



Tärkeätä

fi

Turvallisuusmääräykset

Voimanottoakseli on kytkettävä irti, moottori sammutettava ja virta-avain vedettävä irti virtalukosta ennen kaikkia säätö- tai muita toimia kuten esim. puhdistusta, huoltoa, muutostöitä tai lisälaitteiden kytkemistä.

Noudata myös lisävarusteiden käyttöohjeissa olevia turvallisuuteen liittyviä neuvoja!



Wichtig

lb

Virschäfte fir d'Sécherheet a fir Onfälle ze vermeiden

Virun eventuellen Astellungen oder aneren Aarbechten, wéi z.B. Botzen, Manutentioun, Ännerungen oder Erweiterungen,

d'prise de force ausmaachen, de Motor ausmaachen an de Schlëssel erauszéien.

Halt lech w.e.g. och un d'Indikatioune fir d'Sécherheet, déi Dir am Handbuch vun dësem Accessoire fannt!



Ważne

pl

Przepisy bezpieczeństwa i zapobiegania wypadkom

Przed rozpoczęciem wszelkich prac nastawczych lub innych, np. czyszczenie, konserwacja, przebudowa lub montaż

Wyłączyć wał odbioru mocy, zatrzymać silnik i wyciągnąć kluczyk ze stacyjki.

Przestrzegać również wskazówek dotyczących bezpieczeństwa zamieszczonych w instrukcji obsługi tego urządzenia!



Vigtigt

da

Forskrifter om sikkerhed og forebyggelse af ulykker

Før eventuel indstilling eller andet arbejde, f.eks. rengøring, vedligeholdelse, ombygning eller påmontering af dele, skal **kraftudtaget frakobles, motoren standses og tændingsnøglen trækkes ud.**

Følg også sikkerhedsanvisningerne i driftsvejledningen til dette tilbehør!



Važno

hr

Propisi o sigurnosti i sprječavanju nezgode

Prije eventualnih podešavanja ili ostalih radova npr. čišćenja, održavanja, prepravljanja ili montaže

isključite prijenosnik snage, ugasite motor i izvucite ključeve za paljenje.

Uvažite i upute o sigurnosti iz uputa za upotrebu ovog pribora!



Önemli

tr

Güvenlik ve kaza önleme ile ilgili talimatlar

Muhtemel ayar çal işmlarından veya diğer işlerden örn. temizlik, bakım, tadilat veya montaj **muylu mili kapat in, motoru durdurun ve kontak anahtarını çıkarın.**

Bu aksesuarın kullanım kılavuzundaki emniyet talimatlarını da dikkate alın !



Importante

pt

Normas de segurança e prevenção de acidentes

Antes de qualquer trabalho de ajuste ou de outra natureza, como limpeza, manutenção, modificação ou montagem,

desligar o eixo de tomada de força, desligar o motor e retirar a chave da ignição.

Devem também ser tidas em conta as recomendações de segurança constantes do manual de instruções deste acessório!



Pomembno

Varnostni predpisi in predpisi za preprečevanje nesreč

Pred namestitvijo ali drugimi deli ali posegi, na primer čiščenjem, vzdrževanjem, rekonstrukcijo ali montažo, **izklopite kardansko gred, zaustavite motor in izvlecite ključ za vžig.**

sl

Upoštevajte tudi varnostne napotke v navodilih za uporabo te opreme!



Dôležitě

Bezpečnostné predpisy a predpisy na prevenciu úrazov

Pred prípadnými nastavovacími alebo inými prácami, ako napr. čistením, údržbou, rekonštrukciou alebo pristavovaním, **vypnite vývodový hriadeľ, odstavte motor a vyťahnite kúč zo zapalovania.**

sk

Dbajte pritom tiež na bezpečnostné pokyny v návode na obsluhu k tomuto príslušenstvu!



Tähtis

Ohutus- ja ettevaatuseeskirjad

Enne võimalikke seadistus- vm töid, näiteks puhastamine, hooldus, ümber- või juurdeehitus, tuleb kaitusvõll välja lülitada, mootor seisata ja süütevõti eemaldada.

et

Järgige ka kõnealuse varustuse Kasutusjuhendis sisalduvaid ohutusjuhiseid!



Svarbu

Saugos ir atsargumo priemonių instrukcijos

Montuojant arba atliekant panašius darbus, pvz., valant, atliekant techninę priežiūrą, atliekant permontavimo arba papildomų įrenginių montavimo darbus **būtina atjungti papildomą ają pavarą, išjungti variklį ištraukti užvedimo raktelį.**

lt

Taip pat laikykitės šio įrenginio eksploatavimo vadove pateiktų saugos nurodymų!



Svarīgi

Norādes drošībai un nelaiemes gadījumu novēršanai.

Pirms iespējamiem iestatīšanas vai citiem darbiem, piemēram, tīrīšanas, apkopes, pārbūves vai piebūvēšanas **atslēdziet jūgvārpstu, izslēdziet motoru un izņemiet aizdedzes atslēgu.**

lv

Ievērojiet arī drošības norādes, kas minētas šī piederuma ekspluatācijas instrukcijā!



Důležitě

Bezpečnostní předpisy a předpisy pro ochranu před úrazem

Před případným seřizováním nebo jinou prací, např. čištění, údržba, přestavba nebo montáž, **vypněte vývodovou hřídel, vypněte motor a vytáhněte klíček ze zapalování.**

cs

Dodržujte také bezpečnostní pokyny v návodu k obsluze tohoto příslušenství!



Važno

Propisi za zaštitu na radu i sprečavanje nesreća

Pre eventualnih podešavanja ili ostalih radova npr. čišćenja, održavanja, prepravljanja ili montaže **isključite prenosnik snage, ugastite motor i izvucite ključeve za paljenje.**

sr

Obratite pažnju i na uputstva za zaštitu na radu iz uputstva za upotrebu ovog pribora!



Tábhachtach

Rialúcháin um shábháilteacht agus seachaint timpistí

Déan i gcónaí an Cumhachtdhúiseoir a dhínascadh, an t-inneall a mhúchadh agus an eochair adhainte a bhaint as sula ndéanann tú aon choigeartú nó obair eile ar an meaisín (m.sh. glanadh, cothabháil, breiseáin nó mionathruithe).

ga

Féach freisin na teoracha sábháilteachta i lámhleabhar an úsáideora, a cuireadh ar fáil i dteannta na bhfeisteas seo.



Áriðandi

is

Öryggisleiðbeiningar og fyrirmæli vegna slysaþattu

Á undan stillingavinnu eða öðru viðhaldi t.d. hreinsun, viðgerðum, breytingum eða viðbótum verður að **taka drifskafið úr sambandi, slökva á mótornum og fjarlægja kveikjulykil.**

Farið einnig eftir öryggisleiðbeiningum í notendahandbókinni sem fylgir þessum búnaði!



Σημαντικό

el

Οδηγίες ασφαλείας και πρόληψης ατυχημάτων

Πριν από κάθε ρύθμιση ή οποιαδήποτε άλλη εργασία, όπως π.χ. καθαρισμός, συντήρηση, τροποποίηση ή επέκταση

απενεργοποιήστε τον κινητήριο άξονα και τον κινητήρα και τραβήξτε το κλειδί ανάφλεξης.

Λάβετε υπόψη και τις υποδείξεις ασφαλείας του εξοπλισμού αυτού, που περιέχονται στο παρόν εγχειρίδιο λειτουργίας!



Важно

ru

Предписания по технике безопасности и правила безопасности

Перед выполнением настройки или других работ, например чистки, технического обслуживания, переоборудования или установки, **выключите вал отбора мощности, отключите двигатель и выньте ключ зажигания.**

Выполняйте указания по технике безопасности, содержащиеся в инструкции по эксплуатации этих принадлежностей!



Увага!

uk

Вказівки з техніки безпеки та запобігання нещасним випадкам

Перед виконанням будь-яких установочних чи інших робіт, таких як чищення, технічне обслуговування, монтаж або демонтаж, **необхідно зупинити розподільчий вал, вимкнути мотор та витягнути ключ запалення.**

Також дотримуйтеся вказівок з техніки безпеки, що подані в інструкції з користування обладнанням!



Важно

bg

Правила по техника на безопасност и охрана на труда

Преди евентуални работи по настройката или други работи, напр. почистване, поддръжка, реконструкция или пристрояване

изключете силоотводния вал, спрете двигателя и извадете ключа за запалването.

Съблюдавайте и инструкциите по безопасността в ръководството за работа към тези принадлежности!



Important

ro

Prevederi de siguranță și prevenire a accidentelor

Înainte de orice lucrări de instalare sau de alt fel, cum ar fi curățarea, întreținerea, modificarea sau montarea de piese suplimentare **a se decupla priza de putere, a se opri motorul și a se scoate cheia de contact.**

Respectați și indicațiile de siguranță din manualul de utilizare al acestui accesoriu!



重要

ja

安全規定および 事故防止規定

調整作業または清掃、メンテナンス、改造、取り付けなどの作業を行う際は、あらかじめ動力取り出し装置の電源を切り、エンジンを停止させ、イグニッションキーを抜いてください。

また、本付属品の取扱説明書に記載されている安全上の注意事項も守ってください！



1. Antriebseinheit ausbauen

- 1.1 Behälter des AXEO an den Kran hängen.



- 1.2 Das Rührwerk des AXEO ausbauen.

Weitere Informationen zum Ausbau des AXEO-Rührwerks finden Sie in der AXEO-Betriebsanleitung, Kapitel „Rührwerk demontieren“.



- 1.3 Die beiden Kabelbinder für die Beleuchtungskabel auf der rechten und linken Seite entfernen.

Sie finden die beiden Kabelbinder an der Seite des Behälters, in der Nähe der vorderen Behälterschrauben.





- 1.4 Die Positionen der vorderen rechten und hinteren linken Behälterschraube markieren.
Diese Markierungen ermöglichen Ihnen, beim späteren Zusammenbau, das Ausrichten von Behälter und Rahmen bzw. Rührwerksantrieb.



- 1.5 Behälterschrauben lösen.





- 1.6 Zwei Vierkanthölzer mit einer Höhe bzw. Breite von min. 80 mm bereit legen.



- 1.7 Behälter anheben, Vierkanthölzer auf den Rahmen legen und Behälter absenken.
Behälter eingehängt lassen!



WARNUNG



Unfallgefahr!

Behälter kann vom Rahmen gestoßen werden.
Verletzung möglich.

- ▶ Behälter gegen herabfallen sichern.



- 1.8 **Nur AXEO HydroControl (HC):**
Drehzahlsensor demontieren.
Sie finden den Sensor an der rechten Seite der Antriebseinheit.

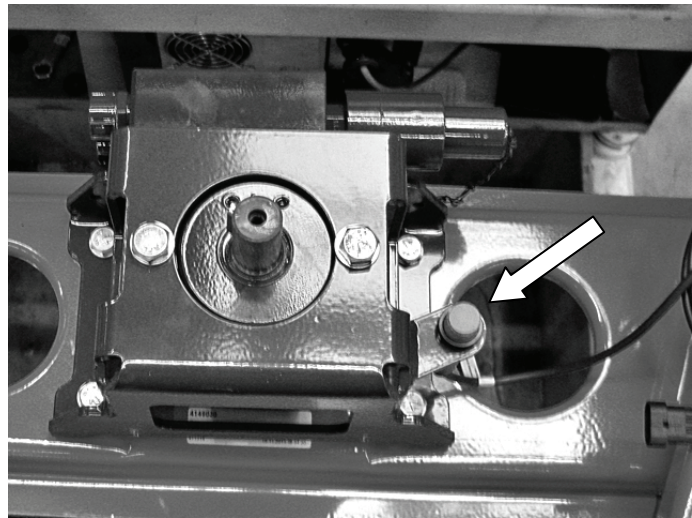

- 1.9 **Nur AXEO HydroControl (HC):**
Steckverbindung des Proportionalventils lösen.

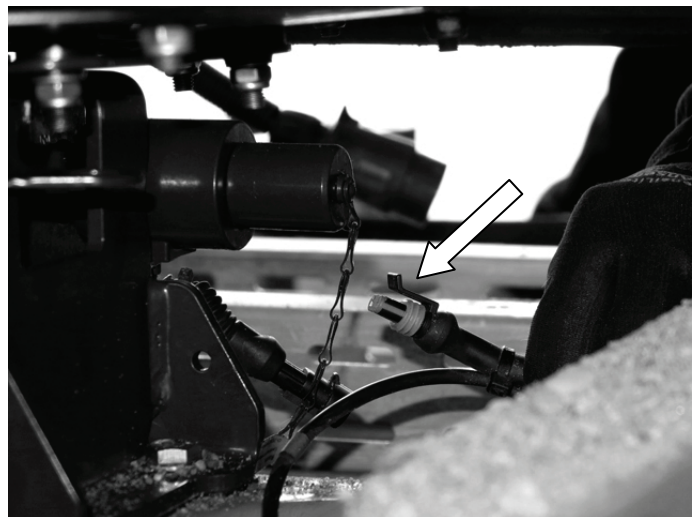



- 1.10 Verschraubung der Antriebseinheit lösen, Schrauben und Muttern entsorgen.

Die Muttern sind selbstsichernd, sie dürfen nur einmal verwendet werden.

Ein neuer Satz Schrauben, Muttern und Scheiben für die Befestigung der Antriebseinheit liegt dem Umrüstsatz bei.





- 1.11 Die gesamte Antriebseinheit (Konsole, Motor, Wurfscheibe etc.) herausnehmen.

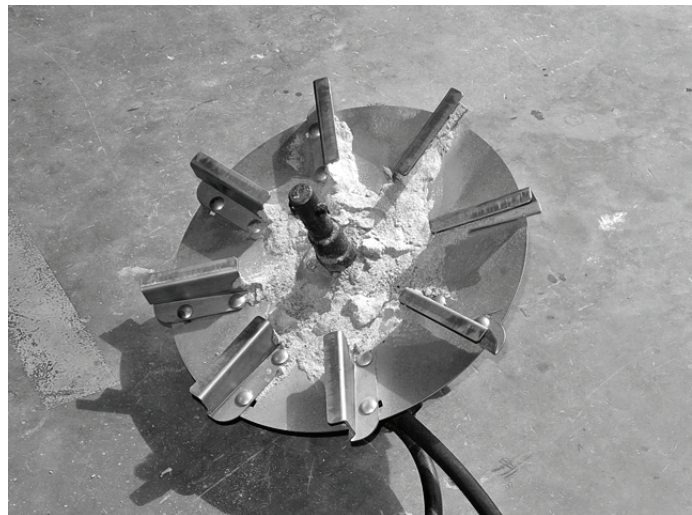
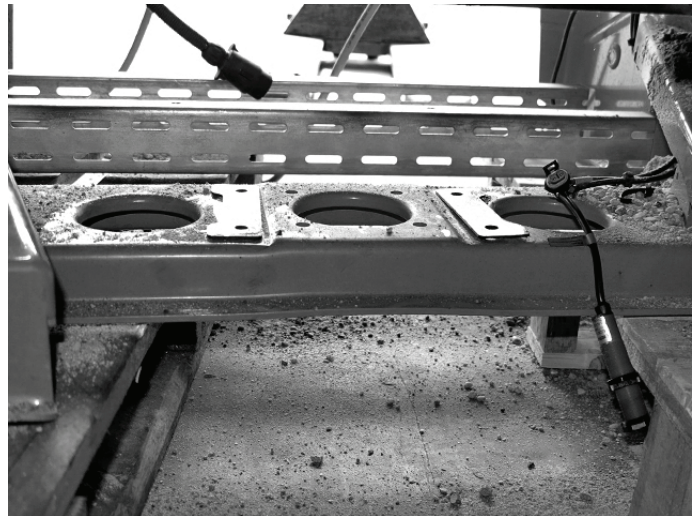

- 1.12 Die Distanzplatten vom Rahmen nehmen und aufbewahren.
Die Distanzplatten dienen zum Ausrichten des Antriebs.

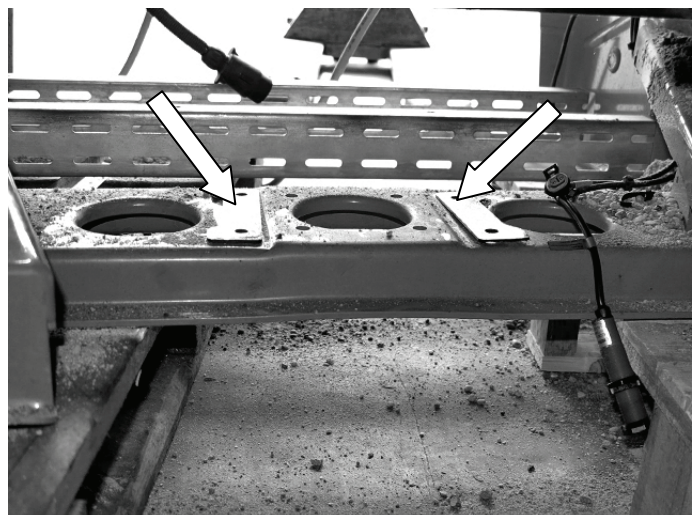



2. Antriebseinheit demontieren

- 2.1 Die Wurfscheibe von der Antriebseinheit lösen und die Schrauben entsorgen.

Diese Schrauben sind selbstsichernd, sie dürfen nur einmal verwendet werden.

Ein neuer Satz Schrauben, für die Befestigung der Wurfscheibe liegt dem Umrüstsatz bei.



- 2.2 Die Wurfscheibe von der Antriebseinheit abnehmen.





- 2.3 An der Rührwerkswelle den Gewindestift (M8) entfernen.

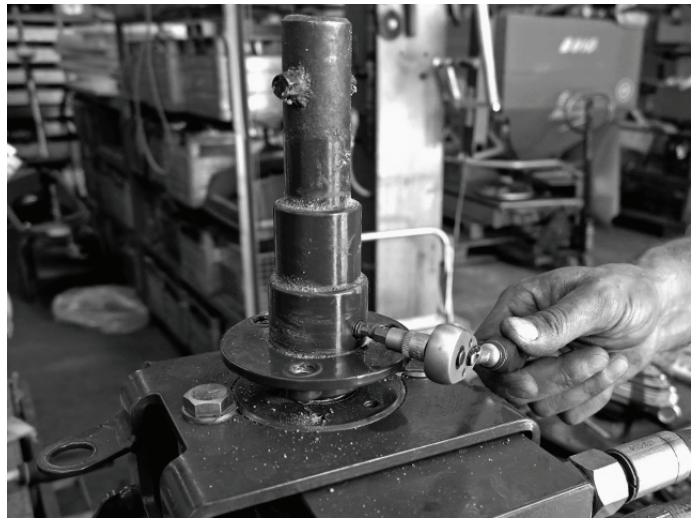

- 2.4 Die alte Rührwerkswelle 43 mm über ihrem unteren Rand anreißen.

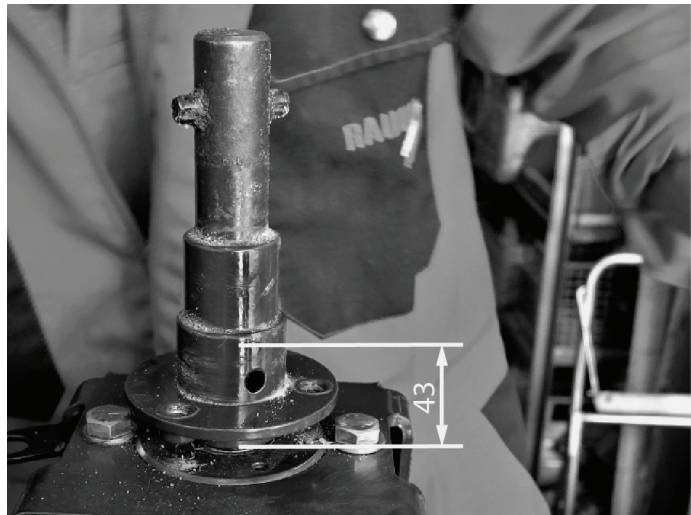



- 2.5 Die alte Rührwerkswelle etwas mehr als eine Sägeblattdicke oberhalb der angerissenen 43 mm abtrennen.



- 2.6 Den unteren Teil der alten Rührwerkswelle von der Motorwelle abziehen.

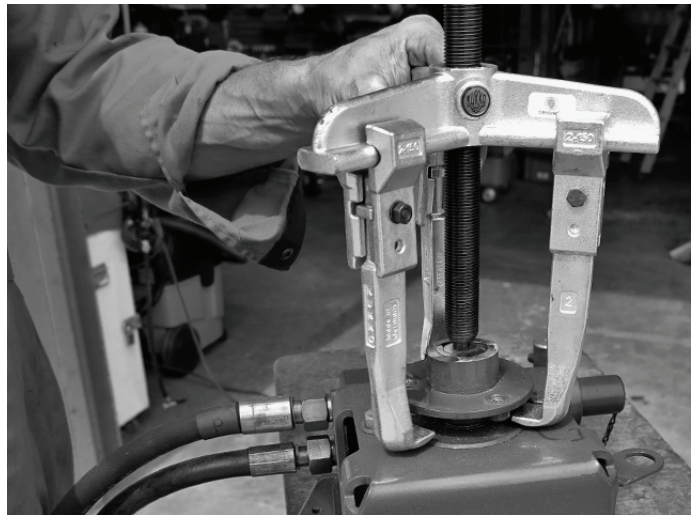



2.7 Motor ausbauen, Schrauben und Muttern entsorgen.

Die Muttern sind selbstsichernd, sie dürfen nur einmal verwendet werden.

Ein neuer Satz Schrauben, Muttern und Scheiben für die Befestigung der Antriebseinheit liegt dem Umrüstsatz bei.

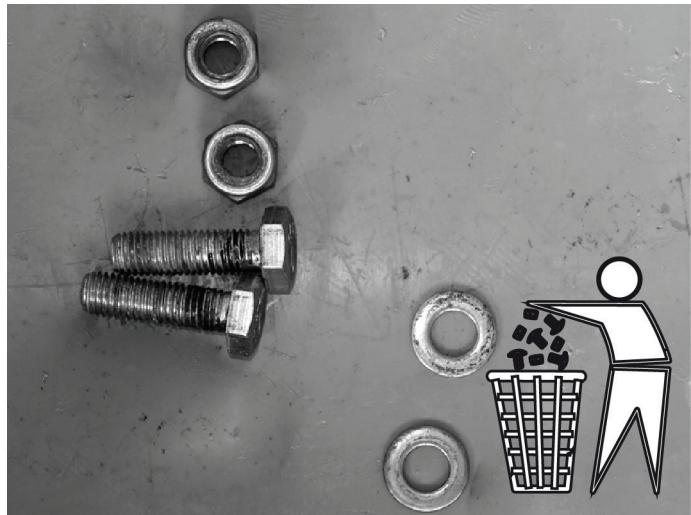

2.8 Die alte Antriebskonsole entsorgen.

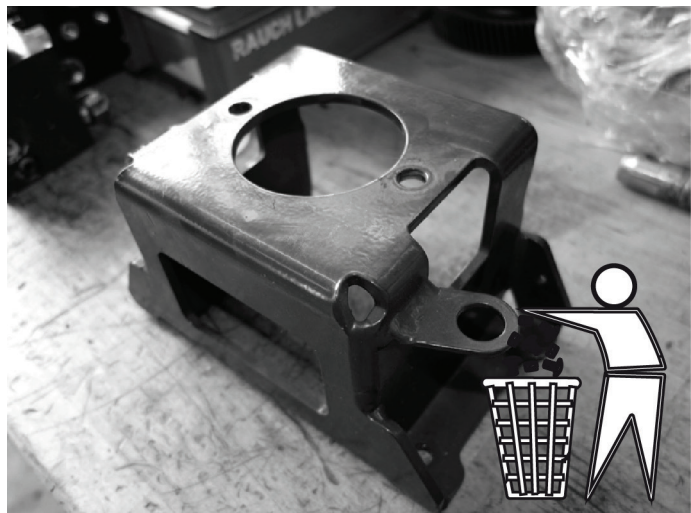



3. Antriebseinheit zusammenbauen

- 3.1 Schrauben, Muttern und Scheiben für die Befestigung des Motors in der Antriebskonsole bereit legen.

Die Schrauben und Scheiben liegen dem Umrüstsatz bei.

Legende:

- a) Sechskantschraube M12 x 45
- b) Scheibe
- c) Sechskantmutter M12 (selbstsichernd)

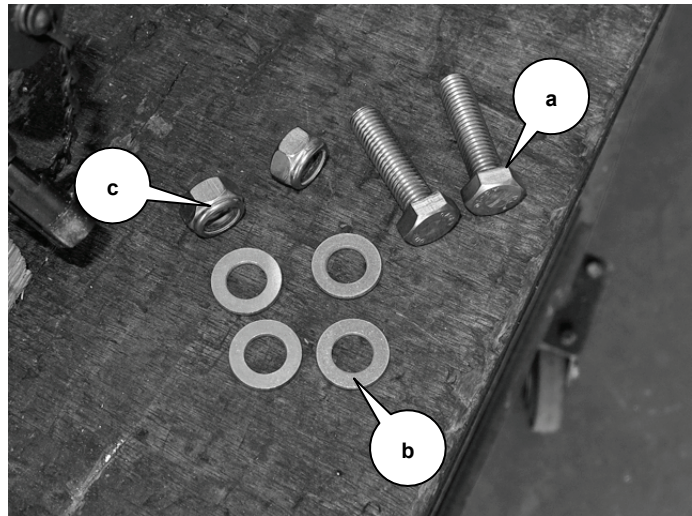

- 3.2 Motor in die neue Antriebskonsole schrauben, **Anzugsmoment 70 Nm.**

Legende:

- a) Sechskantschraube M12 x 45
- b) Scheibe
- c) Sechskantmutter M12 (selbstsichernd)

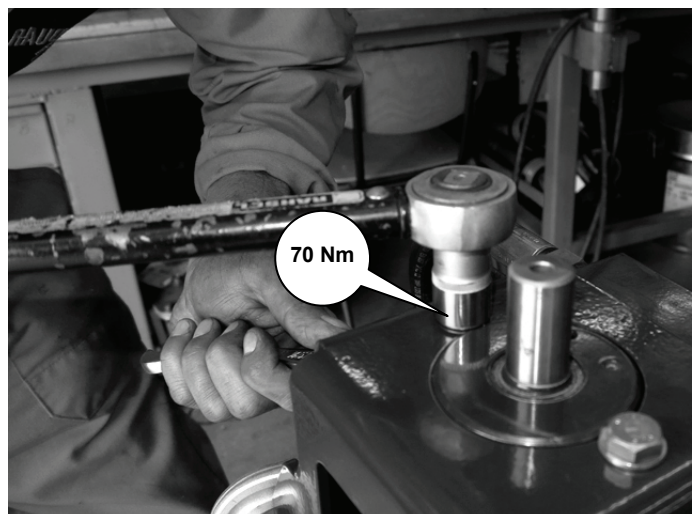
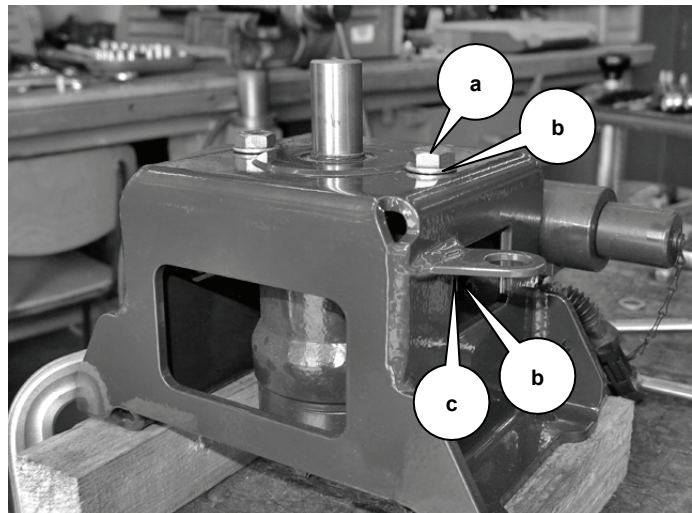



3.3 Motorwelle fetten.

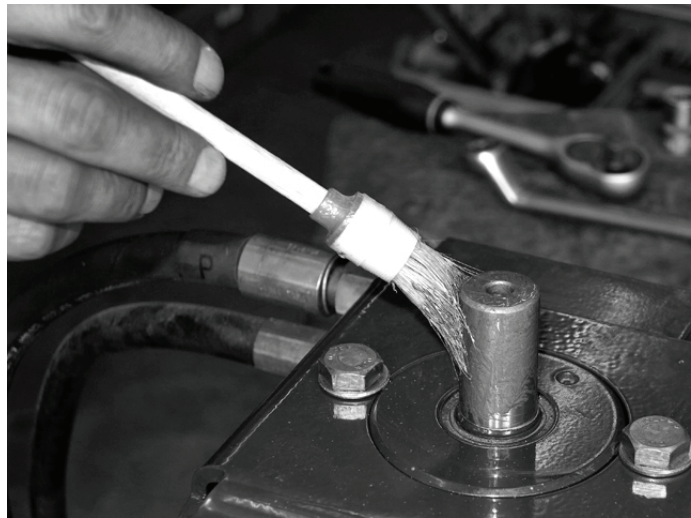

3.4 Die drei Gewinde für die Wurfscheibenaufnahme an der neuen Rührwerkswelle nachschneiden.
Beim Lackieren kann Lack in die Bohrungen gelangen und die Gewinde zusetzen.



3.5 Rührwerkswelle **innen** fetten, auch die Bohrung für den Gewindestift.





- 3.6 Die Bohrung für den Gewindestift bzw. die Nut in der Rührwerkswelle auf die Passfeder der Motorwelle ausrichten.

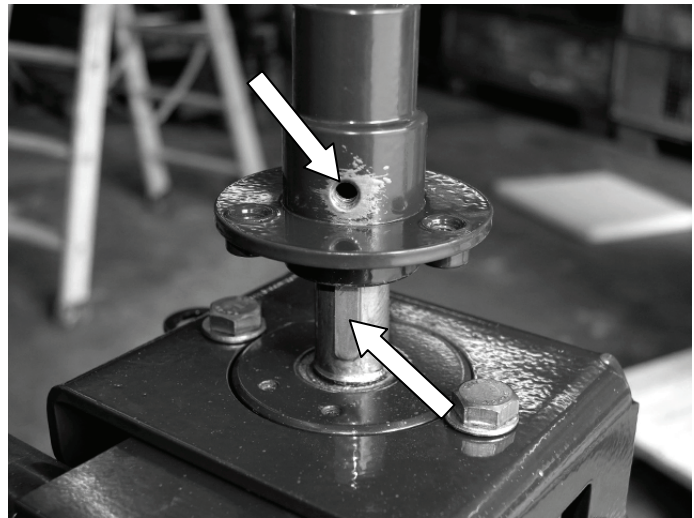

- 3.7 Rührwerkswelle mit einem Kunststoffhammer fügen.



- 3.8 Gewindesttift einschrauben, Rührwerkswelle festklemmen.





3.9 Wurfscheibe auf die
Rührwerkswelle setzen.



3.10 Die drei Schrauben mit
Selbstsicherung und Scheiben für
die Wurfscheibe bereit legen.
*Die Schrauben und Scheiben
liegen dem Umrüstsatz bei.*

Legende:

- a) Sechskantschrauben M8 x 20
(selbstsichernd)
- b) Scheiben

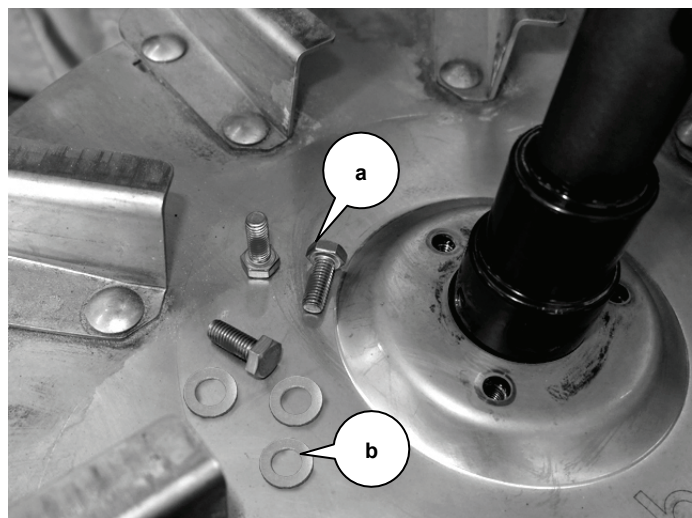

3.11 Wurfscheibe festschrauben.
Anzugmoment 22 Nm.

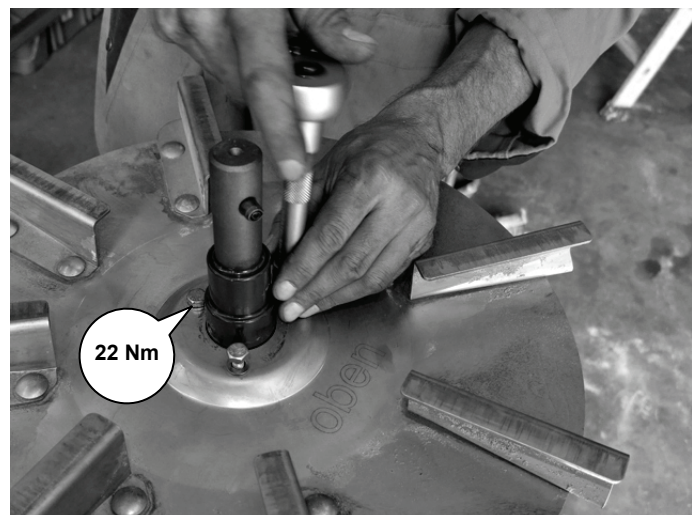



4. Antriebseinheit einbauen

- 4.1 Die Sechskantschrauben, Sechskantmuttern, Scheiben und Distanzplatten für den Konsoleneinbau bereit legen.

Die Distanzplatten dienen zum Ausrichten von Behälter und Rahmen bzw. Rührwerksantrieb.

Legende:

- a) Scheiben
- b) Distanzplatten
- c) Sechskantmuttern M10
- d) Sechskantschrauben M10 x 30

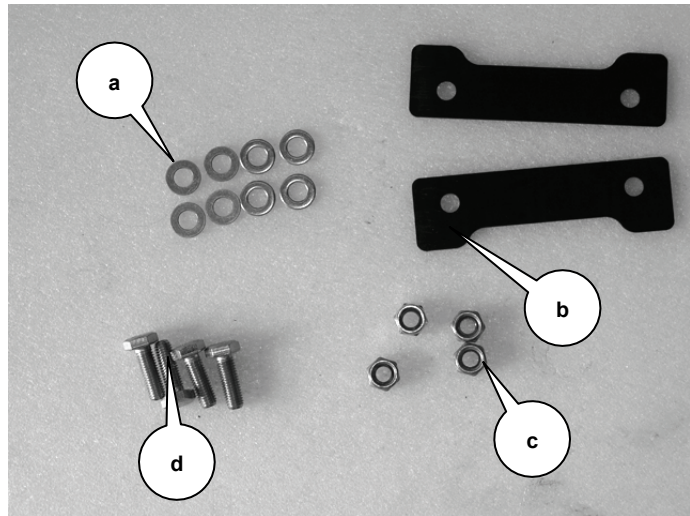

- 4.2 Antriebseinheit montieren, **Anzugsmoment 60 Nm.**

Legende:

- a) Sechskantschrauben M10 x 30
- b) Scheiben
- c) Distanzplatten
- d) Sechskantmuttern M10

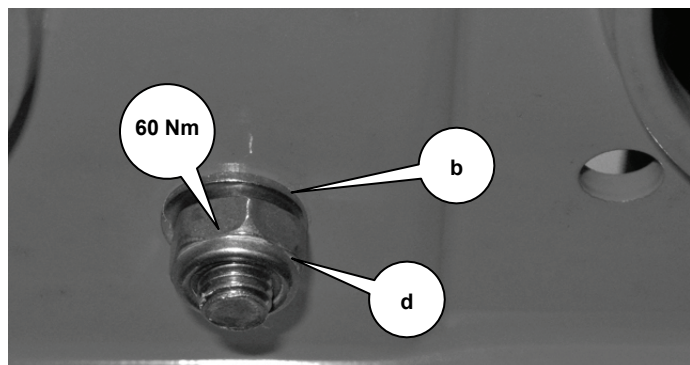
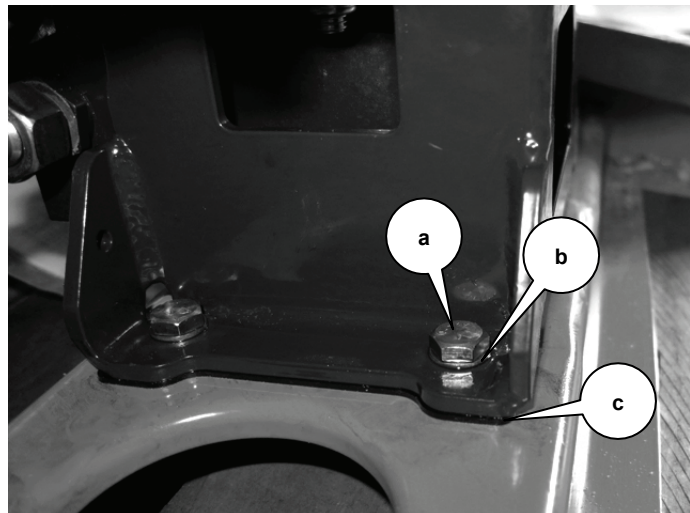



- 4.3 **Nur AXEO HydroControl (HC):**
Drehzahlsensor montieren.
*Abstand vom Sensor zur
Aufnehmerscheibe: 3 bis 5 mm*

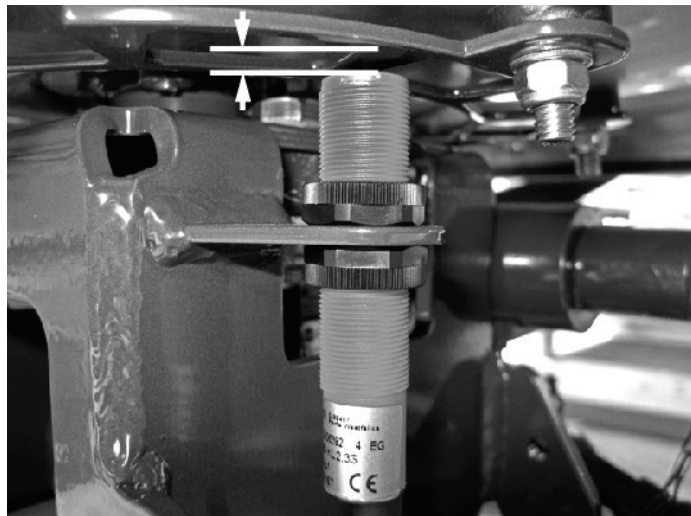

- 4.4 **Nur AXEO HydroControl (HC):**
Stecker des Proportionalventils
wieder einstecken.

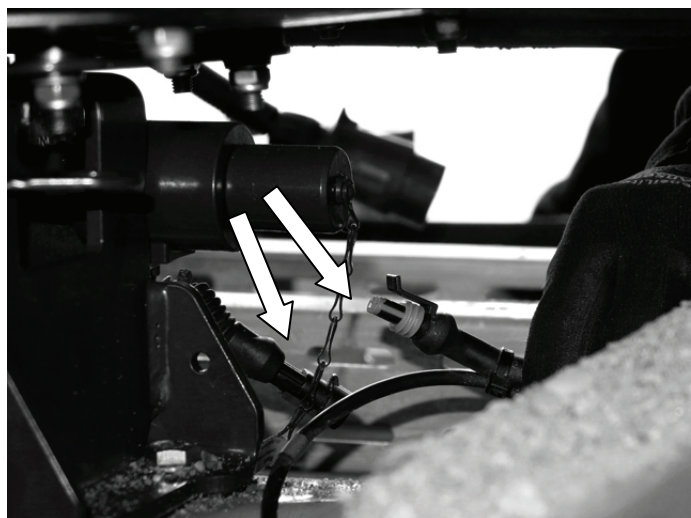

- 4.5 **Nur AXEO HydroControl (HC):**
Den Stecker mit einem
Kabelbinder an der Konsole
befestigen.

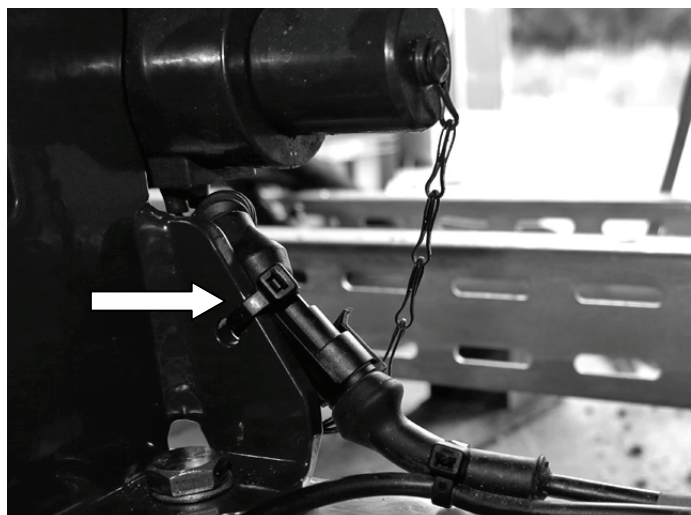



- 4.6 Behälter anheben und die Vierkanthölzer herausnehmen.



- 4.7 Behälter auf den Rahmen aufsetzen und anhand der Markierungen ausrichten.

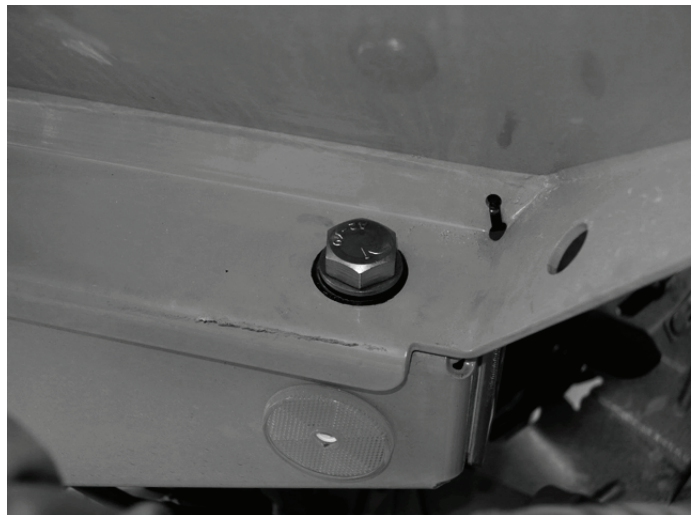



- 4.8 Behälterschrauben anziehen,
Anzugsmoment: 120 Nm

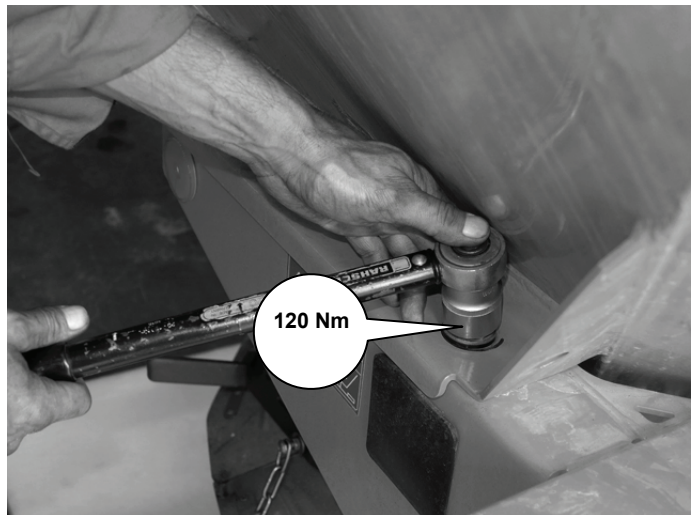

- 4.9 Beide Beleuchtungskabel mit
einem Kabelbinder straff am
Behälter befestigen.

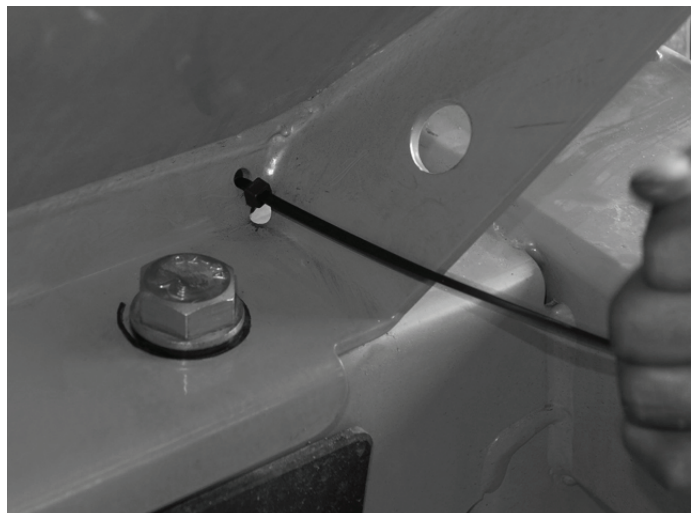



- 4.10 Rührwerk wieder einbauen.
Weitere Informationen zum Einbau des AXEO-Rührwerks finden Sie in der AXEO-Betriebsanleitung, Kapitel „Rührwerk demontieren“.



- 4.11 Behälter vom Kran nehmen.



- 4.12 Axialspiel und Abstand des Rührwerks vom Boden kontrollieren.
Das Rührwerk muss mit ca. 1 mm Spiel auf der Rührwerkswelle sitzen und sich frei drehen können.

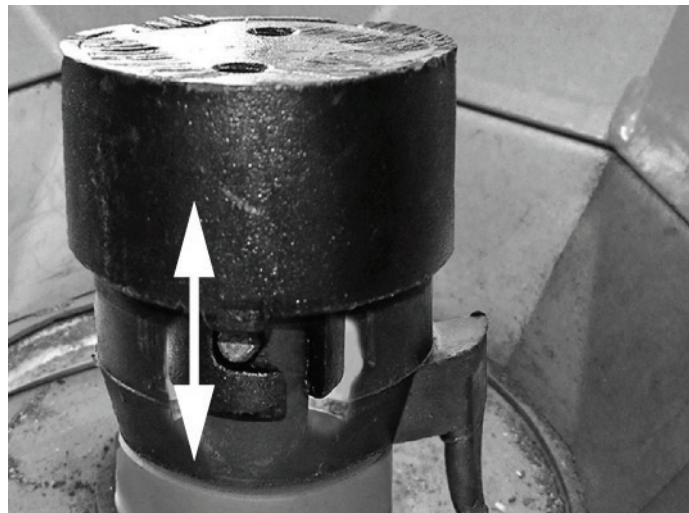



4.13 Wenn Spiel vorhanden, dieses aber kleiner als 1 mm ist:

Feilen Sie am Bajonett etwas Material ab.

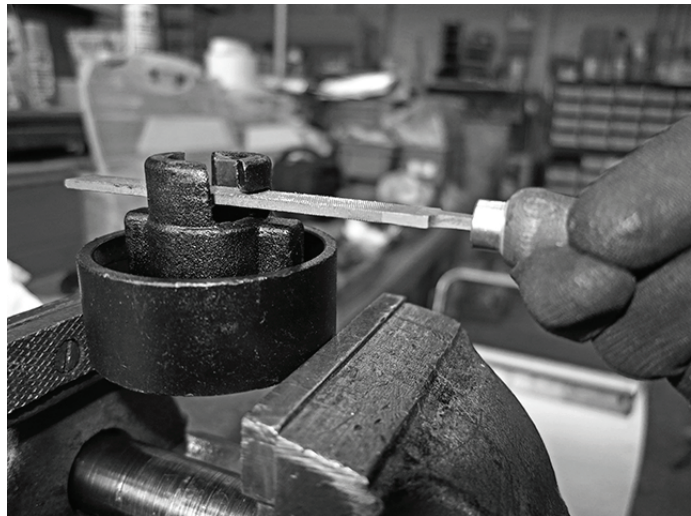

4.14 Wenn das Rührwerk klemmt oder sich nicht montieren lässt:

Unterlegen Sie den Antrieb mit zusätzlichen Distanzscheiben (2 mm).



4.15 Funktion kontrollieren, Probelauf durchführen.

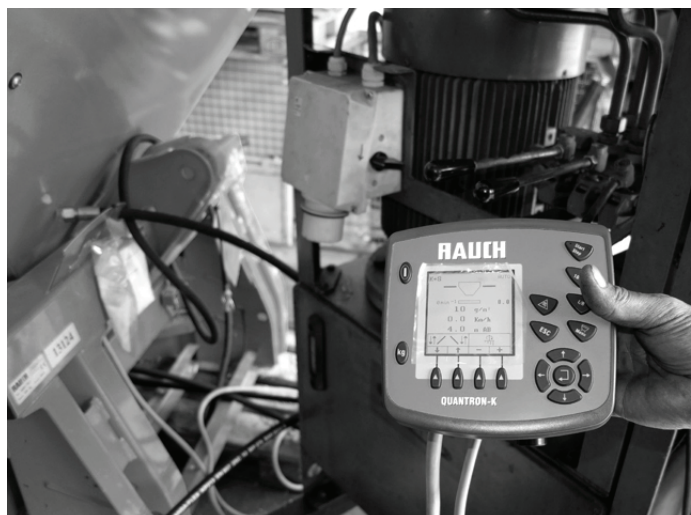

Bei bestandener Funktionskontrolle bzw. bestandem Probelauf, ist die Umrüstung beendet.



Umrüstsatz AXEO





1. Aandrijfeenheid verwijderen

- 1.1 Container van de AXEO aan de kraan hangen.



- 1.2 Het roerwerk van de AXEO verwijderen.

Verdere informatie bij het verwijderen van het AXEO-roerwerk vindt u in de AXEO-gebruikshandleiding, hoofdstuk 'Roerwerk demonteren'.



- 1.3 De beide kabelbinders voor de verlichtingskabels aan de linker- en de rechterzijde verwijderen.

U vindt beide kabelbinders aan de zijde van de container, in de buurt van de voorste containerschroeven.





- 1.4 De posities van de voorste rechter en achterste linker containerschroef markeren.
Deze markeringen maken u het uitlijnen van container en frame of roerwerk aandrijving mogelijk wanneer u later de montage uitvoert.



- 1.5 Containerschroeven lossen





- 1.6 Twee houten balken met een hoogte of breedte van 80 mm klaar leggen.



- 1.7 Container opheffen, houten balken op het frame leggen en container laten zakken.
Container in hangende positie laten!



⚠ WAARSCHUWING



Gevaar voor ongelukken!

Container kan van het frame geduwd worden.
Letsels mogelijk.

- ▶ Container beveiligen tegen omlaag vallen.



1.8 Enkel AXEO HydroControl (HC):

Toerentalsensor demonteren.

U vindt de sensor aan de rechterzijde van de aandrijfeenheid.

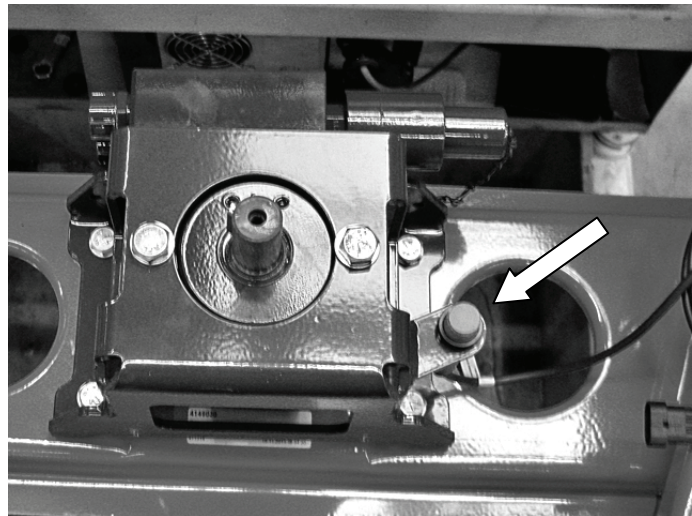

1.9 Enkel AXEO HydroControl (HC):

Steekverbinding van de proportionele klep lossen.

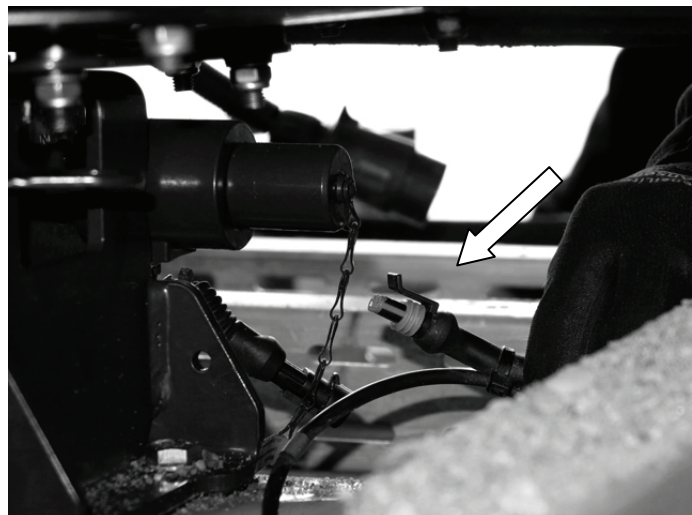



- 1.10 Schroefverbinding van de aandrijfeenheid lossen, schroeven en moeren afdanken.
De moeren zijn zelfborgend; ze mogen slechts eenmaal gebruikt worden.
Een nieuwe set schroeven, moeren en schijfjes voor de bevestiging van de aandrijfeenheid is bij de upgradeset gevoegd.





- 1.11 De gehele aandrijfeenheid (console, motor, strooischijf enz.) eruit nemen.

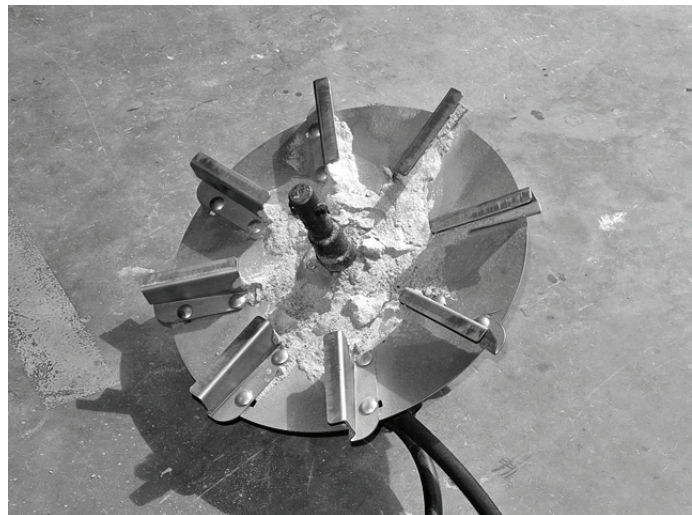
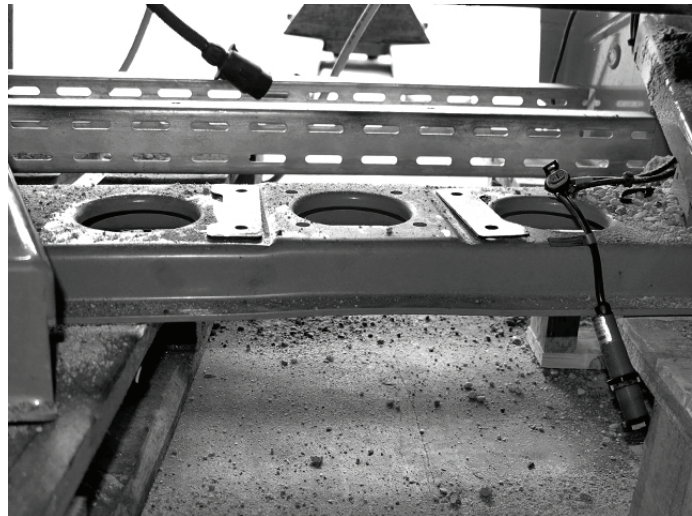

- 1.12 De afstandsplaten van het frame nemen en bewaren.
De afstandsplaten dienen om de aandrijving uit te lijnen.

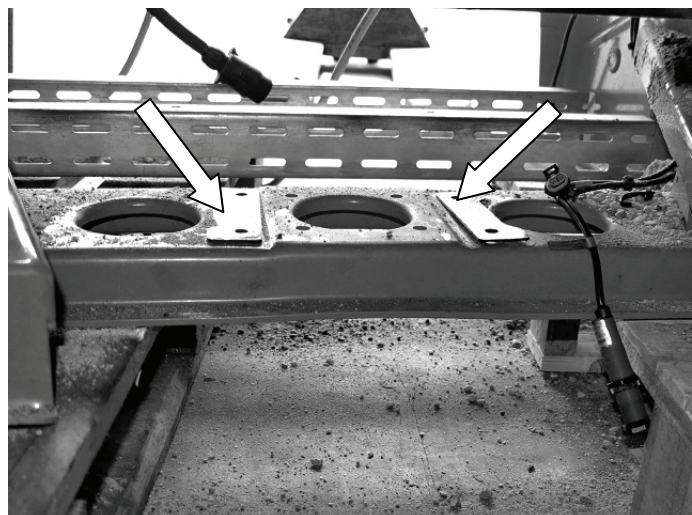



2. Aandrijfeenheid demonteren

- 2.1 De strooischijf van de aandrijfeenheid losmaken en de schroeven afdanken.

Deze schroeven zijn zelfborgend; ze mogen slechts eenmaal gebruikt worden.

Een nieuwe set schroeven voor de bevestiging van de aandrijfeenheid is bij de upgradeset gevoegd.



- 2.2 De strooischijf van de aandrijfeenheid afnemen.





- 2.3 Aan de as van het roerwerk de schroefdraadstift (M8) verwijderen.

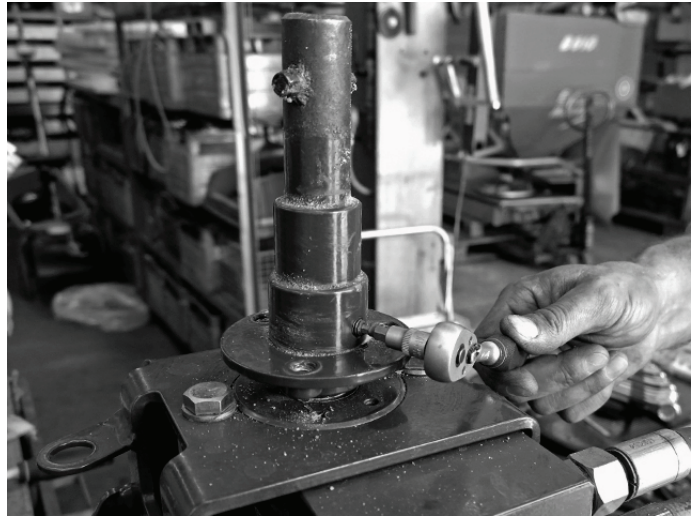

- 2.4 De oude as van het roerwerk 43 mm boven haar onderste rand optrekken.

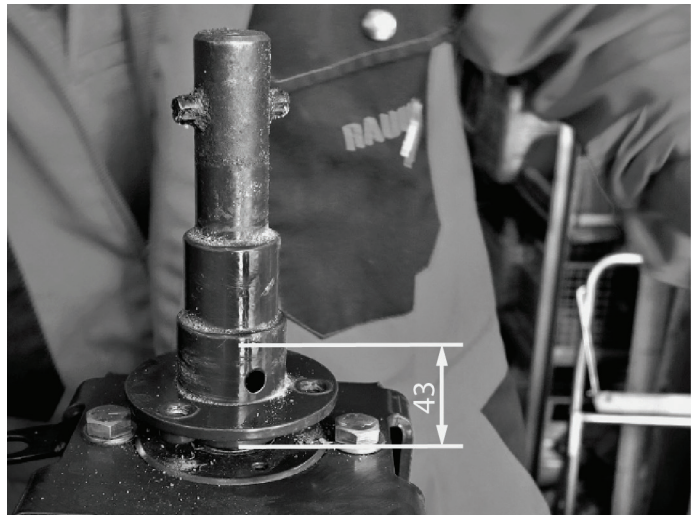



- 2.5 De oude as van het roerwerk iets meer dan de dikte van een zaagblad boven de opgetrokken 43 mm afsnijden.



- 2.6 Het onderste deel van de oude as van het roerwerk aftrekken van de motoras.

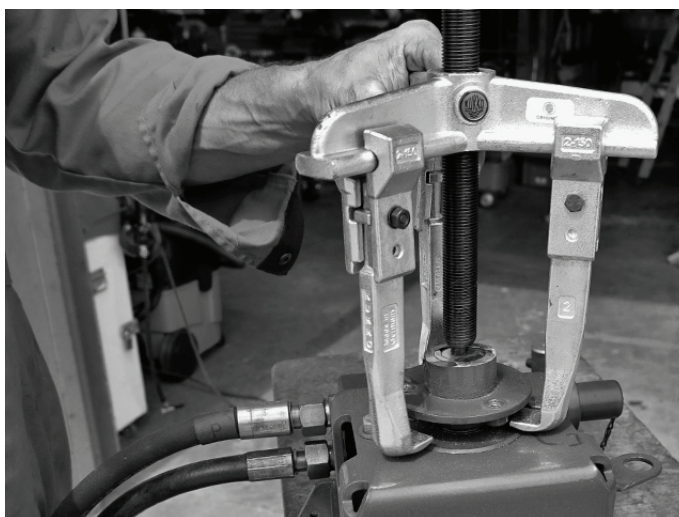



2.7 Motor demonteren, schroeven en moeren afdanken.

De moeren zijn zelfborgend; ze mogen slechts eenmaal gebruikt worden.

Een nieuwe set schroeven, moeren en schijfjes voor de bevestiging van de aandrijfeenheid is bij de upgradeset gevoegd.

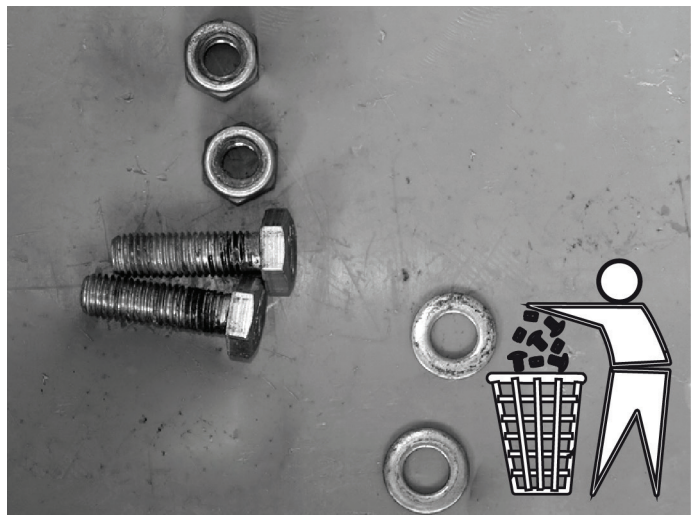

2.8 De oude aandrijfconsole afdanken.

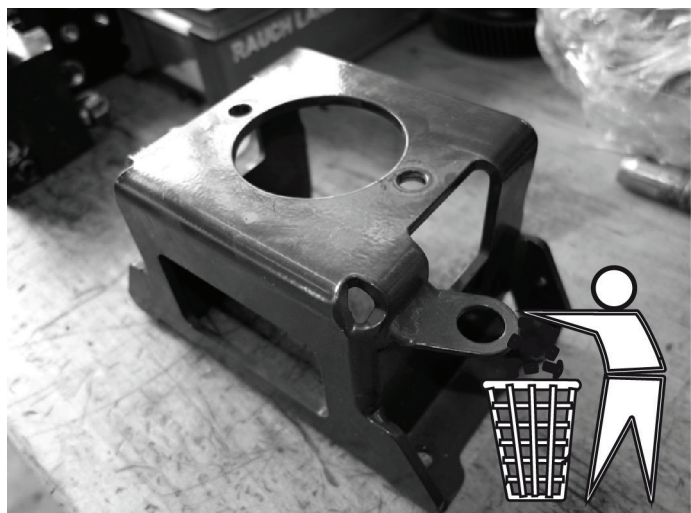



3. Aandrijfeenheid ineenzetten

3.1 Schroeven, moeren en schijfjes voor de bevestiging van de motor in de aandrijfconsole klaar leggen.

De schroeven en schijven zijn bij de upgradeset gevoegd.

Legenda

- a) Zeskantschroef M12 x 45
- b) Schijf
- c) Zeskantmoer M12 (zelfborgend)

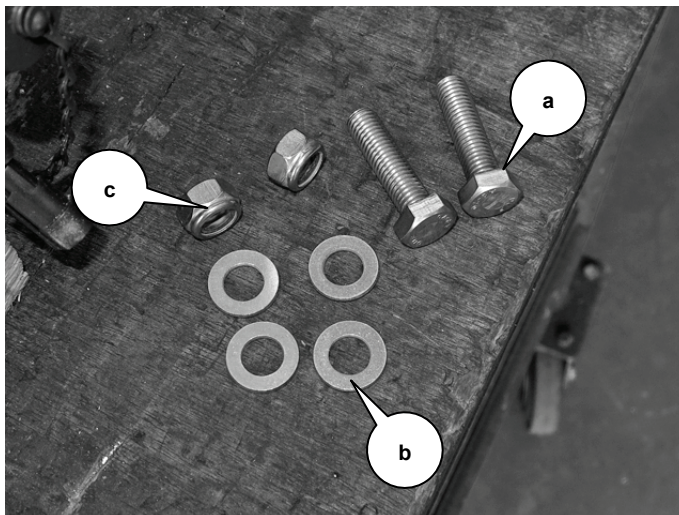

3.2 Motor in de nieuwe aandrijfconsole schroeven, **aanhaalmoment 70 Nm.**

Legenda

- a) Zeskantschroef M12 x 45
- b) Schijf
- c) Zeskantmoer M12 (zelfborgend)

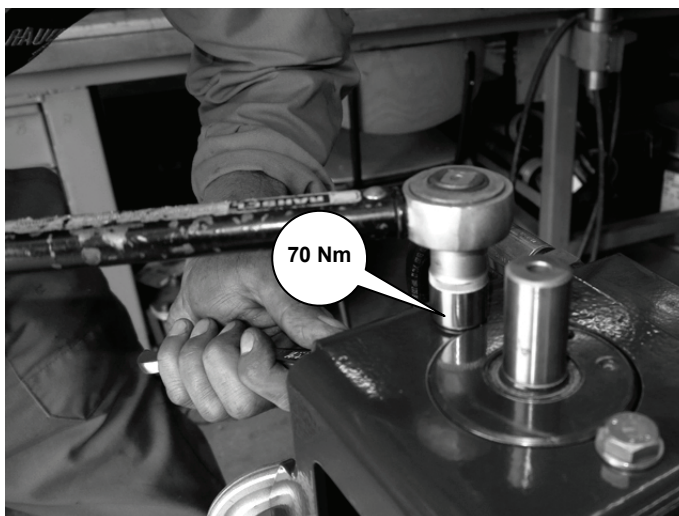
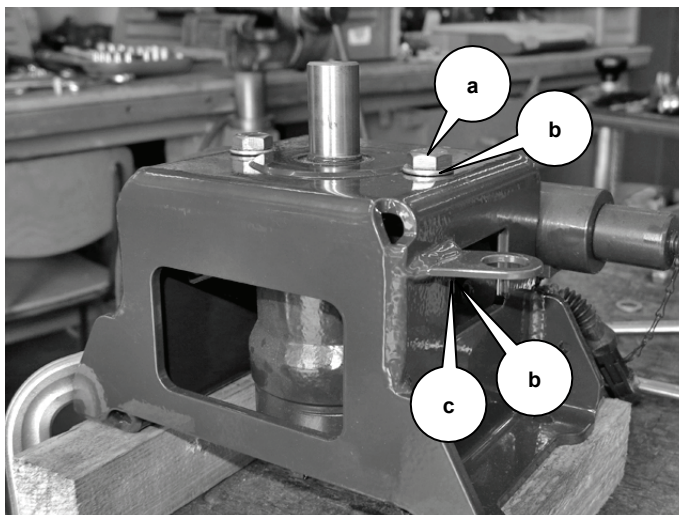



3.3 Motoras invetten.



3.4 De drie schroefdraden voor de strooischijfopname aan de nieuwe roerwerkas bijsnijden.
Bij het lakken kan lak in de boorgaten terechtkomen en de schroefdraden aantasten.



3.5 Roerwerkas **vanbinnen** invetten, inclusief het boorgat voor de schroefdraadstift.





- 3.6 Het boorgat voor de schroefdraadstift of de groef in de roerwerkas op de pasveer van de motoras uitlijnen.

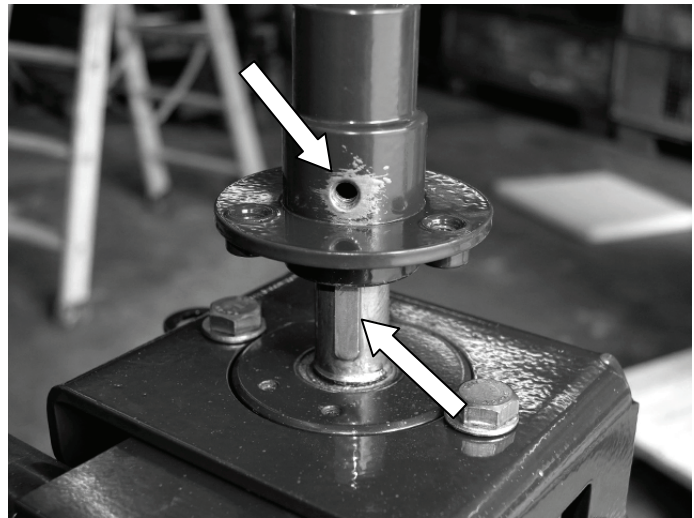

- 3.7 Roerwerkas voegen met een kunststoffen hamer.



- 3.8 Schroefdraadstift erin schroeven, roerwerkas vastklemmen.





3.9 Strooischijf op de roerwerkas zetten.



3.10 De drie schroeven met zelfborging en schijven voor de strooischijf klaar leggen.
De schroeven en schijven zijn bij de upgradeset gevoegd.

Legenda

- a) Zeskantschroeven M8 x 20 (zelfborgend)
- b) Schijven

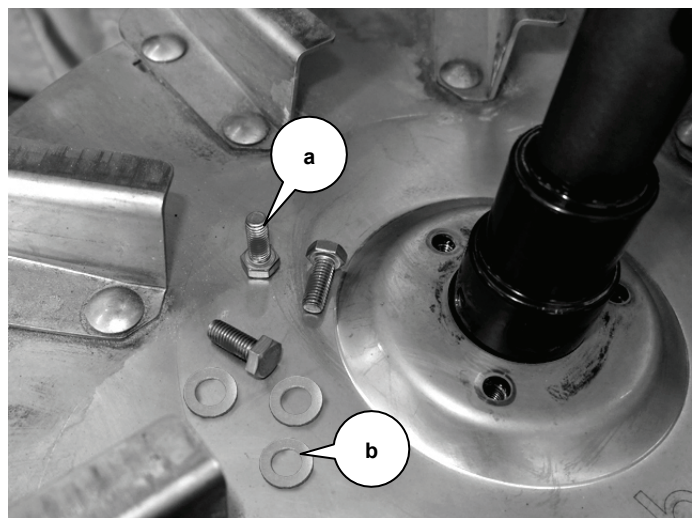

3.11 Strooischijf vastschroeven.
Aanhaalmoment 22 Nm.

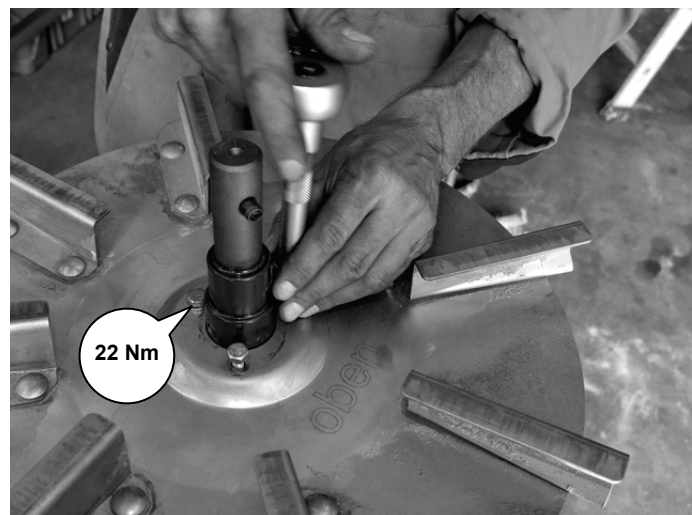



4. Aandrijfeenheid inbouwen

- 4.1 De zeskantschroeven, zeskantmoeren, schijven en afstandsplaten voor de console-inbouw klaar leggen.

De afstandsplaten dienen om de container en het frame of de roerwerk aandrijving uit te lijnen.

Legenda

- a) Schijven
- b) Afstandsplaten
- c) Zeskantmoeren M10
- d) Zeskantschroef M10 x 30

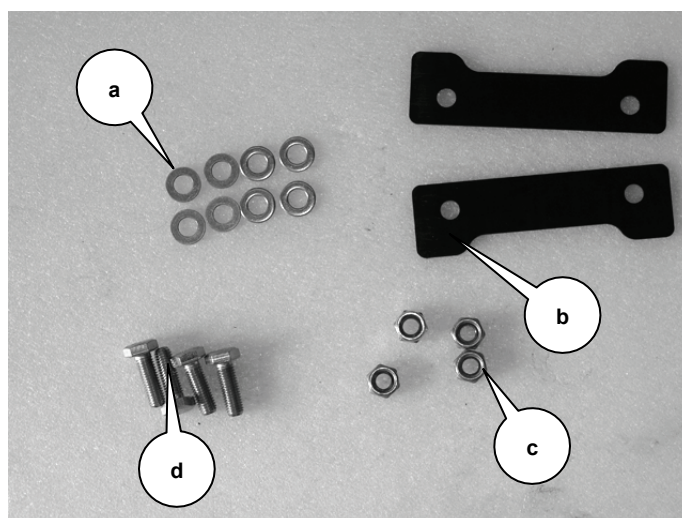

- 4.2 Aandrijfeenheid monteren, **aanhaalmoment 60 Nm.**

Legenda

- a) Zeskantschroef M10 x 30
- b) Schijven
- c) Afstandplaten
- d) Zeskantmoeren M10

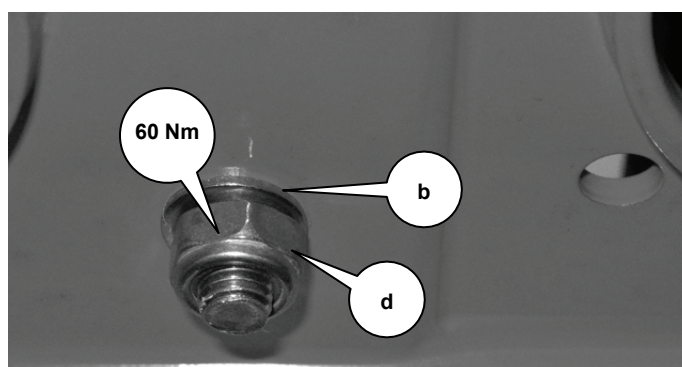
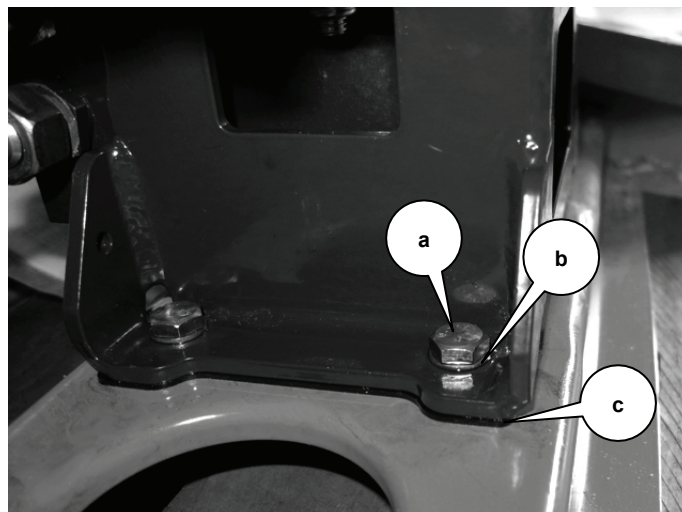



- 4.3 **Enkel AXEO HydroControl (HC):**
Toerentalsensor monteren.
Afstand vanaf de sensor tot de opnameschijf: 3 tot 5 mm

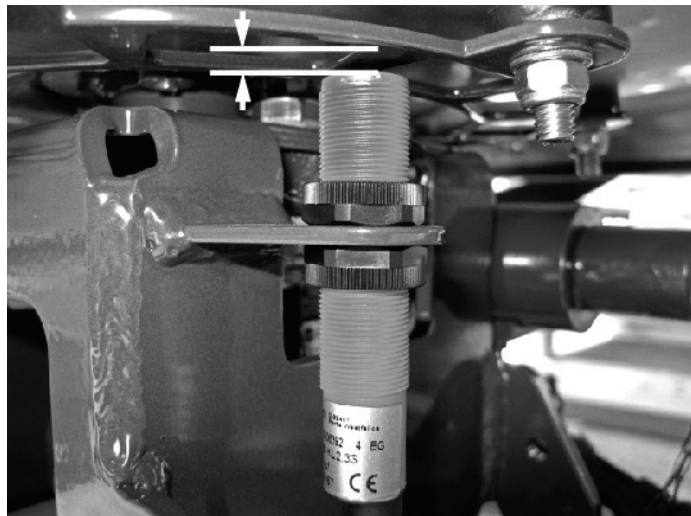

- 4.4 **Enkel AXEO HydroControl (HC):**
Stekker van het proportionele ventiel weer insteken.

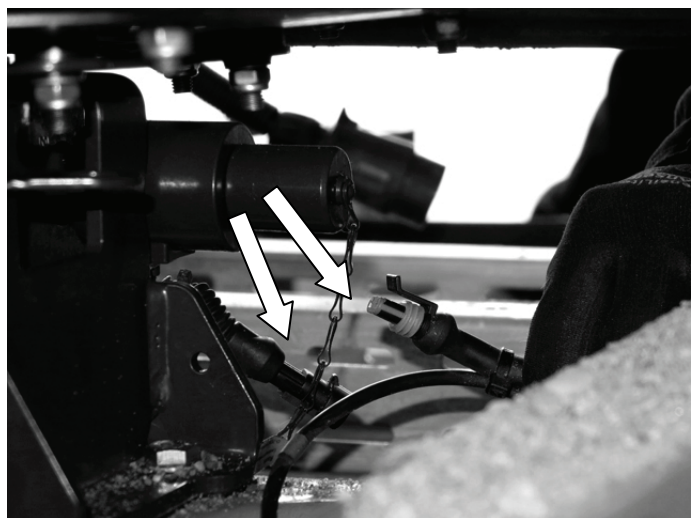

- 4.5 **Enkel AXEO HydroControl (HC):**
De stekker met een kabelbinder aan de console bevestigen.

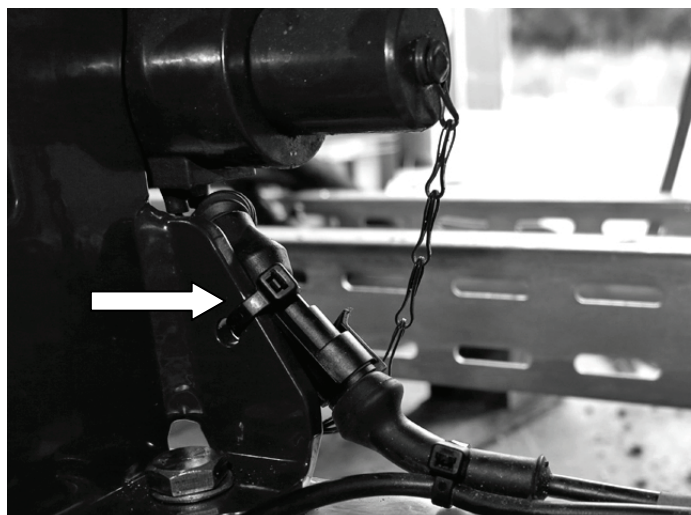



- 4.6 Container opheffen en de houten balken eruit nemen.



- 4.7 Container op het frame zetten en aan de hand van de markeringen uitlijnen.

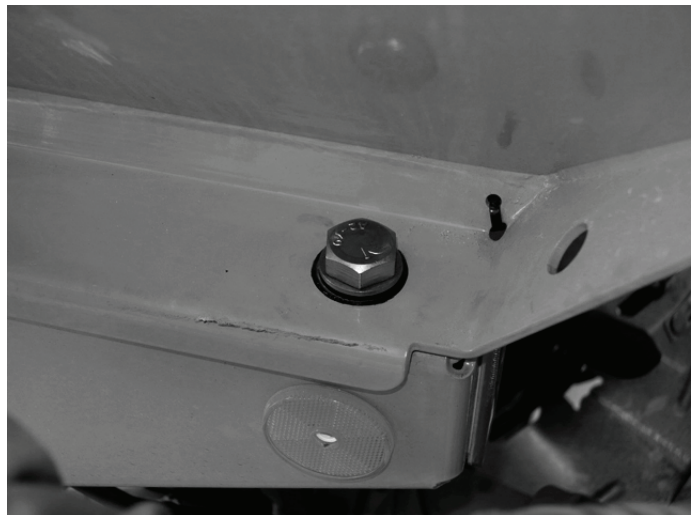



4.8 Containerschroeven aanhalen,
aanhaalmoment: 120 Nm

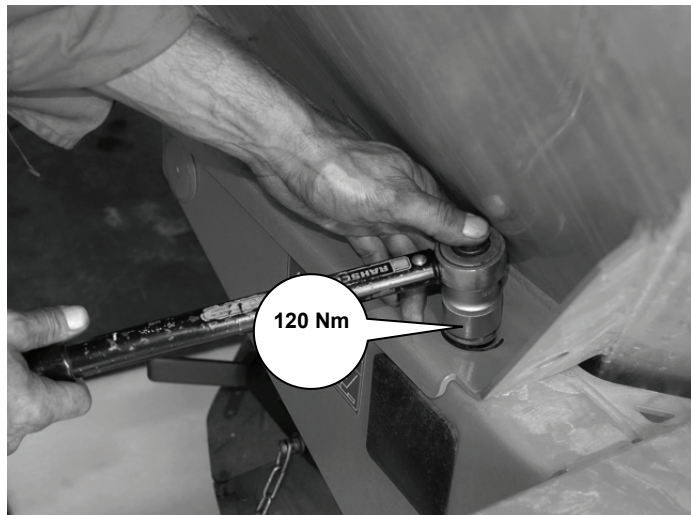

4.9 Beide verlichtingskabels met een
kabelbinder strak aan de
container bevestigen.

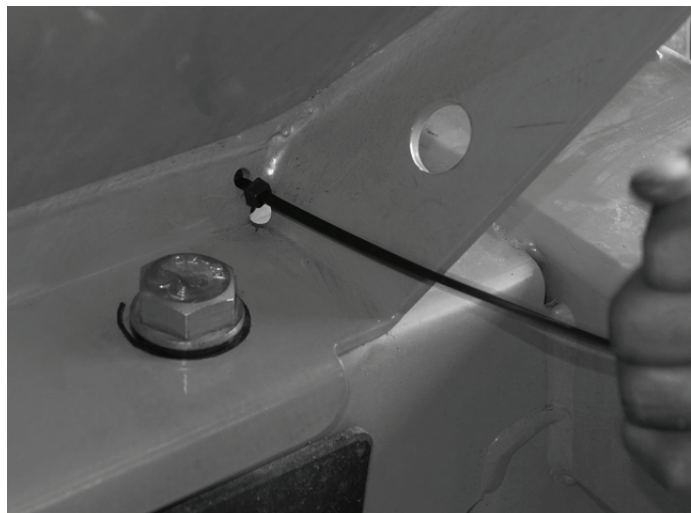



4.10 Roerwerk weer monteren.

Verdere informatie bij het monteren van het AXEO-roerwerk vindt u in de AXEO-gebruikshandleiding, hoofdstuk 'Roerwerk demonteren'.



4.11 Container van de kraan af halen.



4.12 Axiale speling en afstand van het roerwerk ten opzichte van de bodem controleren.

Het roerwerk moet met ca. 1 mm speling op de roerwerkas zitten en vrij kunnen draaien.

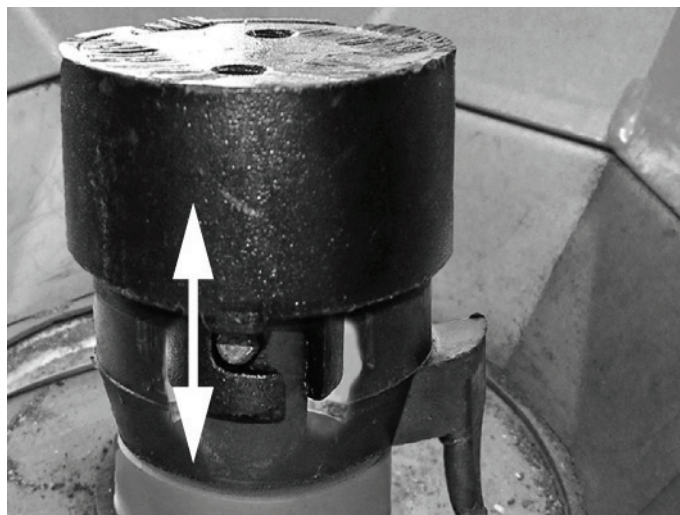



- 4.13 **Wanneer er speling aanwezig is, maar deze kleiner dan 1 mm is:**

Vijl wat materiaal van de bajonet af.

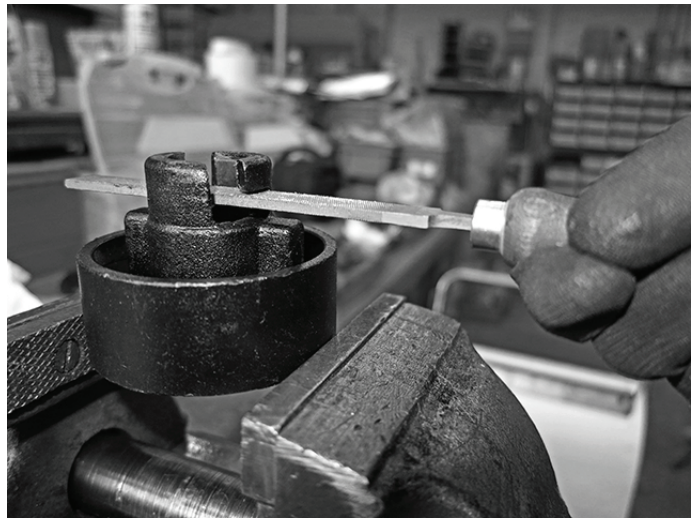

- 4.14 **Wanneer het roerwerk vastgeklemd is of niet gemonteerd kan worden:**

Leg bijkomende afstandsschijven (2 mm) onder de aandrijving.

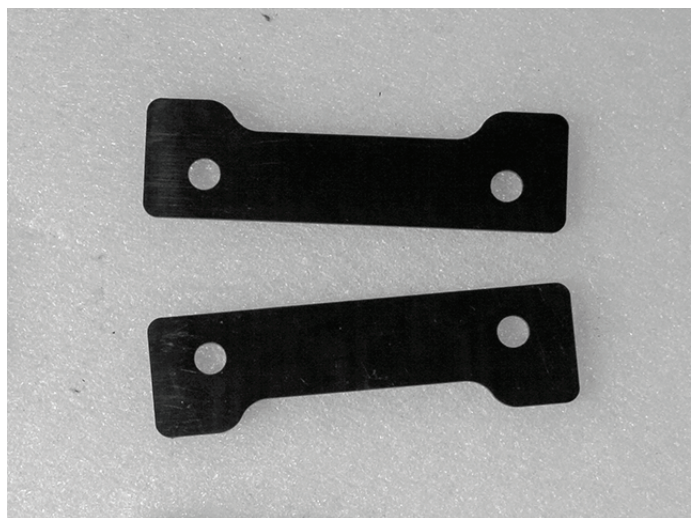

- 4.15 **Functie controleren, testrun uitvoeren.**

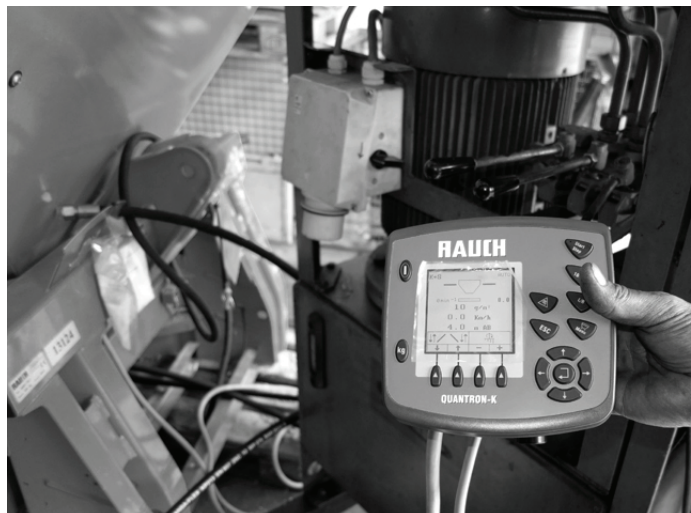

Bij geslaagde functiecontrole of geslaagde testrun is de upgrade beëindigd.



Ombouwset AXEO





1. Afmontering af drivenhed

- 1.1 Sæt AXEO-beholderen fast på kranen.



- 1.2 Afmonter AXEO-røreværket.
Du kan finde yderligere oplysninger om afmontering af AXEO-røreværket i AXEO-driftsvejledningen, kapitel "Afmontering af røreværk".



- 1.3 Fjern de to kabelbindere til belysningskablerne i højre og venstre side.
Du finder de to kabelbindere på siden af beholderen ved siden af de forreste beholderskruer.





- 1.4 Markér den forreste højre og den bageste venstre beholderskrues position.

Disse mærker gør det muligt for dig, ved den senere sammenbygning, at tilpasse beholder og ramme resp. røreværksdrev.



- 1.5 Løsn beholderskruerne.





- 1.6 Læg to firkantede træstykker med en højde og bredde på min. 80 mm parat.



- 1.7 Løft beholderen op, læg træstykkerne på rammen, og sænk beholderen ned.
Lad beholderen være fastgjort på kranen!



⚠ ADVARSEL



Risiko for ulykker!

Beholderen kan blive skubbet ned af rammen.

Risiko for tilskadekomst.

- ▶ Sørg for at sikre beholderen, så den ikke falder ned.



- 1.8 **Kun AXEO HydroControl (HC):**
Afmontér omdrejningssensoren.
Du finder sensoren på højre side af drivenheden.

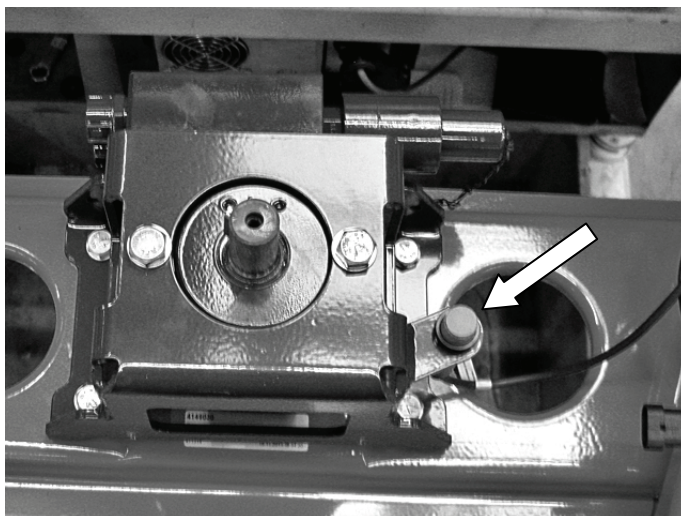

- 1.9 **Kun AXEO HydroControl (HC):**
Løsn proportionalventilens
stikforbindelse.

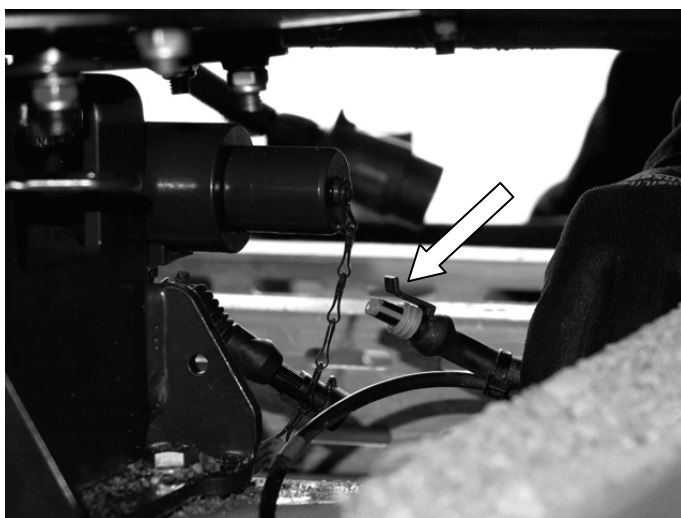



- 1.10 Løsn drivenhedens forskruring, bortskaf bolte og møtrikker.
Møtrikkerne er selvlåsende og må kun bruges én gang.
Et nyt sæt bolte, møtrikker og skiver til fastgørelse af drivenheden er vedlagt omstillingssættet.





- 1.11 Tag hele drivenheden (konsol, motor, spredeskive osv.) ud.

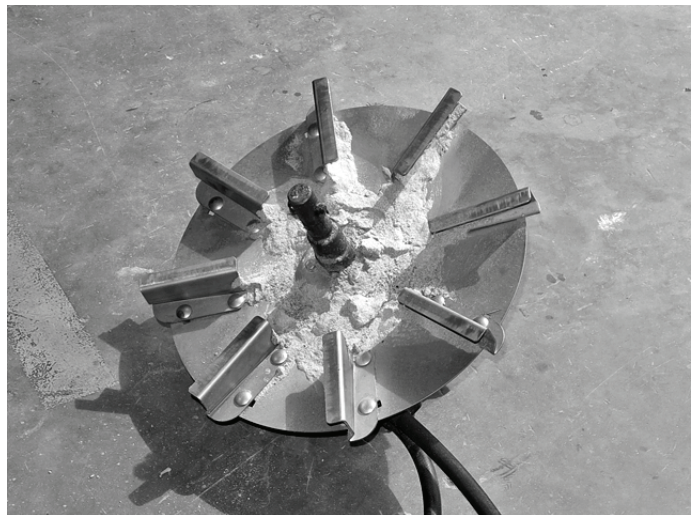
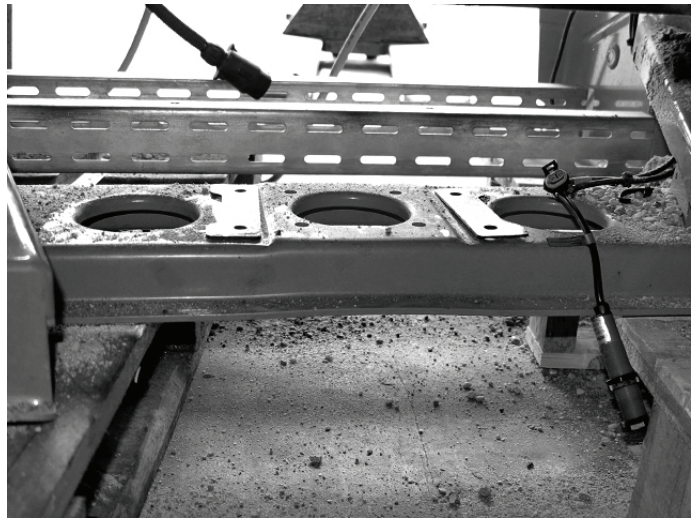

- 1.12 Tag afstandspladerne af rammen, og opbevar dem til senere brug.
Afstandspladerne bruges til tilpasning af drevet.

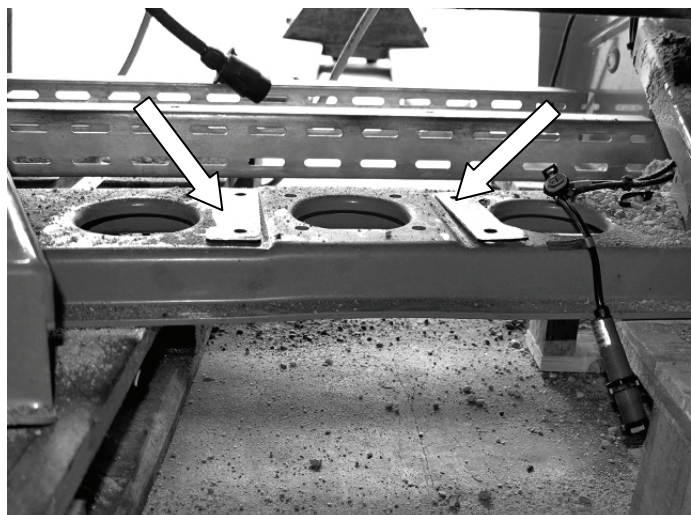



2. Demontering af drivenheden

- 2.1 Løsn spredeskiven fra drivenheden, og bortskaf boltene.
Disse bolte er selvlåsende og må kun bruges én gang.
Et nyt sæt bolte til fastgørelse af spredeskiven er vedlagt omstillingssættet.



- 2.2 Tag spredeskiven af drivenheden.





- 2.3 Fjern gevindtappen (M8) fra røreværksakslen.

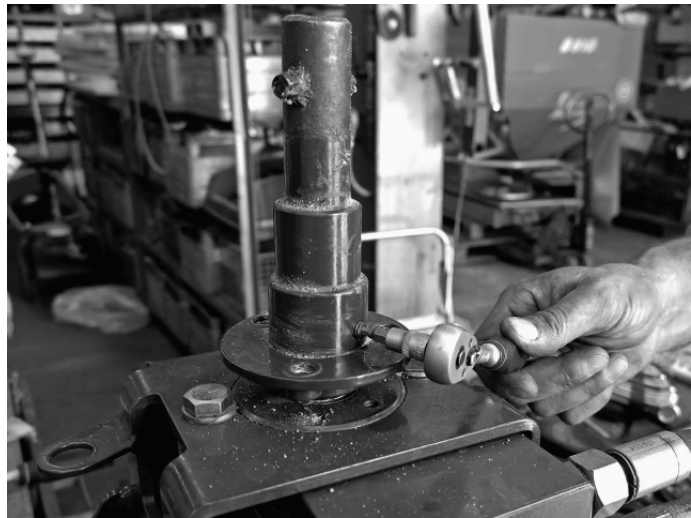

- 2.4 Mærk den gamle røreværksaksel op 43 mm over dens nederste kant.

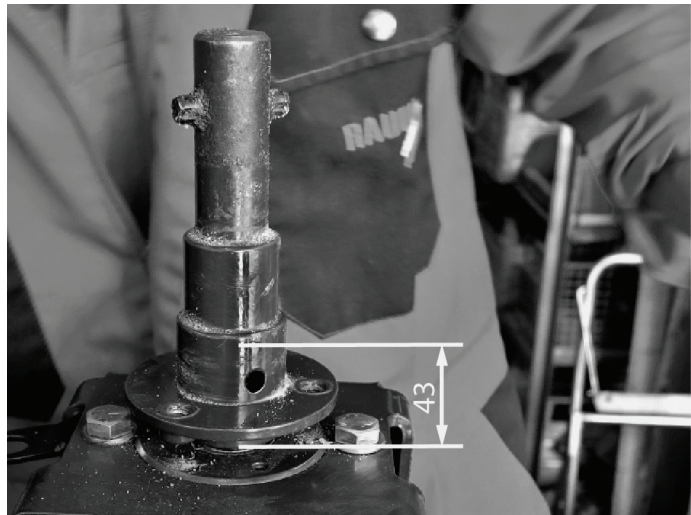



- 2.5 Afkort den gamle røreværksaksel en smule mere end en savklingetykkelse over de opmærkede 43 mm.



- 2.6 Træk den nederste del af den gamle røreværksaksel af motorakslen.

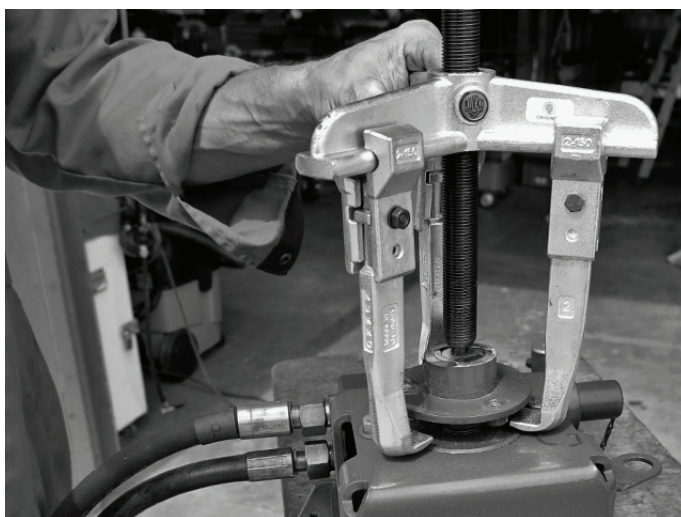



- 2.7 Afmonter motoren, og bortskaf bolte og møtrikker.
Møtrikkerne er selvlåsende og må kun bruges én gang.
Et nyt sæt bolte, møtrikker og skiver til fastgørelse af drivenheden er vedlagt omstillingssættet.



- 2.8 Bortskaf den gamle drivkonsol.

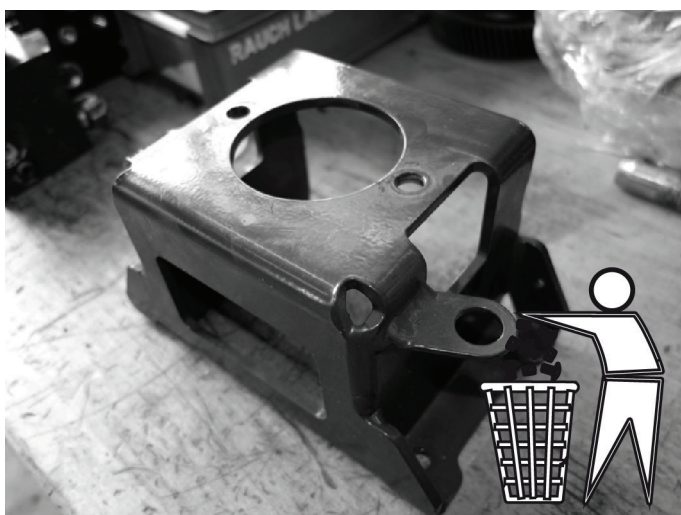



3. Sammenbygning af drivenheden

3.1 Læg bolte, møtrikker og skiver til fastgørelse af motoren parat i drivkonsollen.

Boltene og skiverne er vedlagt omstillingssættet.

Billedtekst

- a) Sekskantbolt M12 x 45
- b) Skive
- c) Sekskantmøtrik M12 (selvlåsende)

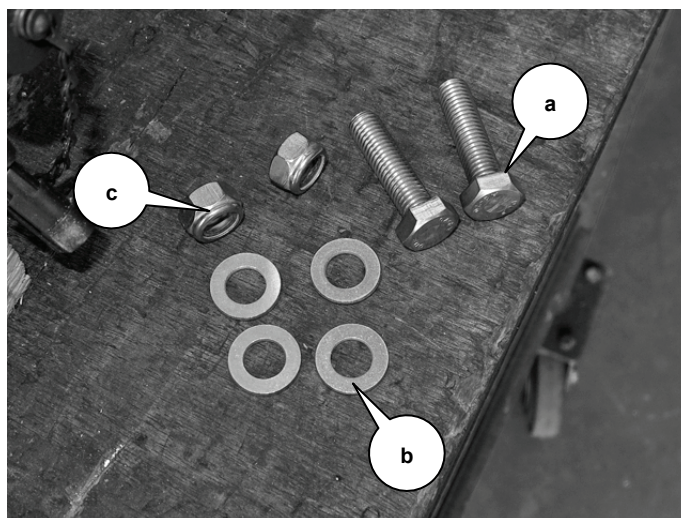

3.2 Skru motoren i den nye drivkonsol, tilspændingsmoment 70 Nm.

Billedtekst

- a) Sekskantbolt M12 x 45
- b) Skive
- c) Sekskantmøtrik M12 (selvlåsende)

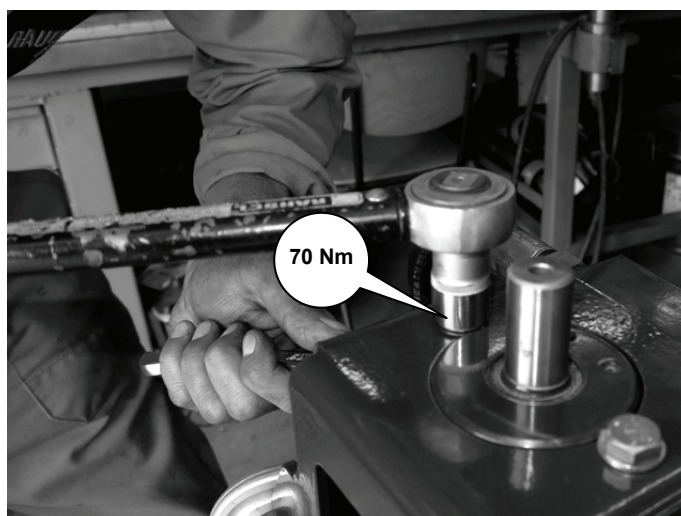
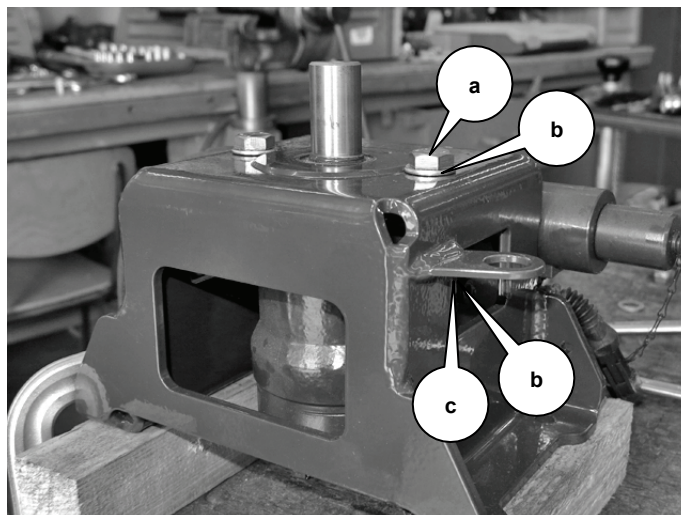



3.3 Smør motorakslen med fedt.



3.4 Skær de tre gevind til spredskiveholderen på røreværksakslen.
Under lakeringen kan der komme lak ind i hullerne og tilstoppe gevindet.



3.5 Smør røreværksakslen med fedt **indvendigt**, også hullet til gevindtappen.





- 3.6 Ret hullet til gevindtappen og noten i røreværksakslen til i forhold til motorakslens pasfeder.

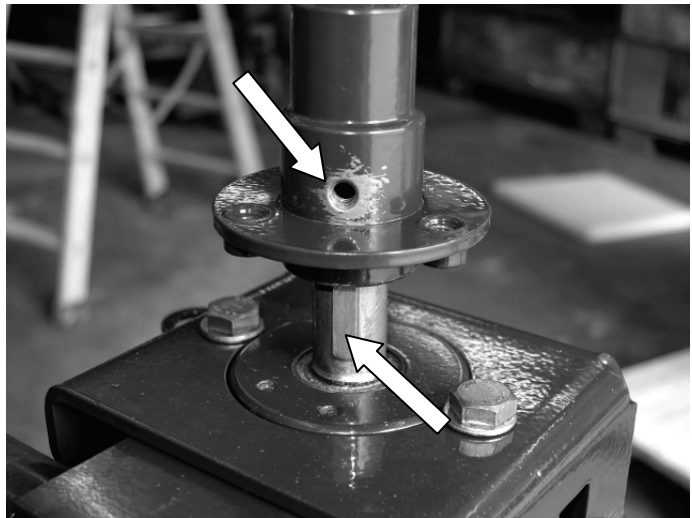

- 3.7 Pres røreværksakslen på ved hjælp af en kunststofhammer.



- 3.8 Skru gevindtappen i, og klem røreværksakslen fast.





3.9 Sæt spredeskiven på røreværksakslen.



3.10 Læg de tre selvlåsende bolte og skiverne til spredeskiven parat. *Boltene og skiverne er vedlagt omstillingssættet.*

Billedtekst

- a) Sekskantmøtrikker M8 x 20 (selvlåsende)
- b) Skiver

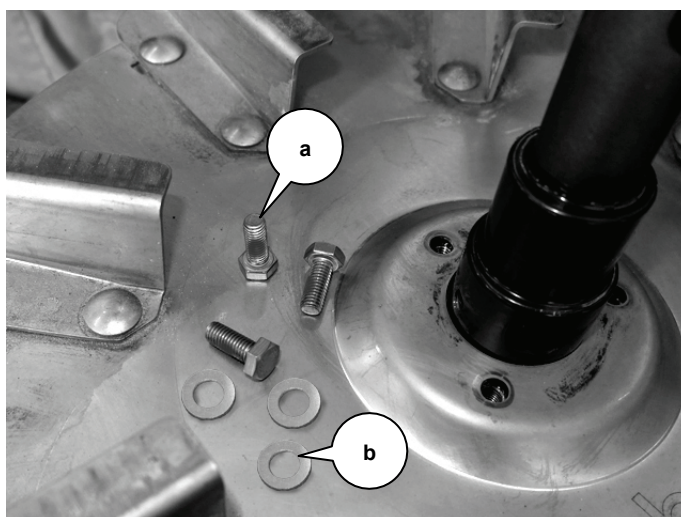

3.11 Skru spredeskiven fast. **Tilspændingsmoment 22 Nm.**

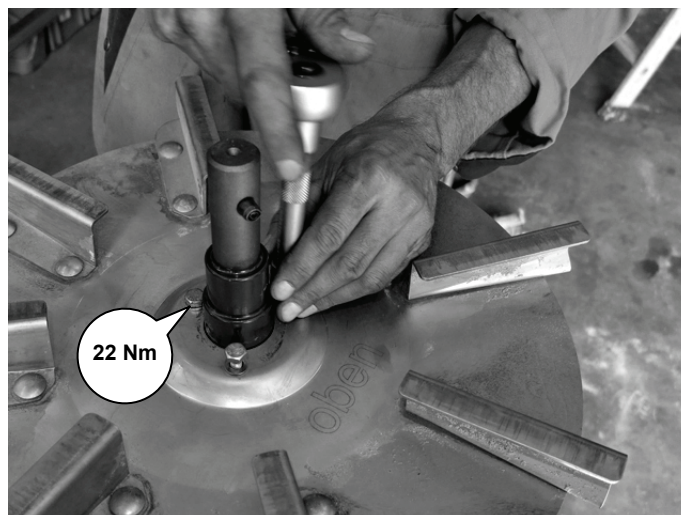



4. Indbygning af drivenheden

- 4.1 Læg sekskantboltene, sekskantmøtrikkerne, skiverne og afstandspladerne til indbygning af konsollen parat.

Afstandspladerne bruges til tilpasning af beholder og ramme resp. røreværksdrev.

Billedtekst

- a) Skiver
- b) Afstandsplader
- c) Sekskantmøtrikker M10
- d) Sekskantbolte M10 x 30

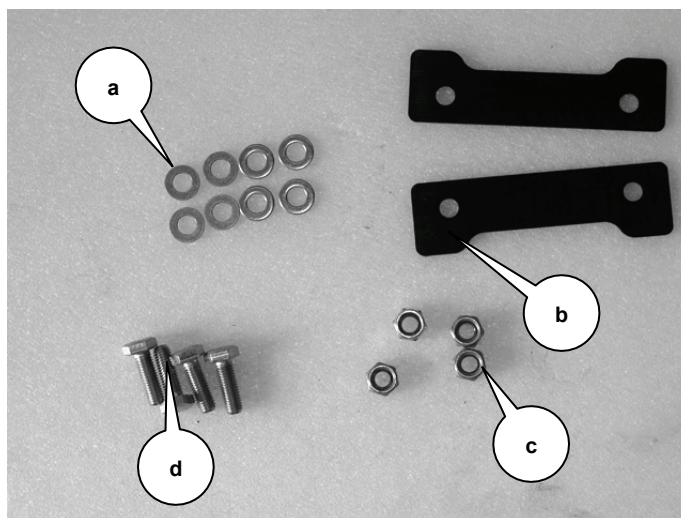

- 4.2 Montér drivenheden, **tilspændingsmoment 60 Nm.**

Billedtekst

- a) Sekskantbolte M10 x 30
- b) Skiver
- c) Afstandsplader
- d) Sekskantmøtrikker M10

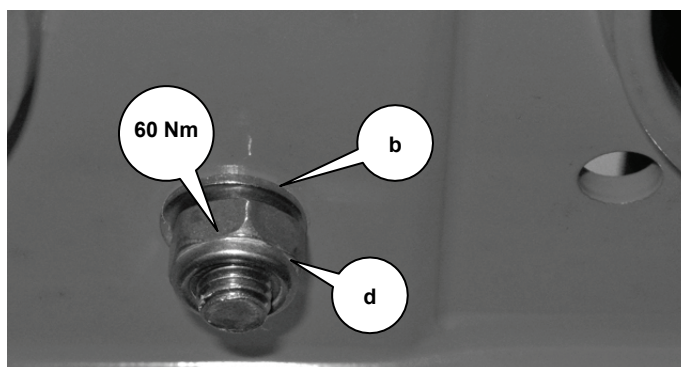
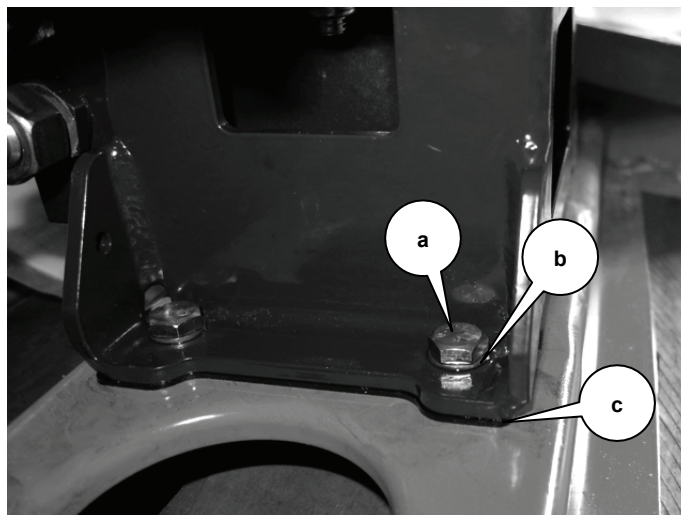



- 4.3 **Kun AXEO HydroControl (HC):**
Montér omdrejningssensoren.
*Afstanden mellem sensor og
holderskive: 3 til 5 mm*

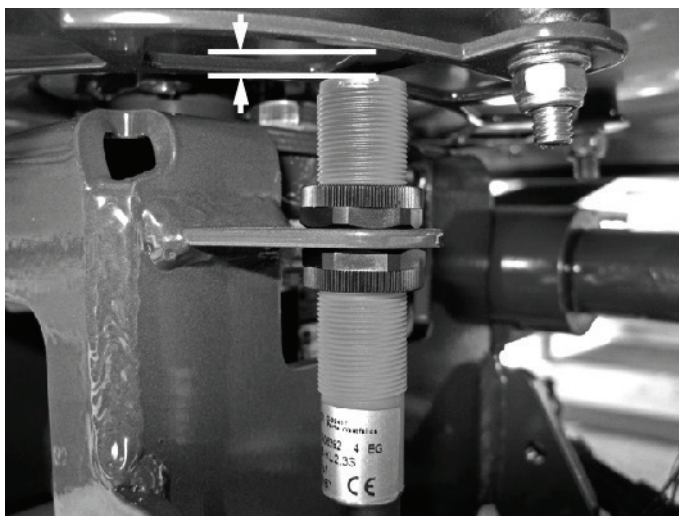

- 4.4 **Kun AXEO HydroControl (HC):**
Sæt proportionalventilens stik i
igen.

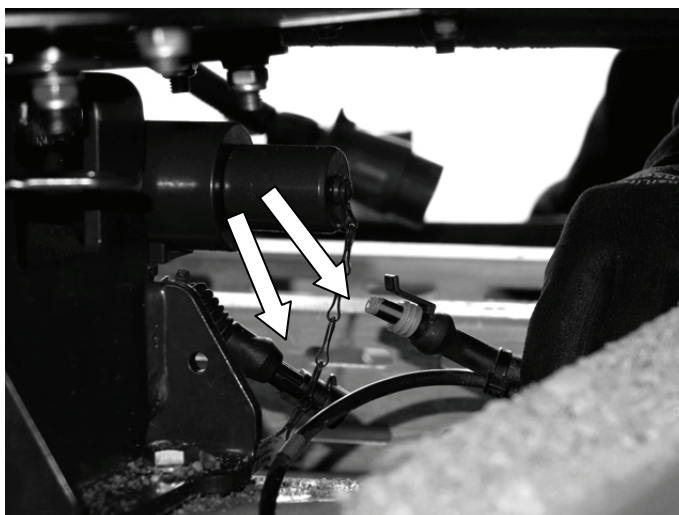

- 4.5 **Kun AXEO HydroControl (HC):**
Fastgør stikket til konsollen ved
hjælp af kabelbinder.

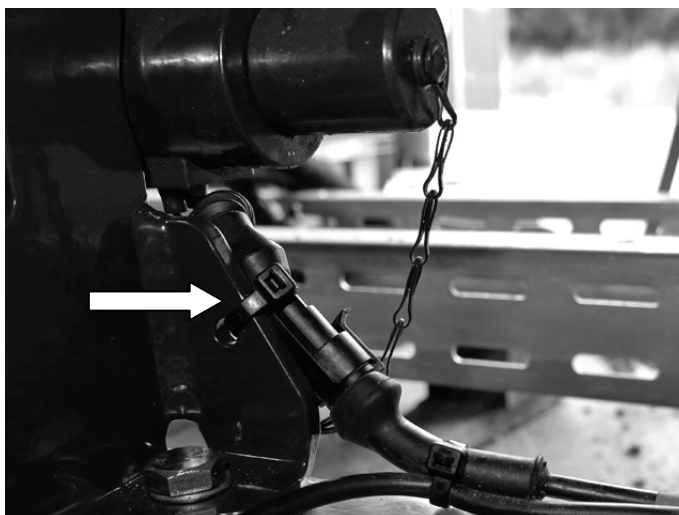



- 4.6 Løft beholderen op, og tag træstykkerne ud.



- 4.7 Sæt beholderen på rammen, og pas den til ved hjælp af mærkerne.

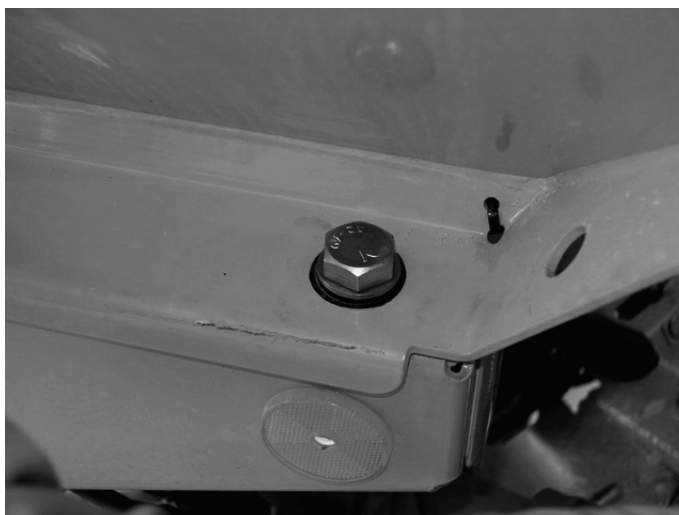



- 4.8 Spænd beholderskruerne,
tilspændingsmoment: 120 Nm

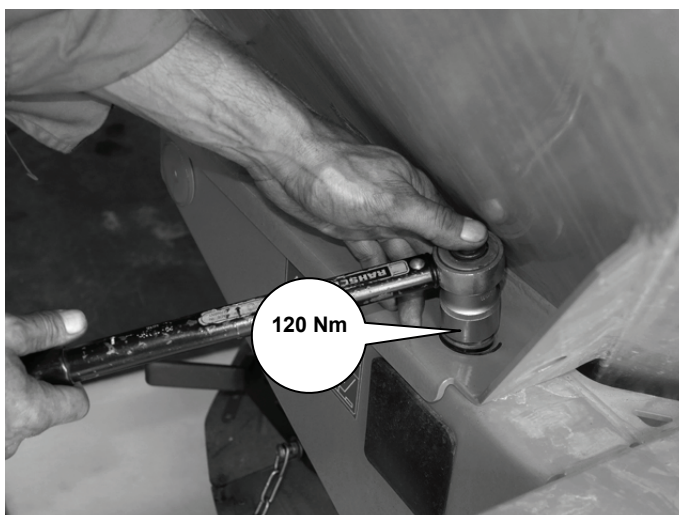

- 4.9 Fastgør begge belygningskabler
stramt på beholderen ved hjælp
af kabelbindere.





- 4.10 Sæt røreværket i igen.
Du kan finde yderligere oplysninger om indbygning af AXEO-røreværket i AXEO-driftsvejledningen, kapitel "Afmontage af røreværk".



- 4.11 Tag beholderen af kranen.



- 4.12 Kontrollér røreværkets aksiale spillerum og afstand til jorden.
Røreværket skal sidde på røreværksakslen med ca. 1 mm spillerum og kunne rotere frit.

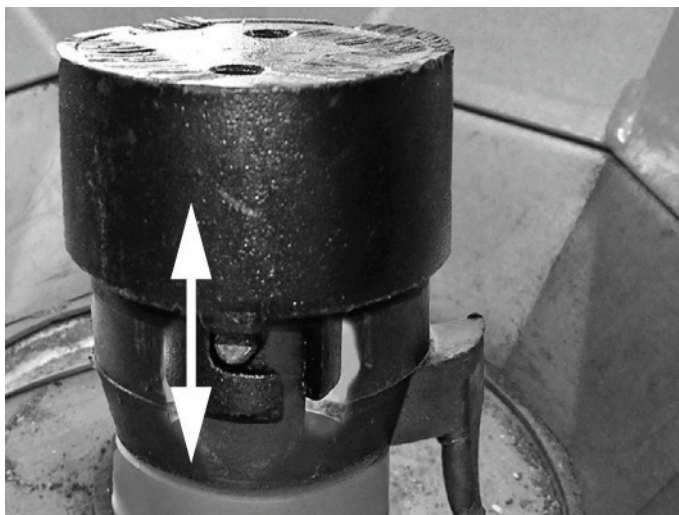



- 4.13 Hvis der er et spillerum, men det er mindre end 1 mm:

Fil lidt materiale af bajonettfatningen.

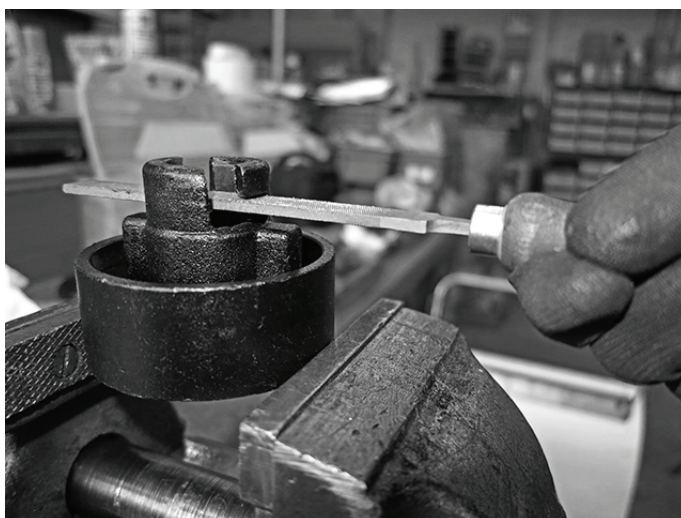

- 4.14 Hvis røreværket klemmer eller ikke kan monteres:

Læg ekstra afstandsskiver (2 mm) under drevet.

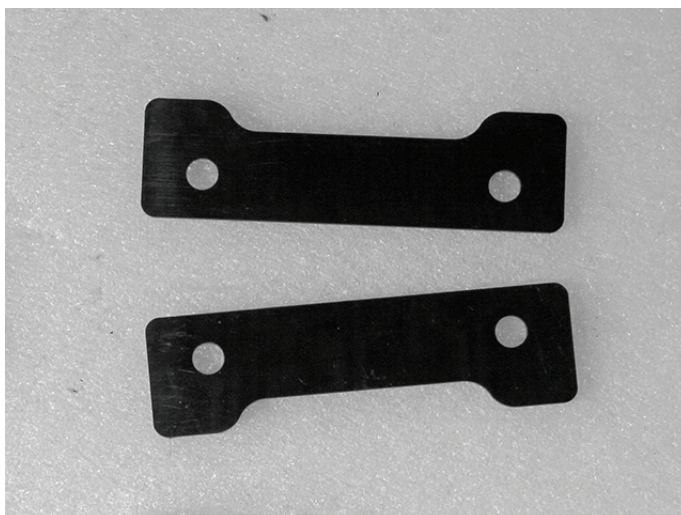

- 4.15 Kontrollér funktionen, og udfør en prøvekørsel.



Omstillingen er afsluttet, når funktionskontrollen og prøvekørslen er bestået.



Omstillingsæt AXEO





1. Avmontere drivenhet

- 1.1 Heng AXEO-beholderen på kranen.



- 1.2 Avmonter AXEO-røreverket.
Mer informasjon om avmontering av AXEO-røreverket finner du i AXEO-bruksanvisningen, kapittel "Demontere røreverk".



- 1.3 Fjern de to buntebåndene for belyningskabelen på høyre og venstre side.
Du finner de to buntebåndene på siden av beholderen, i nærheten av de fremre beholderskruene.





- 1.4 Marker posisjonen til beholderskruen foran til høyre og bak til venstre.

Disse markeringene gjør at du kan rette inn beholderen og rammen/røreverksdrivverket ved senere sammenmontering.



- 1.5 Løsne beholderskruene.





- 1.6 Legg klar to firkantbjelker med en høyde/bredde på min. 80 mm.



- 1.7 Løft beholderen litt opp, legg firkantbjelkene på rammen og senk ned beholderen.
La beholderen være innhengt!



⚠ ADVARSEL



Ulykkesfare!

Beholderen kan skubbes av rammen.
Fare for personskader.

- ▶ Sikre beholderen mot å falle av.



- 1.8 **Kun AXEO HydroControl (HC):**
Demonter turtallsensoren.
Du finner sensoren på høyre side av drivenheten.

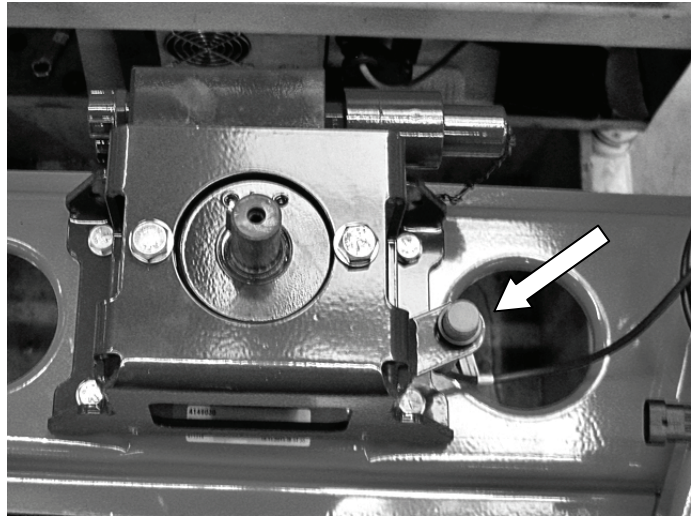

- 1.9 **Kun AXEO HydroControl (HC):**
Løsne pluggforbindelsene til proporsjonalventilen.

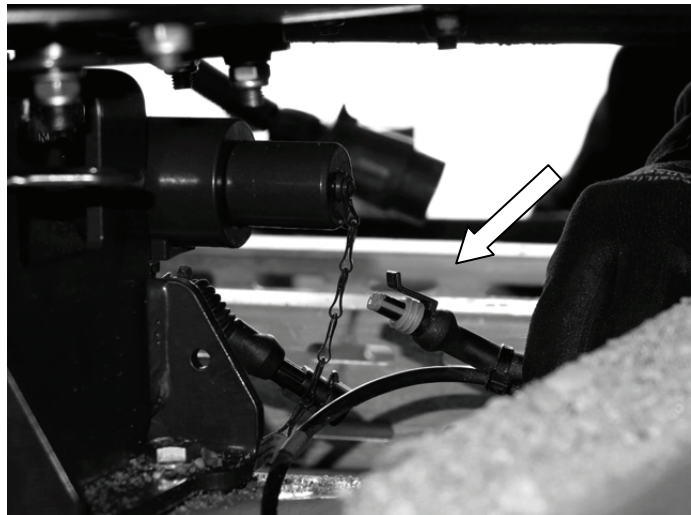



- 1.10 Løsne skrueforbindelser på drivenheten, kast skruer og mutre.

Mutrene er selvlåsende, og må kun brukes én gang.

Et nytt sett skruer, mutre og skiver for å feste drivenheten følger med omstillingssettet.





- 1.11 Ta ut hele drivenheten (konsoll, motor, kasteskive etc.).

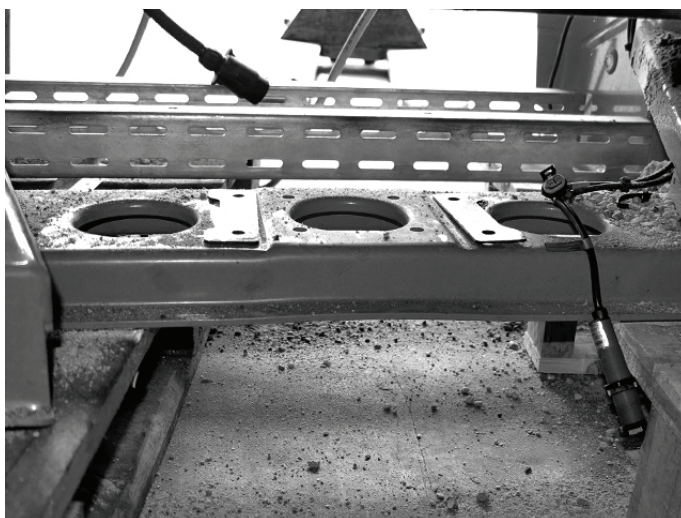

- 1.12 Ta avstandsplatene av rammen og ta vare på dem.
Avstandsplatene brukes til å rette inn drivverket.

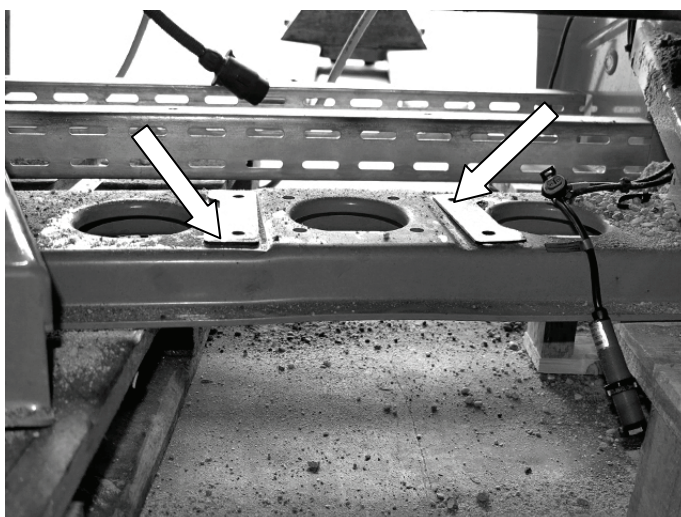



2. Demontere drivenheten

- 2.1 Løsne kasteskiven fra drivenheten, og kast skruene.
Disse skruene er selvlåsende, og må kun brukes én gang.
Et nytt sett skruer for å feste kasteskiven følger med omstillingssettet.



- 2.2 Ta kasteskiven av drivenheten.





- 2.3 Fjern pinneskruen (M8) fra røreverkakselen.

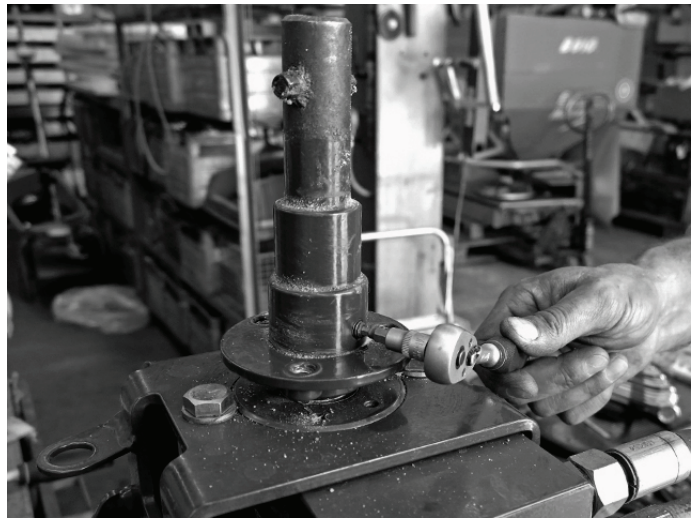

- 2.4 Riss et merke i den gamle røreverkakselen 43 mm over den nederste kanten.

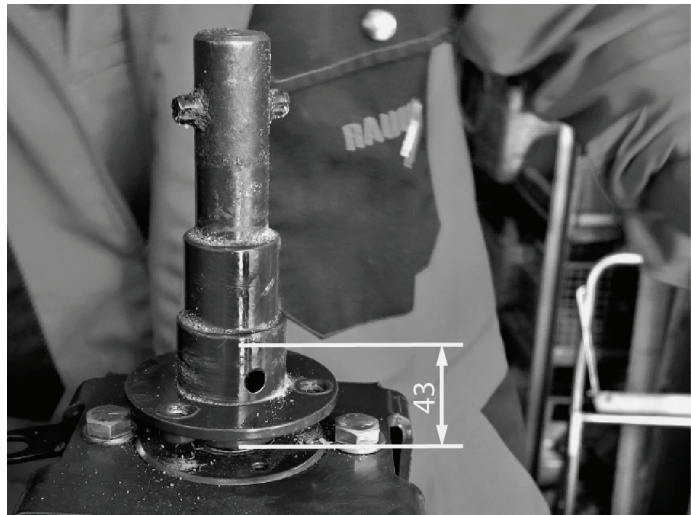



- 2.5 Kapp av den gamle røreverksakselen litt mer enn tykkelsen på en kappskive eller sagblad over den markerte 43 mm.



- 2.6 Trekk den nedre delen av den gamle røreverksakselen av motorakselen.

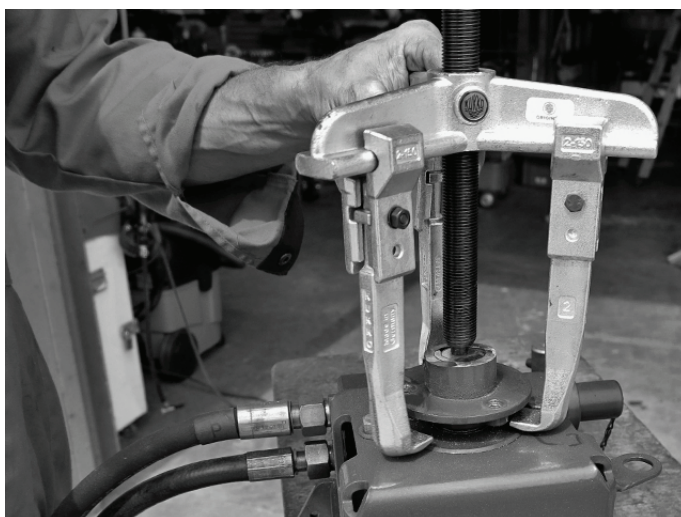



2.7 Avmonter motoren, og kast skruer og mutre.

Mutrene er selvlåsende, og må kun brukes én gang.

Et nytt sett skruer, mutre og skiver for å feste drivenheten følger med omstillingssettet.



2.8 Kast den gamle drivverkkonsollen.

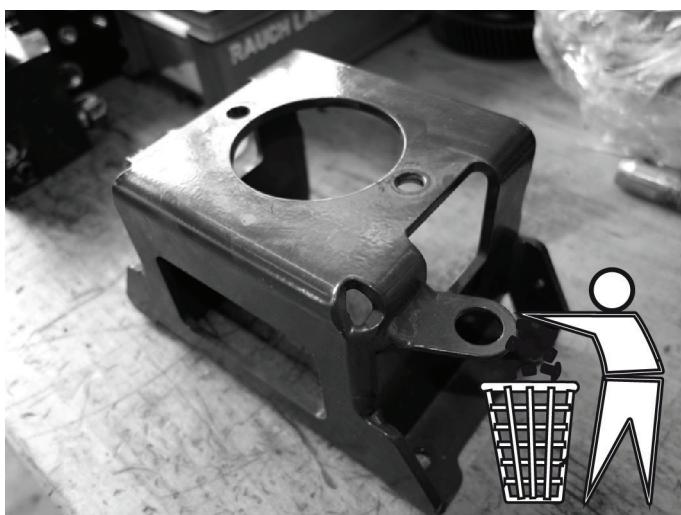



3. Sammenmontere drivenhet

3.1 Legg klar skruer, mutre og skiver til å feste motoren i drivverkkonsollet.

Skrue og skivene følger med i omstillingssettet.

Forklaring illustrasjon

- a) Sekskantskrue M12 x 45
- b) Skive
- c) Sekskantmutter M12 (selvlåsende)

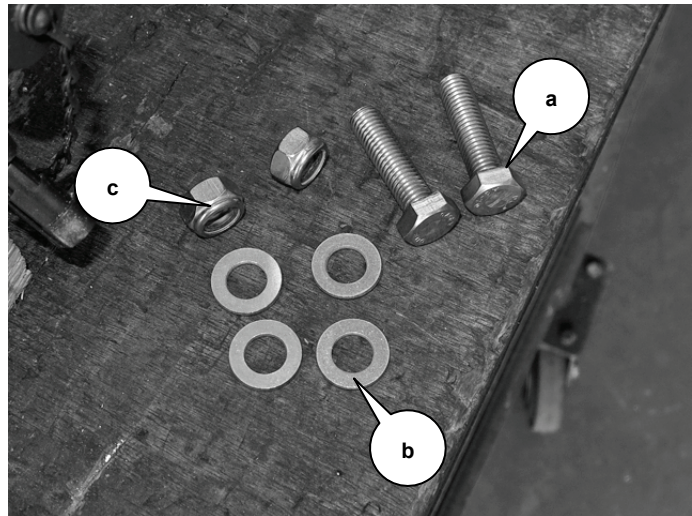

3.2 Skru motoren inn i det nye drivverkkonsollet, **tiltrekkingsmoment 70 Nm.**

Forklaring illustrasjon

- a) Sekskantskrue M12 x 45
- b) Skive
- c) Sekskantmutter M12 (selvlåsende)

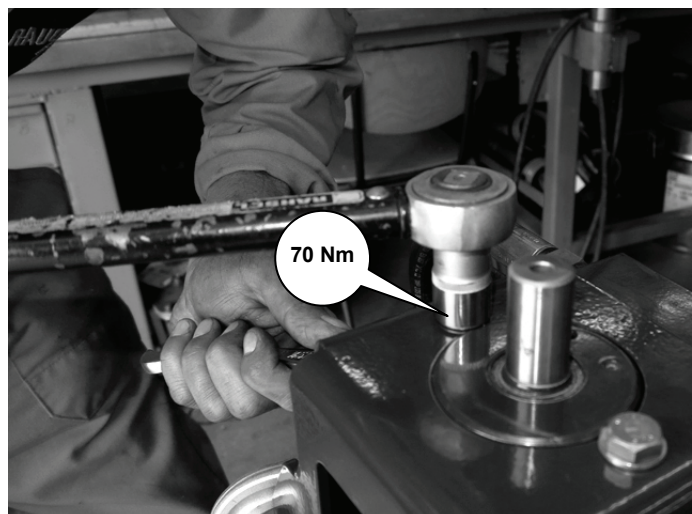
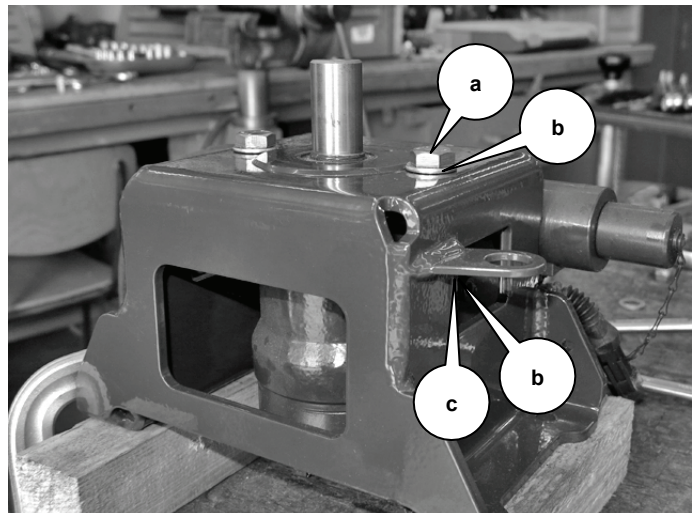



- 3.3 Smør motorakselen med fett.

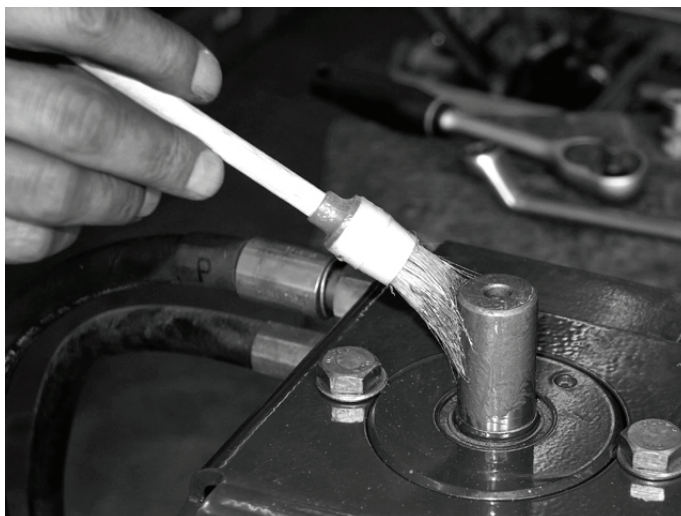

- 3.4 Etterskjær de tre skruegangene for kasteskiveholderen på den nye røreverkakselen.
Ved lakkering kan det komme lakk inn i hullene og tette til gjengene.



- 3.5 Smør røreverkakselen med fett **innvendig**, inkludert hullet til pineskruen.





- 3.6 Rett inn hullet til pinneskruen / kilesporet i røreverkakselen etter passkilen på motorakselen.

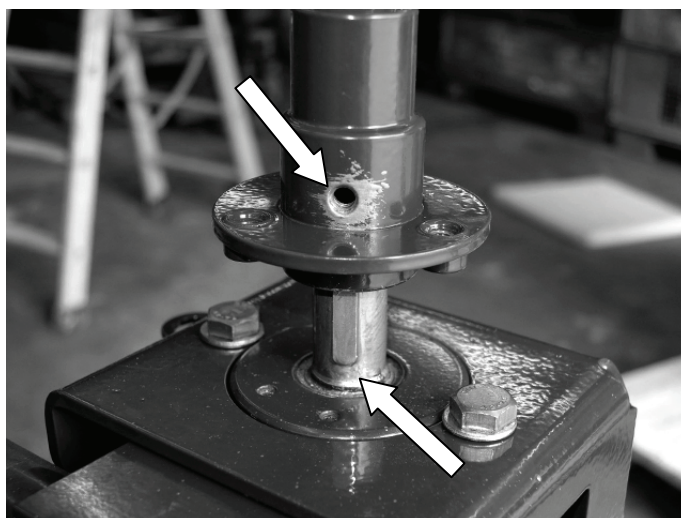

- 3.7 Føy sammen røreverkakselen med et plasthammer.



- 3.8 Skru inn pinneskruen, klem fast røreverkakselen.





- 3.9 Sett kasteskiven på røreverkakselen.



- 3.10 Legg klar de tre selvåsende skruene og skivene for kasteskiven.
Skrue og skivene følger med i omstillingssettet.

Forklaring illustrasjon

- a) Sekskantskruer M8 x 20 (selvåsende)
- b) Skiver

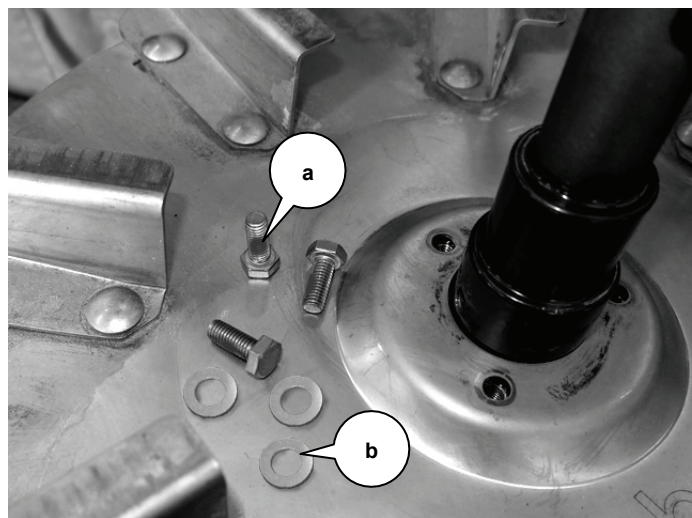

- 3.11 Skru fast kasteskiven.
Tiltrekkingsmoment 22 Nm.

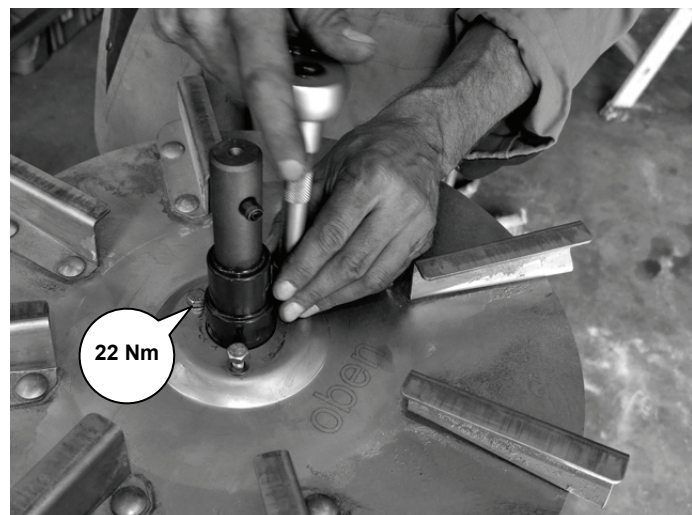



4. Montere drivenhet

- 4.1 Legg klar sekskantskruene, sekskantmutrene, skivene og avstandsplatene for monteringen av konsollen.

Avstandsplatene brukes til å rette inn beholder og ramme/røreverkdrivverk.

Forklaring illustrasjon

- c) Skiver
- a) Avstandsplater
- b) Sekskantmutre M10
- c) Sekskantskruer M10 x 30

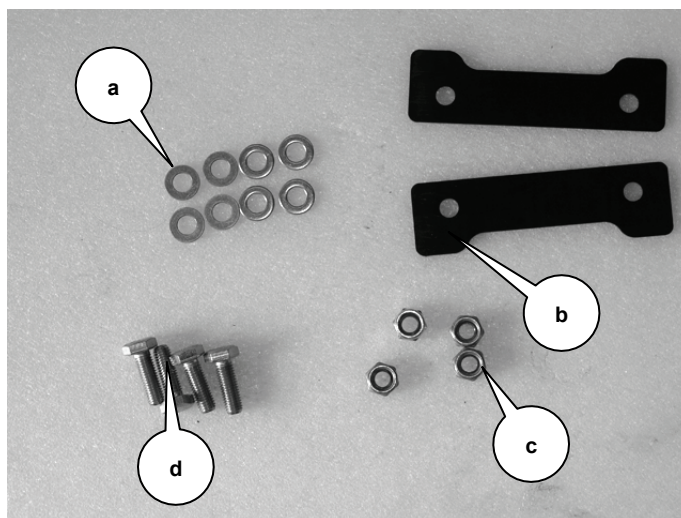

- 4.2 Monter drivenheten, tiltrekkingsmoment **60 Nm**.

Forklaring illustrasjon

- a) Sekskantskruer M10 x 30
- b) Skiver
- c) Avstandsplater
- d) Sekskantmutre M10

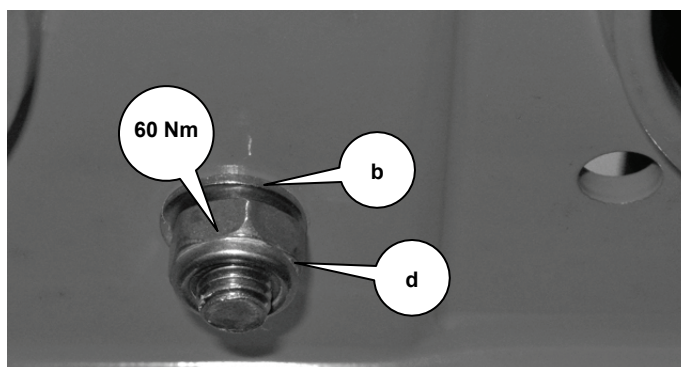
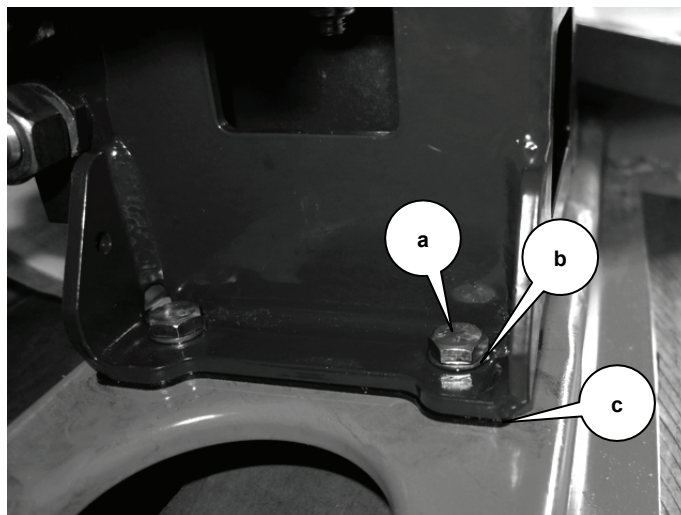



- 4.3 **Kun AXEO HydroControl (HC):**
Monter turtallsensoren.
*Avstand fra sensoren til
holderskiven: 3 til 5 mm*

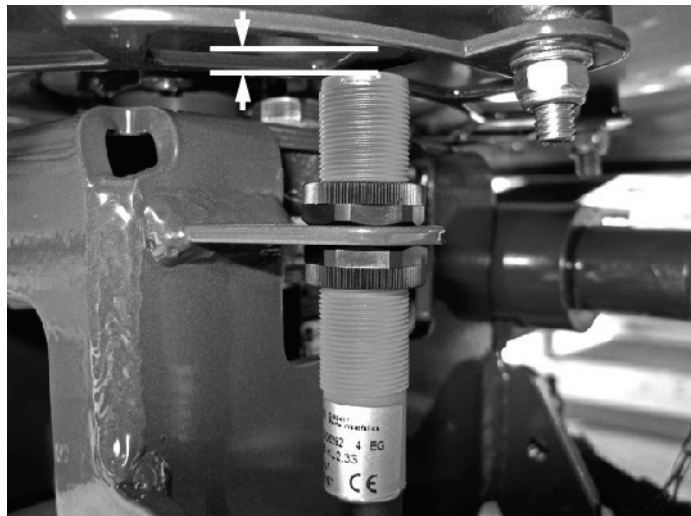

- 4.4 **Kun AXEO HydroControl (HC):**
Sett pluggen inn i
proporsjonalventilen igjen.

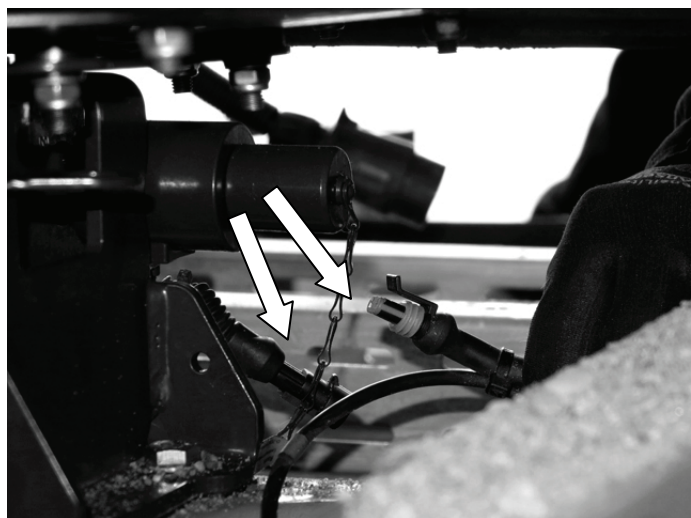

- 4.5 **Kun AXEO HydroControl (HC):**
Fest pluggen til konsollen med et
buntbånd.

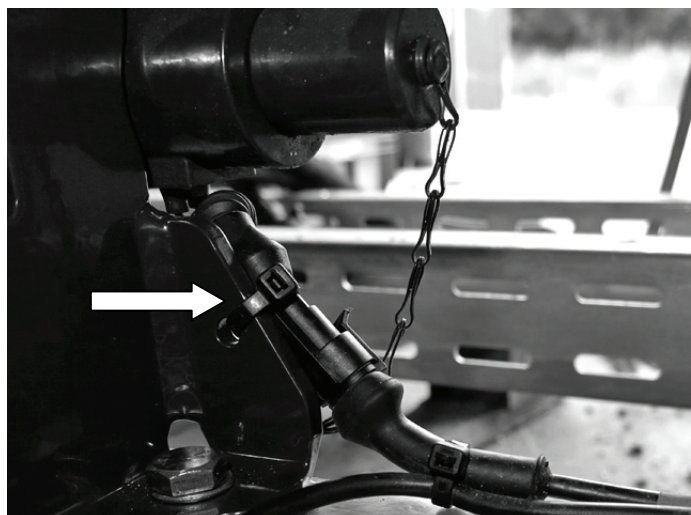



- 4.6 Løft opp beholderen og ta ut firkantbjelkene.



- 4.7 Sett beholderen på rammen, og rett inn ved hjelp av markeringene.

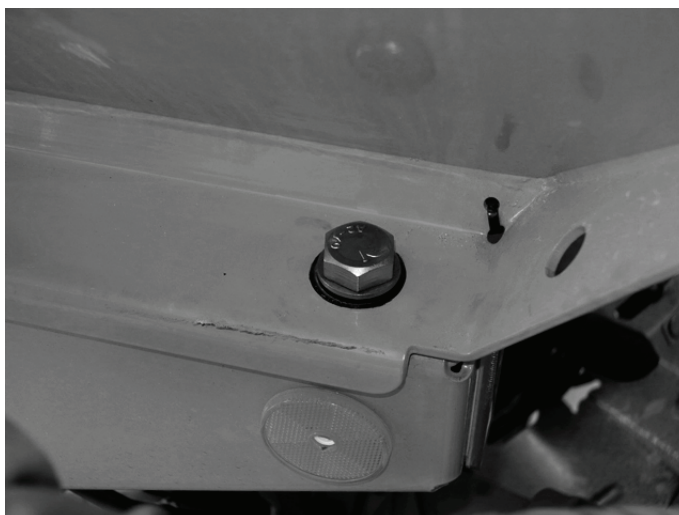



- 4.8 Stram beholderskruene,
tiltrekkingsmoment: 120 Nm

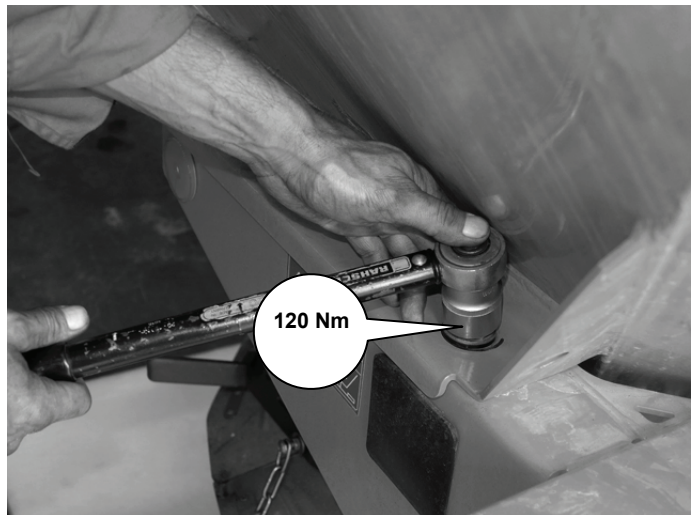

- 4.9 Fest belysningskabelen stramt til
beholderen med et buntbånd.

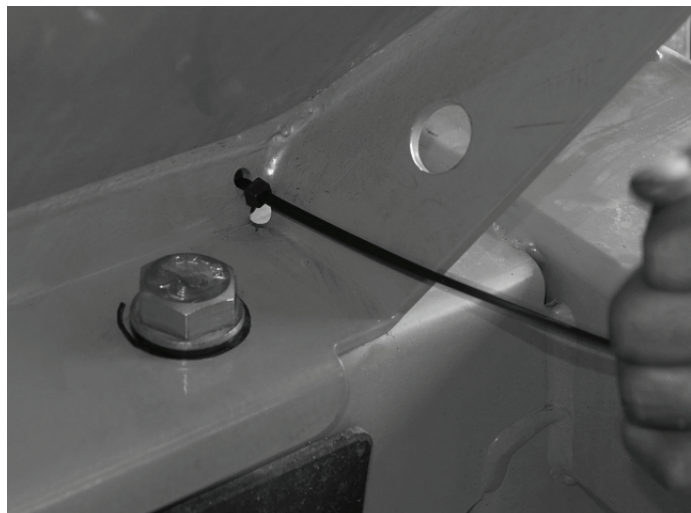



- 4.10 Monter røreverket igjen.
Mer informasjon om montering av AXEO-røreverket finner du i AXEO-bruksanvisningen, kapittel "Demontere røreverk".



- 4.11 Ta beholderen av kranen.



- 4.12 Kontroller aksialklaring og avstand fra røreverket til bunnen.
Røreverket må ha ca. 1 mm klaring til røreverkakslingen og kunne dreie fritt.

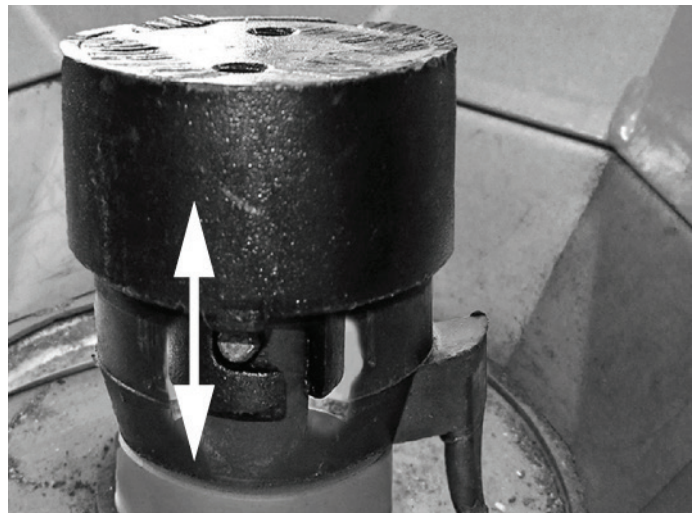



- 4.13 Hvis det er klaring, men dette er mindre enn 1 mm:

Fil av bajonetten.



- 4.14 Hvis røreverket klemmer eller det ikke er mulig å montere det:

Legg flere mellomleggsplater under giret (2 mm)

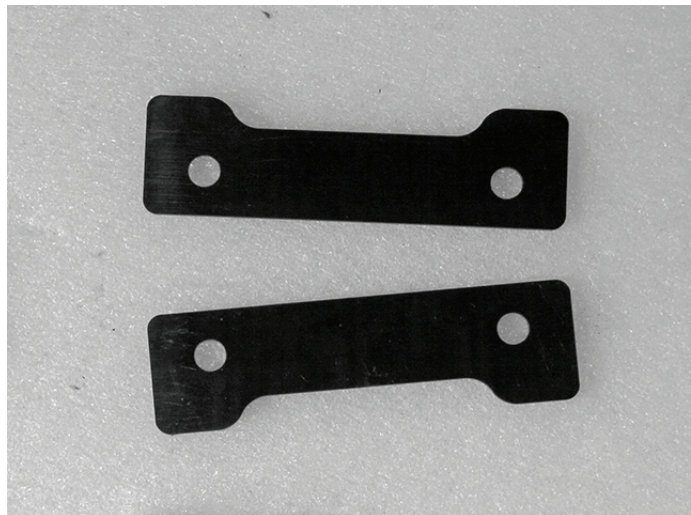

- 4.15 Kontroller funksjonen, gjennomfør prøvekjøring.

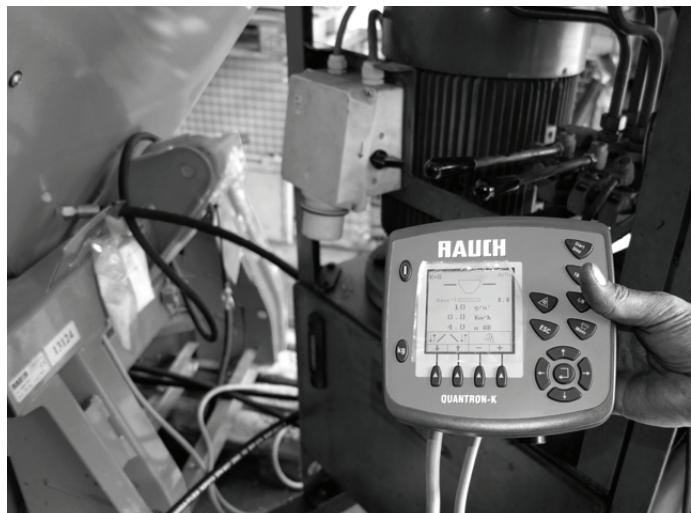

Når funksjonskontrollen/prøvekjøringen er gjennomført er omstillingen fullført.



Omstillingssett AXEO





1. Demontáž jednotky pohonu

- 1.1 Zavěste pevný obal AXEO na jeřáb.



- 1.2 Vymontujte míchačku AXEO.
Další informace o demontáži míchačky AXEO najdete v návodu k obsluze AXEO, kapitola „Demontáž míchačky“.



- 1.3 Odstraňte oba stahovací pásy pro kabel osvětlení na pravé a levé straně.
Oba stahovací pásy najdete na straně pevného obalu v blízkosti předních šroubů pevného obalu.





- 1.4 Označte polohy pravého předního a levého zadního šroubu pevného obalu.
Tyto značky vám při pozdější montáži pomohou vyrovnat pevný obal a rám, resp. pohon míchačky.



- 1.5 Povolte šrouby pevného obalu.





- 1.6 Připravte si dva čtyřhranné špalíky o výšce, resp. šířce min. 80 mm.



- 1.7 Nadzvedněte pevný obal, položte čtyřhranné špalíky na rám a spusťte pevný obal dolů.
Nechte pevný obal zavěšený!



⚠ VAROVÁNÍ



Nebezpečí úrazu!

Pevný obal může spadnout z rámu.
Možnost zranění.

- Zajistěte pevný obal proti pádu.



- 1.8 **Jen AXEO HydroControl (HC):**
Demontujte snímač otáček.
Snímač najdete na pravé straně jednotky pohonu.

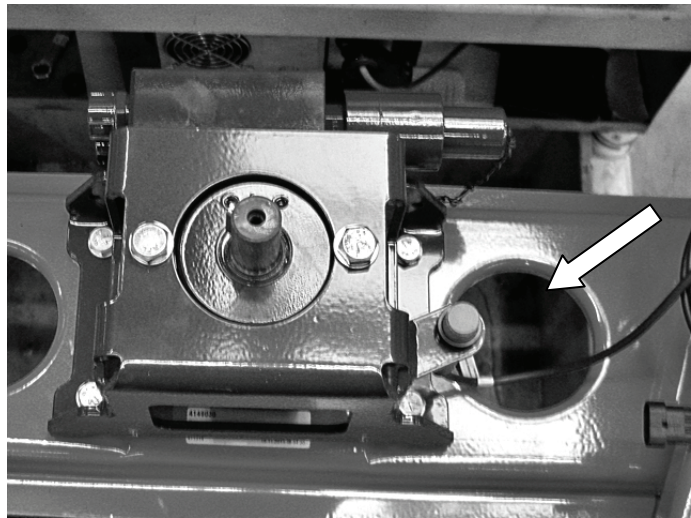

- 1.9 **Jen AXEO HydroControl (HC):**
Uvolněte konektor
proporcionálního ventilu.

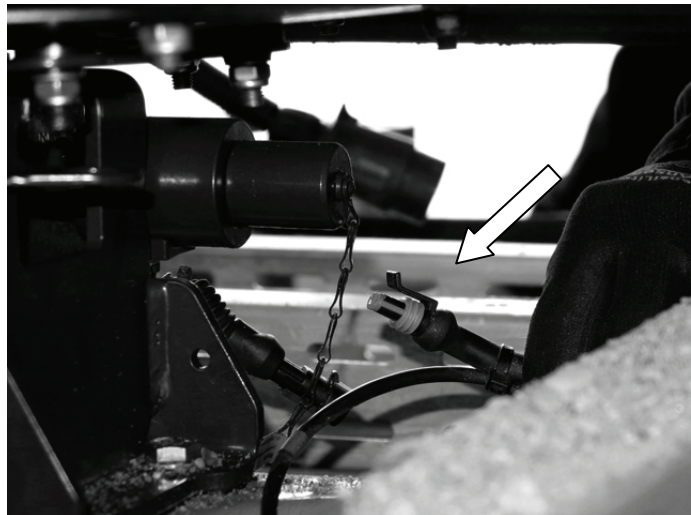



- 1.10 Povolte šroubení na jednotce pohonu a zlikvidujte šrouby a matice.

Matice jsou samosvorné a smí se použít jen jednou.

Nová sada šroubů, matic a podložek pro upevnění jednotky pohonu je součástí sady pro přestavbu.





- 1.11 Vyměňte celou jednotku pohonu (konzola, motor, rozmetací disk atd.).

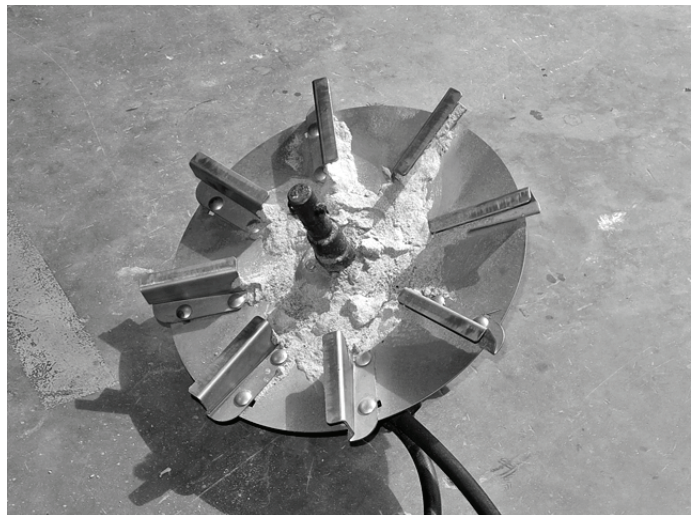
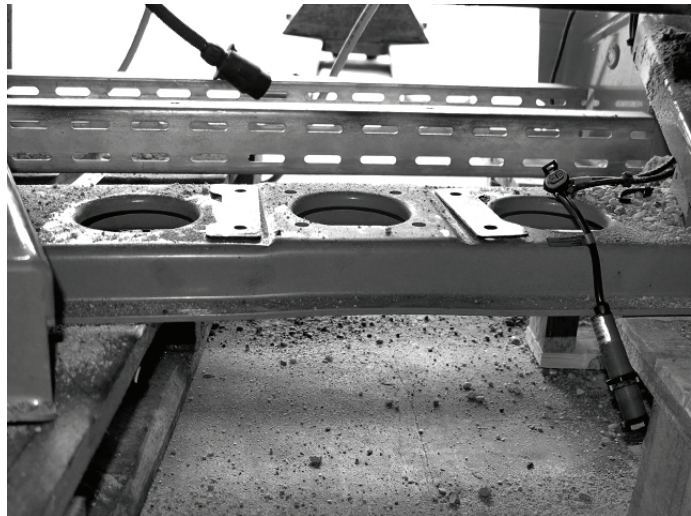

- 1.12 Odstraňte distanční desky z rámu a uložte.
Distanční desky slouží k vyrovnání pohonu.

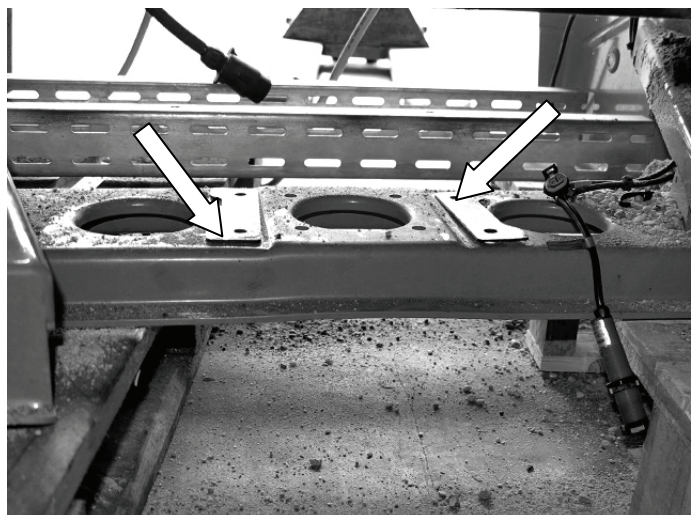



2. Demontáž jednotky pohonu

- 2.1 Uvolněte rozmetací disk z jednotky pohonu a zlikvidujte šrouby.

Tyto šrouby jsou samosvorné a smí se použít jen jednou.

Nová sada šroubů pro upevnění rozmetacího disku je součástí sady pro přestavbu.



- 2.2 Odstraňte rozmetací disk z jednotky pohonu.





- 2.3 Odstraňte závitový kolík (M8) z hřídele míchačky.

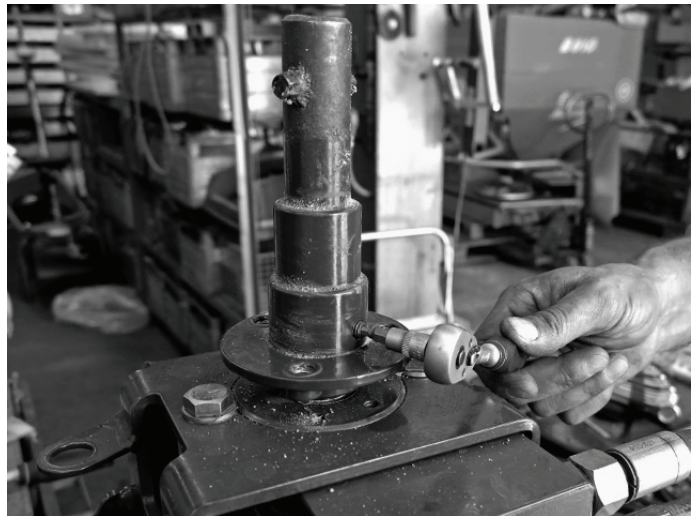

- 2.4 Nařízněte starý hřídel míchačky 43 mm nad jeho spodním okrajem.

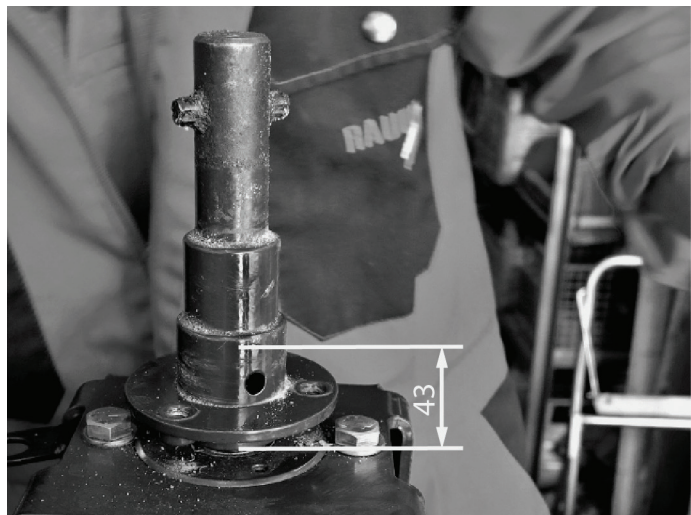



- 2.5 Oddělte starý hřídel míchačky o něco více než na tloušťku řezacího kotouče nad naříznutými 43 mm.



- 2.6 Stáhněte spodní díl starého hřídele míchačky z hřídele motoru.

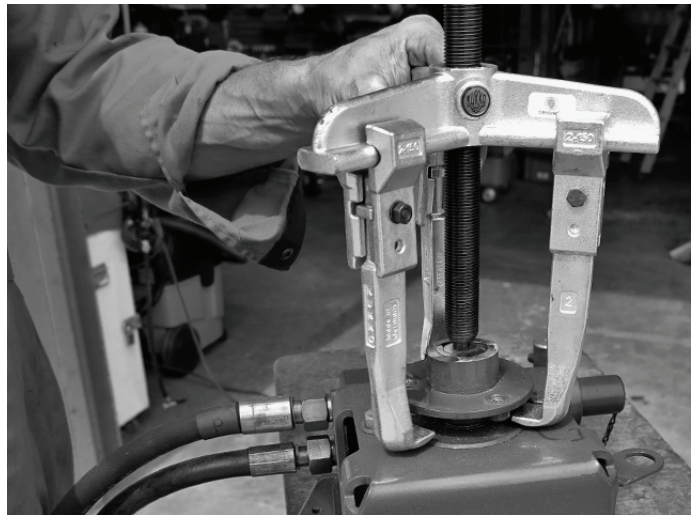



- 2.7 Vymontujte motor a zlikvidujte šrouby a matice.
Matice jsou samosvorné a smí se použít jen jednou.
Nová sada šroubů, matic a podložek pro upevnění jednotky pohonu je součástí sady pro přestavbu.



- 2.8 Zlikvidujte starou konzolu pohonu.

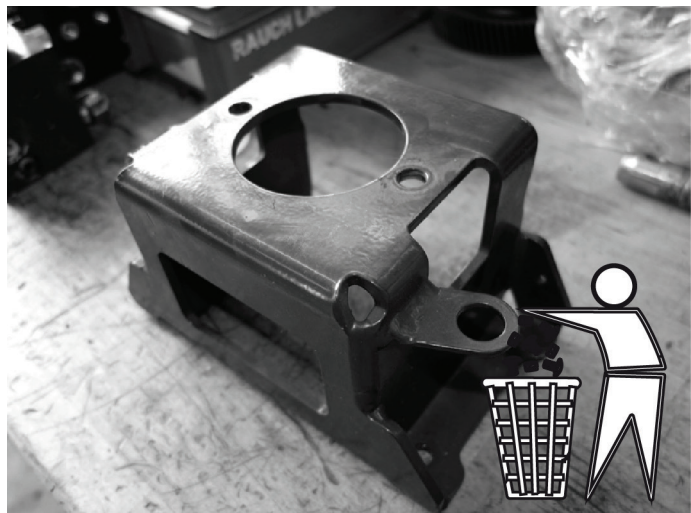



3. Smontování jednotky pohonu

3.1 Připravte si šrouby, matice a podložky pro upevnění motoru v konzole pohonu.

Šrouby a podložky jsou součástí sady pro přestavbu.

- a) Šroub se šestihrannou hlavou M12 x 45
- b) Podložka
- c) Šestihranná matice M12 (samosvorná)

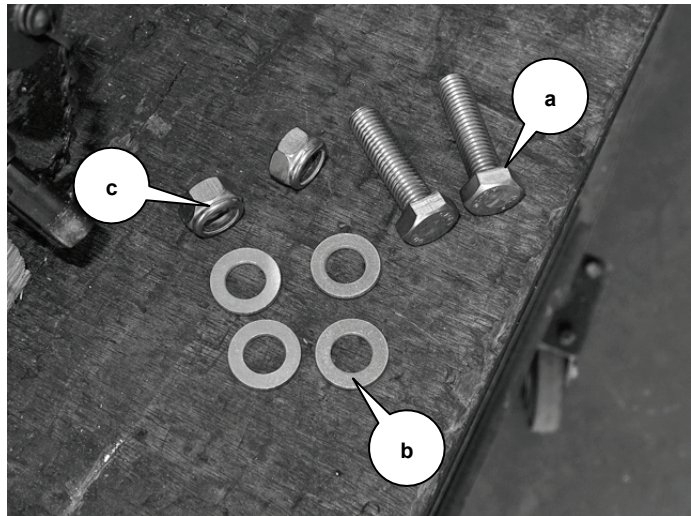

3.2 Našroubujte motor do nové konzoly pohonu, **utahovací moment 70 Nm.**

- a) Šroub se šestihrannou hlavou M12 x 45
- b) Podložka
- c) Šestihranná matice M12 (samosvorná)

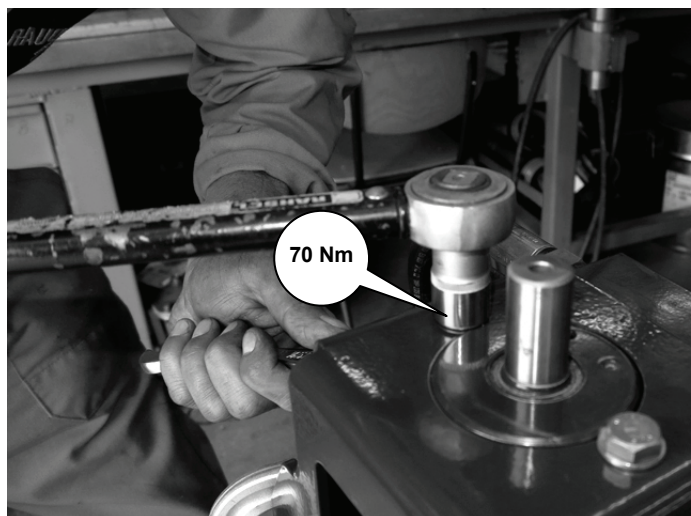
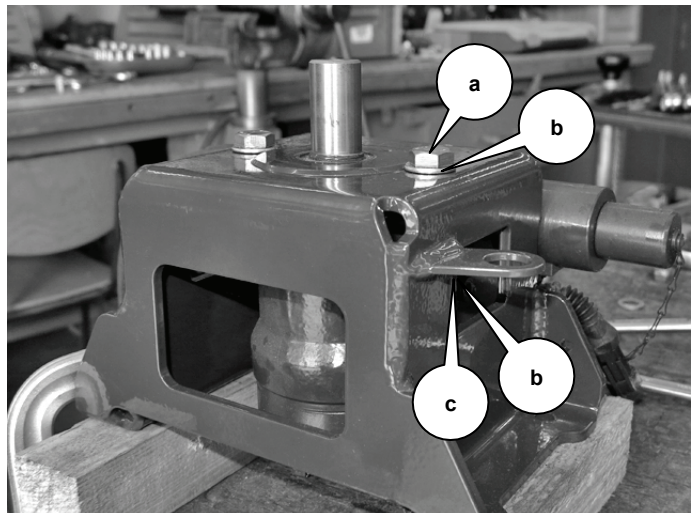



3.3 Namažte hřídel motoru.



3.4 Nařízňte tři závity pro upnutí rozmetacího disku na novém hřídeli míchačky.
Při lakování se může lak dostat do otvorů a zanést závity.



3.5 Namažte hřídel míchačky **uvnitř**, také namažte otvor pro závitový kolík.





- 3.6 Vyrovnajte otvor pro závitový kolík, resp. drážku v hřídeli míchačky na lícované pero hřídele motoru.

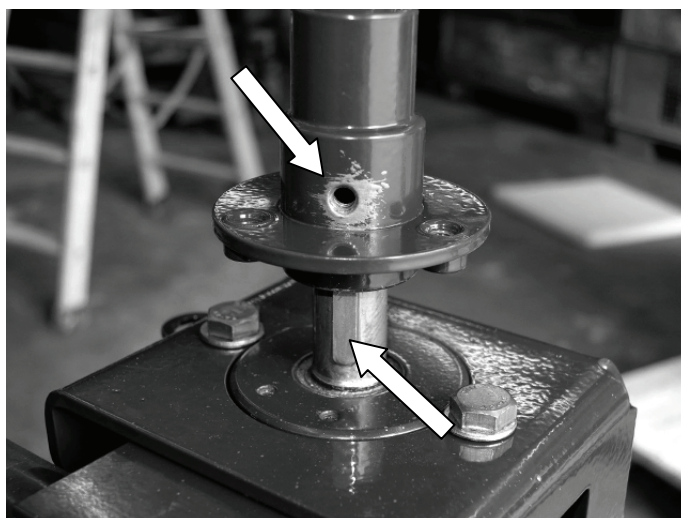

- 3.7 Zatlučte hřídel míchačky plastovým kladivem.



- 3.8 Zašroubujte závitový kolík a upněte hřídel míchačky.





3.9 Nasadte rozmetací disk na hřidel míchačky.



3.10 Připravte si tři šrouby se samopojistkou a podložkami pro rozmetací disk.
Šrouby a podložky jsou součástí sady pro přestavbu.

- a) Šrouby se šestihřannou hlavou M8 x 20 (samosvorné)
- b) Podložky

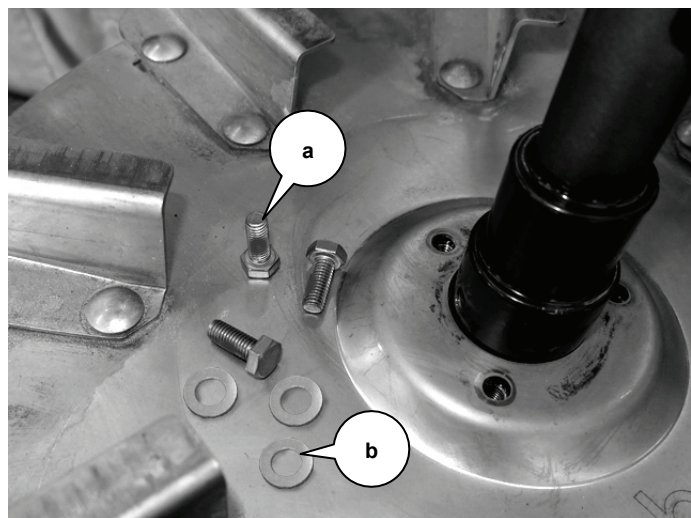

3.11 Přišroubujte rozmetací disk.
Uťahovací moment 22 Nm.

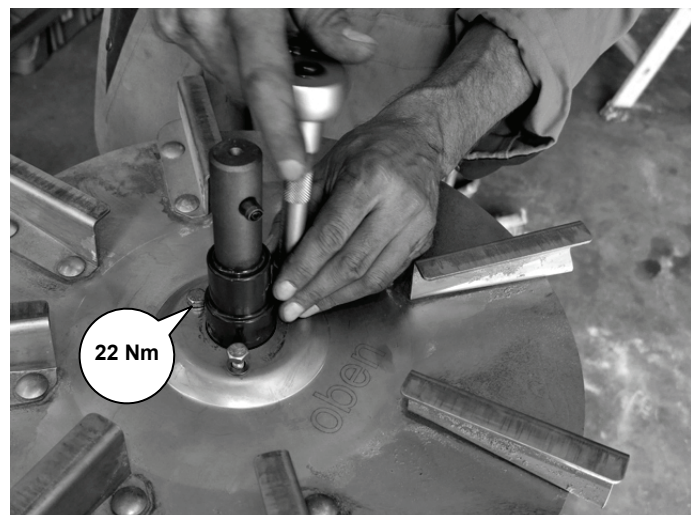



4. Montáž jednotky pohonu

4.1 Připravte si šrouby se šestihrannou hlavou, šestihranné matice, podložky a distanční desky pro montáž konzoly.

Distanční desky slouží k vyrovnání pevného obalu a rámu, resp. pohonu míchačky.

- a) Podložky
- b) Distanční desky
- c) Šestihranné matice M10
- d) Šrouby se šestihrannou hlavou M10 x 30

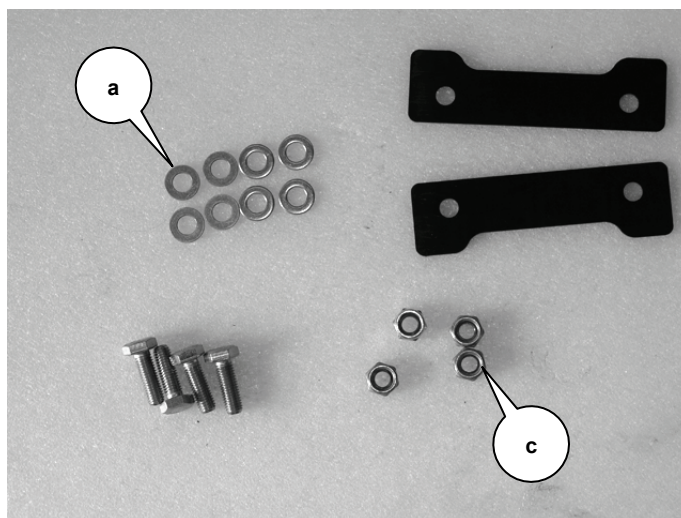

4.2 Namontujte jednotku pohonu, **utahovací moment 60 Nm.**

- a) Šrouby se šestihrannou hlavou M10 x 30
- b) Podložky
- c) Distanční desky
- d) Šestihranné matice M10

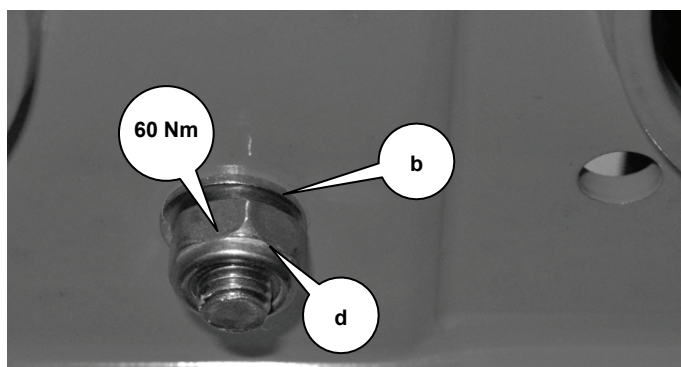
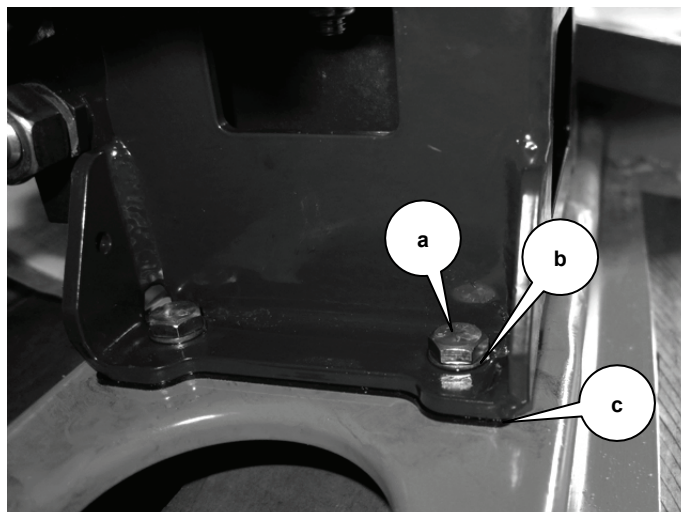



- 4.3 **Jen AXEO HydroControl (HC):**
Namontujte snímač otáček.
Vzdálenost snímače od kotouče:
3 až 5 mm

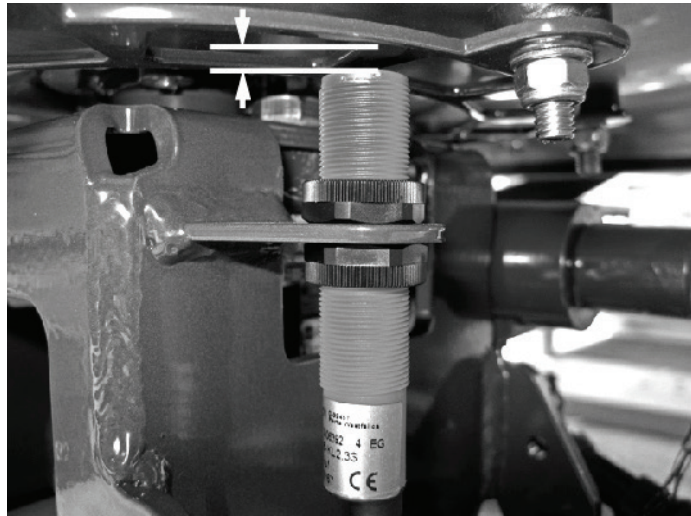

- 4.4 **Jen AXEO HydroControl (HC):**
Zapojte opět konektor
proporcionálního ventilu.

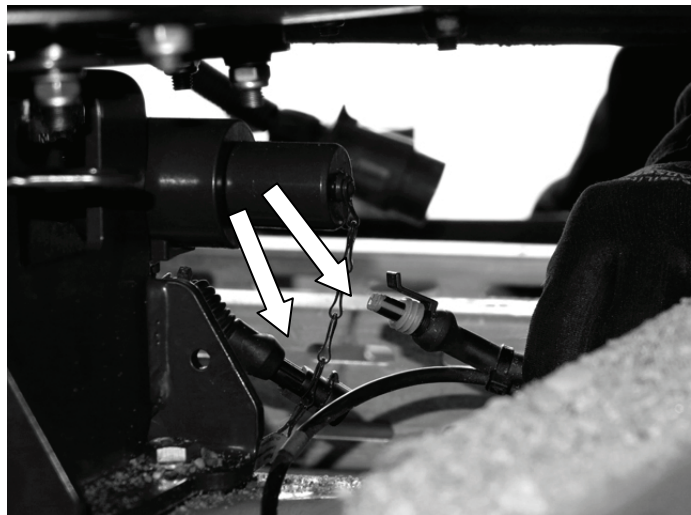

- 4.5 **Jen AXEO HydroControl (HC):**
Připevněte konektor stahovacím
páskem ke konzole.

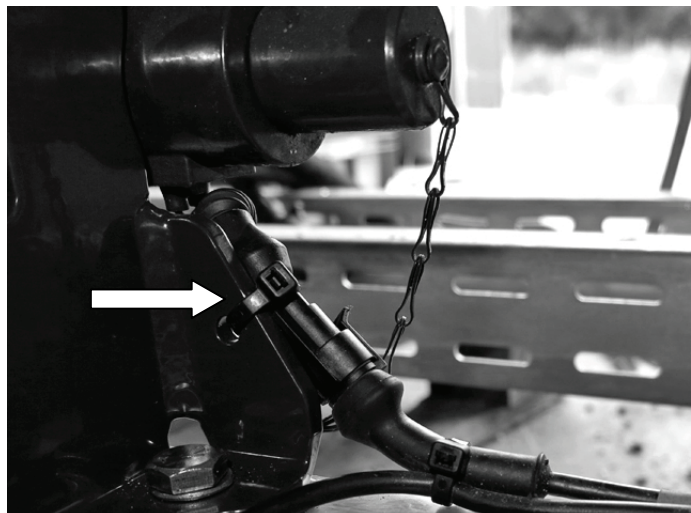



- 4.6 Nadzvedněte pevný obal a vyjměte čtyřhranné špalíky.



- 4.7 Nasadte pevný obal na rám a vyrovnejte podle značek.

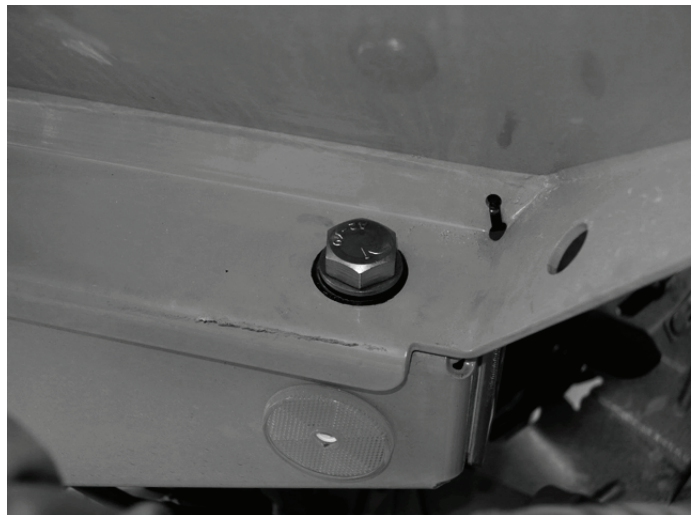



- 4.8 Utáhněte šrouby pevného obalu,
utahovací moment: 120 Nm

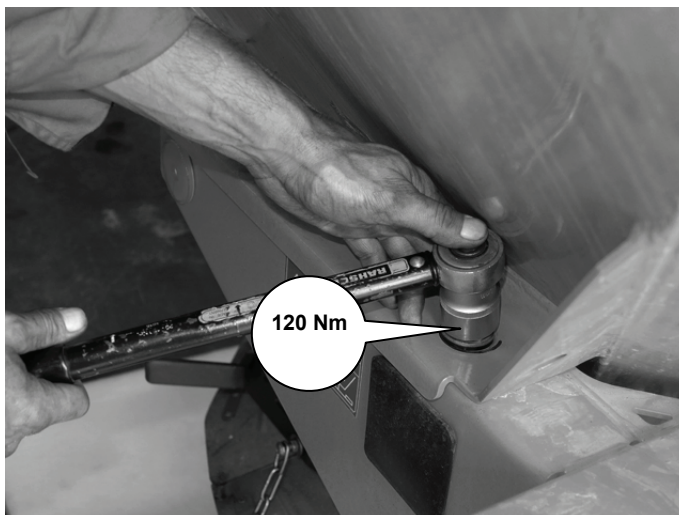

- 4.9 Silou připevněte oba kabely
osvětlení stahovacím páskem k
pevnému obalu.





- 4.10 Namontujte zpět míchačku.
Další informace o montáži míchačky AXEO najdete v návodu k obsluze AXEO, kapitola „Montáž míchačky“.



- 4.11 Sejměte pevný obal z jeřábu.



- 4.12 Zkontrolujte axiální vůli a odsazení míchačky ode dna.
Míchačka musí sedět cca 1 mm vůli na hřídeli míchačky a musí se s ní dát volně otáčet.

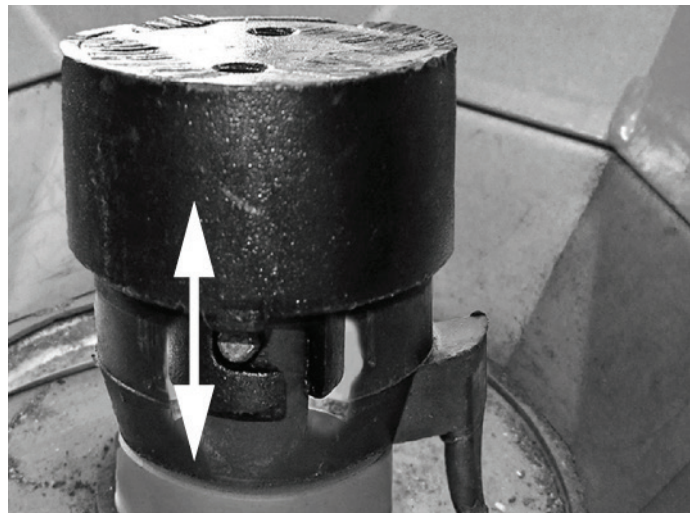



4.13 Pokud vůle existuje, ale je menší než 1 mm:

Uberte u bajonetu trochu materiálu.

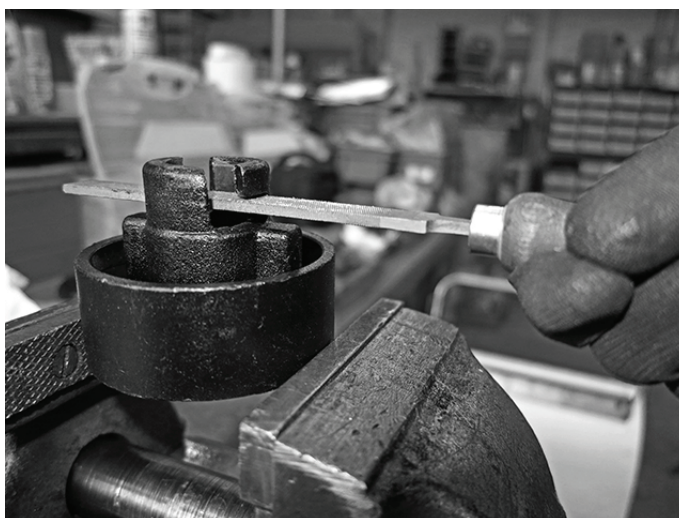

4.14 Pokud míchačka drhne nebo nelze namontovat:

Podložte pohon dalšími distančními podložkami (2 mm).



4.15 Zkontrolujte funkci a proveďte zkušební chod.

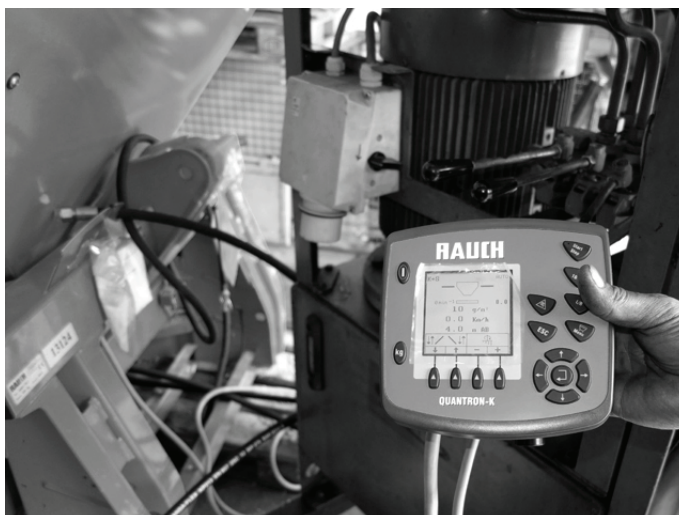

Při úspěšné funkční kontrole, resp. úspěšném zkušebním chodu je přestavba hotová.