

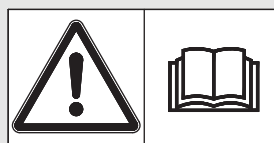

**RAUCH**

wir nehmen's genau

# INSTRUCTION MANUAL



**Please read carefully  
before using the ma-  
chine.**

Keep for future reference.

This instruction manual/assembly instruction is to be considered as part of the machine. Suppliers of new and second-hand machines are required to document in writing that the instruction manual/assembly instruction was delivered with the machine and handed over to the customer.

**QUANTRON-Guide**

Original instructions

5901216-**b**-en-0215

## Preface

Dear Customer

By purchasing the **control unit** QUANTRON-Guide for the AXIS and MDS mineral fertiliser spreaders, you have shown confidence in our product. Thank you very much! We want to justify your trust. You have purchased a reliable, high-performance **control unit**. However, in case unexpected problems arise: Our customer service is always there for you.

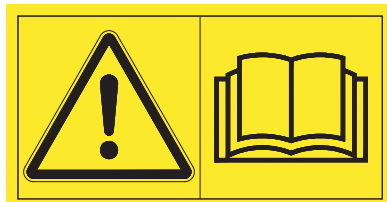

**Please read this operating manual as well as the operating manual of the machine carefully before commissioning and follow the advice given.**

This manual may also describe equipment that is not included in your **control unit**.

Please note that damage caused by incorrect operation or improper use may not be covered by warranty claims.

### HINWEIS

#### **Note the serial number of the control unit and of the machine**

The **QUANTRON-Guide** control unit has been calibrated at the factory for the mineral fertiliser spreader with which it was supplied. It cannot be connected to another machine without new calibration.

Please enter here the serial number of the control unit and of the machine. When connecting the control unit to the machine, these numbers are to be checked.

---

Control unit serial number:

---

Mineral fertiliser spreader  
serial number:

---

Year of manufacture:

## Technical improvements

**We are continuously improving our products. Therefore, we reserve the right to make any improvements and changes to our machine that we consider necessary without notice. This constitutes no obligation to make such improvements or changes on machines that have already been sold.**

We will be pleased to answer any other questions that you might have.

Yours sincerely

RAUCH

Landmaschinenfabrik GmbH

## Preface

Technical improvements

<b>1</b>	<b>User instructions</b>	<b>1</b>
1.1	About this operating manual . . . . .	1
1.2	Notes on the depiction of information in this manual. . . . .	1
1.2.1	Meaning of warnings . . . . .	1
1.2.2	Instructions and procedures. . . . .	3
1.2.3	Listings. . . . .	3
1.2.4	References. . . . .	3
1.2.5	Menu hierarchy, keys and navigation. . . . .	3
<b>2</b>	<b>Layout and function</b>	<b>5</b>
2.1	Overview of the supported mineral fertiliser spreaders . . . . .	5
2.2	Overview of compatible control units. . . . .	5
2.3	Layout of the control unit QUANTRON-Guide. . . . .	6
2.4	Control elements . . . . .	7
2.4.1	Overview . . . . .	7
2.4.2	Function keys. . . . .	8
2.4.3	Scroll wheel . . . . .	8
2.5	Display. . . . .	9
2.6	Library of symbols used. . . . .	10
<b>3</b>	<b>Attachment and installation</b>	<b>11</b>
3.1	Tractor requirements . . . . .	11
3.2	Power supply . . . . .	11
3.3	QUANTRON-Guide connection. . . . .	12

<b>4</b>	<b>Operation QUANTRON-Guide</b>	<b>15</b>
4.1	Control unit activation . . . . .	15
4.2	Machine settings . . . . .	16
4.2.1	Create new machine . . . . .	17
4.2.2	Changing machine settings . . . . .	18
4.2.3	Section adjustment (AXIS only) . . . . .	19
4.2.4	Machine profile activation . . . . .	20
4.3	Selection menu QUANTRON-Guide . . . . .	21
4.4	Transfer of OptiPoint settings (AXIS only) . . . . .	23
4.5	Navigation . . . . .	25
4.5.1	Create field . . . . .	25
4.5.2	Spreading with GPS Control . . . . .	27
4.6	Storage . . . . .	30
4.6.1	Saving field data . . . . .	30
4.6.2	Loading field data . . . . .	31
4.6.3	Deleting field data . . . . .	31
4.7	Information . . . . .	31
4.8	Saving the position of the GPS receiver . . . . .	32
<b>5</b>	<b>Alarm messages and possible causes</b>	<b>35</b>
5.1	Meaning of alarm messages . . . . .	35
5.2	Fault/alarm . . . . .	36
5.2.1	Acknowledging alarm messages . . . . .	36
	<b>Index</b>	<b>A</b>
	<b>Terms/conditions of warranty</b>	

# 1 User instructions

## 1.1 About this operating manual

This operating manual is an **integral part** of the control unit.

The manual contains important instructions for the **safe, proper** and **economic use** and **maintenance** of the control unit. Compliance with its stipulations helps to **avoid risks**, reduce maintenance costs and downtime and to increase the machine's reliability and service life.

The operating manual is an integral part of the machine. The entire documentation must be kept in an easily accessible location close to where the control unit is used (e.g. on the tractor).

The operating manual does not replace your **own responsibility** as the operator and operating personnel of the control unit.

## 1.2 Notes on the depiction of information in this manual

### 1.2.1 Meaning of warnings

The warning instructions in this manual have been structured according to the degree of danger and the probability of their occurrence.

Danger signs and symbols inform the user about other construction-related and unavoidable remaining dangers that may be encountered when operating the machine. The safety warnings are structured as follows:

<b>Signal word</b>	
Symbol	Explanation
<b>Example</b>	
<b>▲ DANGER</b>	
	<p><b>Description of the sources of danger</b></p> <p>Description of the danger and possible consequences.</p> <p>Ignoring these warnings will result in very serious or even fatal injury.</p> <p>► Measures to prevent the danger.</p>

**Warning severity level**

The degree of danger is indicated by the signal word. The levels are classified as follows:

**⚠ DANGER**



**Type of hazard and source of danger**

This advice warns of a danger posing an immediate threat to the health and life of persons.

Ignoring these warnings will result in very serious or even fatal injury.

- ▶ Always observe the measures described to prevent this danger.

**⚠ WARNING**



**Type of hazard and source of danger**

This advice warns of a possible dangerous situation for the health of persons.

Ignoring these warnings will result in very serious or even fatal injury.

- ▶ Always observe the measures described to prevent this danger.

**⚠ CAUTION**



**Type of hazard and source of danger**

This note warns of a potentially dangerous situation for personal health or of material and environmental damage.

Ignoring these warnings can result in damage to the product or the general area.

- ▶ Always observe the measures described to prevent this danger.

**NOTICE**

General information contain application tips and particularly useful information but neither warnings nor hazards.

---

## 1.2.2 Instructions and procedures

Steps that the operator must carry out are shown as a numbered list.

1. Instruction for action step 1
2. Instruction for action step 2

Instructions involving only one step are not numbered. The same applies for action steps that do not have a specific sequence.

A bullet is placed in front of these instructions:

- Handling instruction

## 1.2.3 Listings

Listings without a specific sequence are shown with bullet points (level 1) and dashes (level 2):

- Property A
  - Point A
  - Point B
- Property B

## 1.2.4 References

References to other text passages in the document are indicated with section number, headline text and page number:

- See also Chapter [3: Safety, page 5](#).

References to other documents are indicated as note or instruction without exact chapter or page number:

- Please also observe the instructions contained in the manual for the universal drive shaft.

## 1.2.5 Menu hierarchy, keys and navigation

The menus list **sub-menus** and/or **menu items** where settings can be made (selection lists, text or number entries, starting a function).

The various menus and function keys are illustrated in **bold** letters:

- Example: Open the **selection menu**.

The hierarchy and the path to the requested menu item are marked with > (arrow) between menu, sub-menu and the menu item:

- **Settings > General** means that the menu item **General** can be accessed via the menu **Settings**.
  - The arrow > corresponds to the operation of the **scroll wheel**.





## 2 Layout and function

### 2.1 Overview of the supported mineral fertiliser spreaders

Function/options	AXIS	MDS
Spreading depending on forward speed	<ul style="list-style-type: none"> <li>● AXIS-M 20.1 Q</li> <li>● AXIS-M 30.1 Q</li> <li>● AXIS-M 40.1 Q</li> </ul>	<ul style="list-style-type: none"> <li>● MDS 10.1 Q</li> <li>● MDS 11.1 Q</li> <li>● MDS 12.1 Q</li> <li>● MDS 17.1 Q</li> <li>● MDS 19.1 Q</li> </ul>
Weigh cells	<ul style="list-style-type: none"> <li>● AXIS-M 30.1 W</li> <li>● AXIS-M 40.1 W</li> <li>● AXIS-M 50.1 W</li> </ul>	
4 section steps (VariSpread4)	<ul style="list-style-type: none"> <li>● AXIS-M 30.1 W</li> <li>● AXIS-M 40.1 W</li> </ul>	
8 section steps (VariSpread8)	<ul style="list-style-type: none"> <li>● AXIS-M 50.1 W</li> </ul>	

### 2.2 Overview of compatible control units

Type	QUANTRON-A	QUANTRON-E	QUANTRON-E2
as of software version:	2.00.00	3.51.00	2.20.00

2.3 Layout of the control unit QUANTRON-Guide

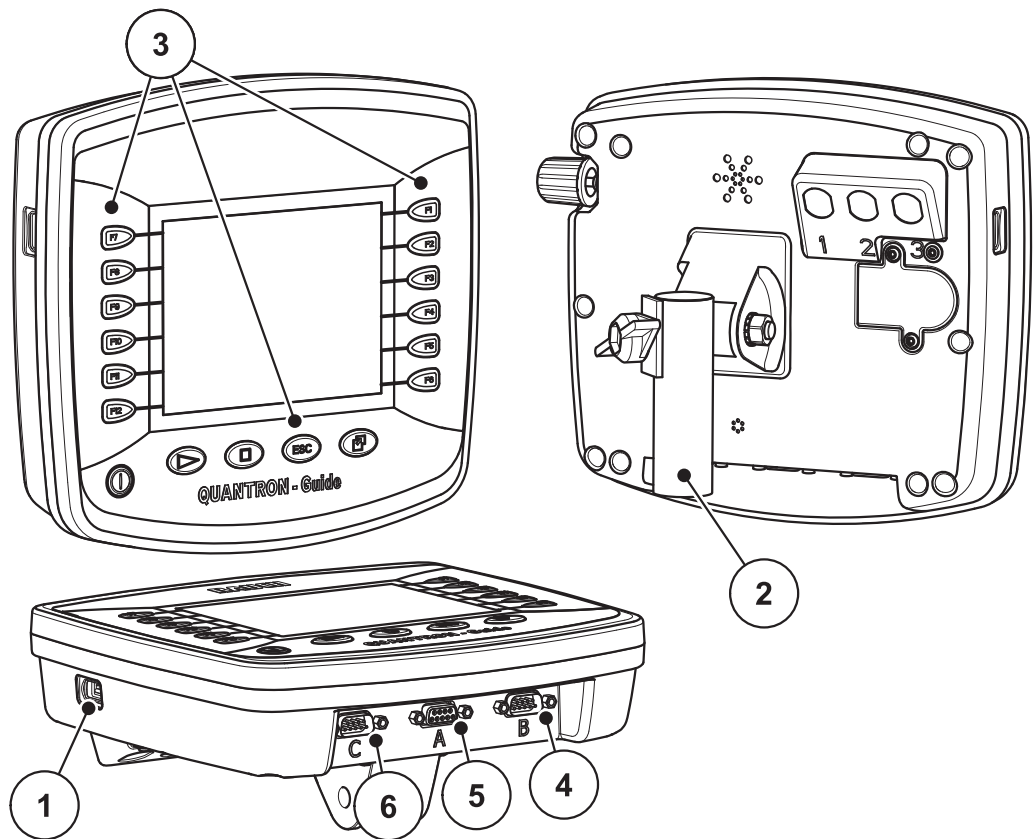
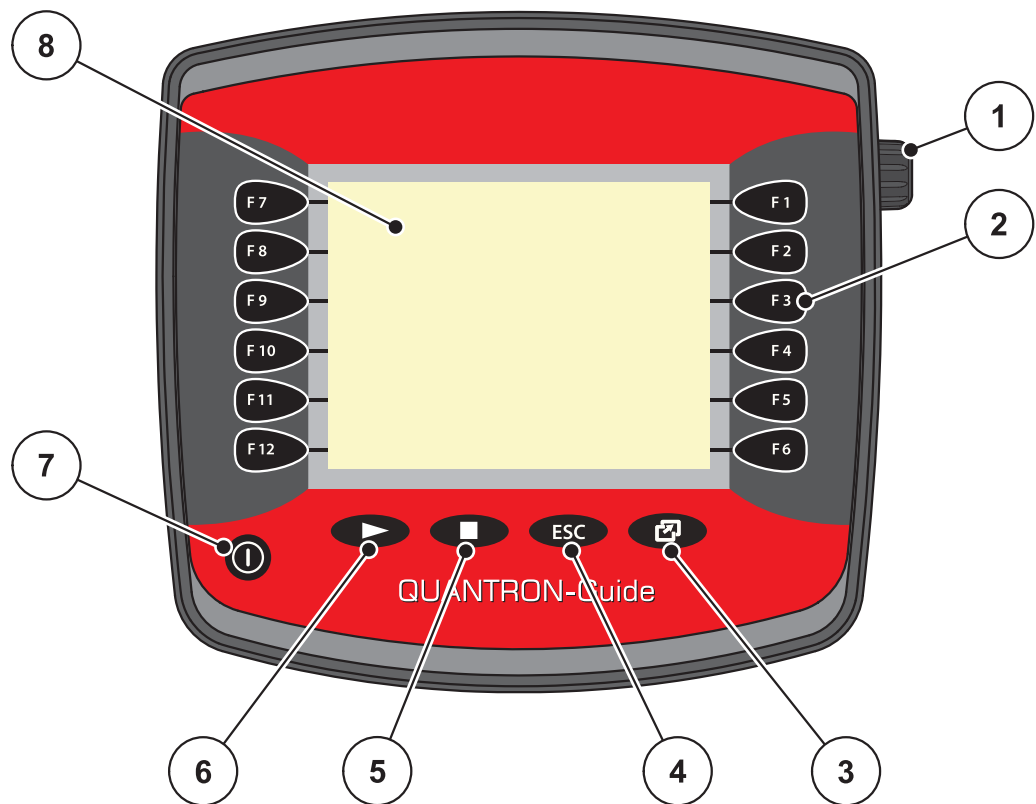

Figure 2.1: Control unit QUANTRON-Guide

No.	Designation	Function
1	USB port with cover	For exchanging data and updating the PC. The cover serves as protection against dirt.
2	Mounting bracket	Attaches the control unit to the tractor.
3	Control panel	Including membrane keys to operate the device and the display for operating screens.
4	V24 data port	Serial interface (RS232) with LH 5000 and WPS protocol, designed for Y-RS232 cables for connection to a remote terminal. Plug connector (DIN9684-1/ISO11786) for 7-pin to 8-pin cable connection for the speed sensor.
5	Power supply	3-pin plug connector conforming to DIN9680 / ISO12369 for power supply connection.
6	GPS receiver	9-pin plug connector for connecting the GPS receiver to the QUANTRON-Guide.

## 2.4 Control elements

### 2.4.1 Overview



**Figure 2.2:** Front of the QUANTRON-Guide control panel

No.	Designation	Function
1	Scroll wheel	For fast navigation in the menus and entering or changing data in input fields.
2	Function keys	Selection of the functions next to the function keys on the display.
3	Menu key	Display of the available menu: Service, Task Manager and TRACK-Leader
4	Operating key	No function
5	Operating key	No function
6	Operating key	No function
7	On/Off	Switches the device on/off
8	Display	Display of operating screens

### 2.4.2 Function keys

On the left and right-hand side, next to the screen of the QUANTRON-Guide control unit, 2 groups of 6 function keys each are allocated in a vertical position.

The assignment of the function keys depends on the displayed menu screens. Functions are generally executed by pressing the function key next to the symbol.

Function keys without a symbol do not have **any** functionality in the respective menu screens.

### 2.4.3 Scroll wheel

The scroll wheel is used for fast navigation in the menus as well as for entering or changing data in input fields.

- Turning the scroll wheel enables navigation between the selectable fields.
- Pressing the scroll wheel confirms the selection.

## 2.5 Display

The display shows the current status information as well as the selection and input options for the control unit QUANTRON-Guide.

The basic information on the operation of the mineral fertiliser spreader are displayed in the **operating screens** and the subordinate menu screens.

### Description of the operating screen

#### NOTICE

The exact representation of the operating screen depends on the actual settings selected.

- For additional information and display options, refer to the original operating manual of Müller Elektronik.
- The original operating manual is included in the scope of delivery. If it is missing, please contact your salesperson.

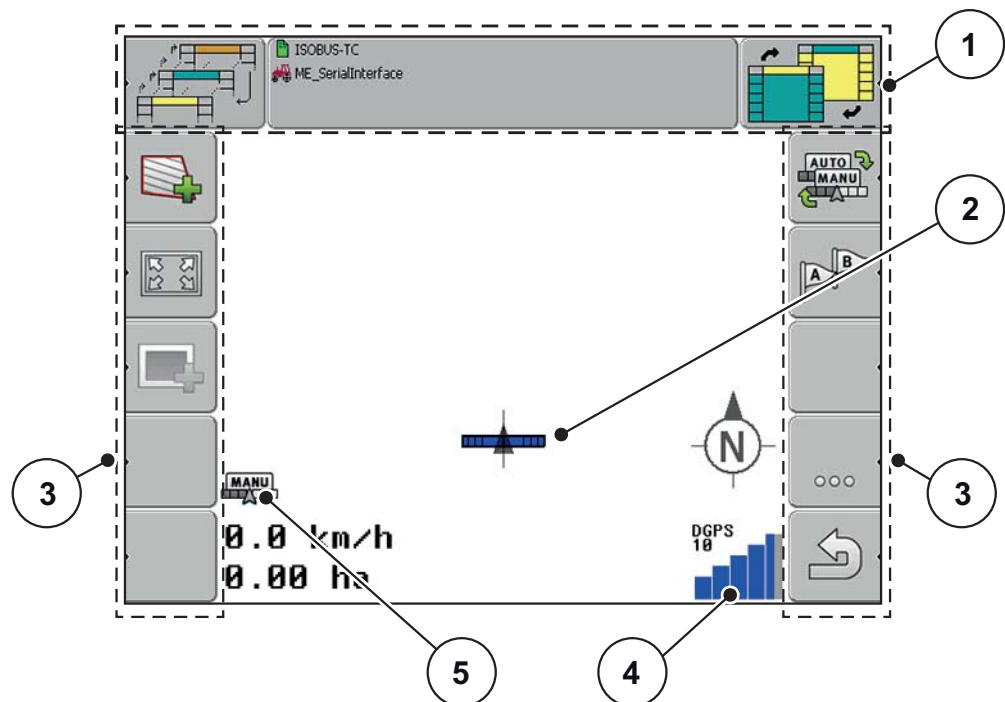













**Figure 2.3:** QUANTRON-Guide Page 1

- [1] Header
- [2] Tractor and machine position
- [3] Function keys
- [4] GPS signal status
- [5] Operating mode

2.6 Library of symbols used

The screen of the QUANTRON-Guide control unit displays symbols for menus and functions.

Symbol	Meaning
	Back to the previous screen
	Continue
	Save: Save field data on USB stick
	Load: Import field data from USB stick
	Calculate field border
	Automatic/Manual mode
	Display entire field
	3D view
	2D view
	Create guide track.
	Register obstacle
	Calibrate GPS signal

### 3 Attachment and installation

#### 3.1 Tractor requirements

Before installing the control unit, check to make sure your tractor meets the following requirements:

- A minimum voltage of **12 V** must **always** be guaranteed, even if multiple loads are connected simultaneously (e.g. air conditioning system, lights).
- The tractor must be equipped with a 3-pin power supply socket (DIN 9680/ISO 12369).

#### 3.2 Power supply

The control unit is supplied with power from the tractor via the 3-pin power supply socket (DIN 9680/ISO 12369).

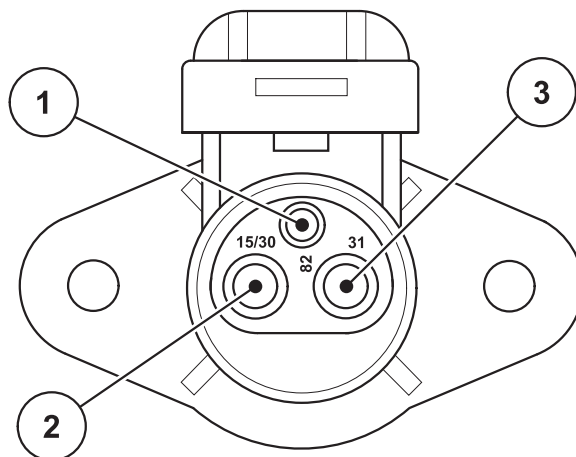

- [1] PIN 1: not required
- [2] PIN 2: (15/30): +12 V
- [3] PIN 3: (31): mass

**Figure 3.1:** PIN assignment of power socket

#### 3.3 QUANTRON-Guide connection

Connect the control unit QUANTRON-Guide to the fertiliser spreader. Refer to [“Schematic connection diagram” on page 13](#).

Proceed in the following order.

- Select a suitable position in the tractor cabin (within **the driver's field of vision**) to secure the QUANTRON-Guide control unit.
- Secure the QUANTRON-Guide by means of the **mounting bracket** in the tractor cabin.
- Connect the power supply from the tractor to **port A** of the control unit.
- Connect the null modem cable (RS232 interface) to **port B** of the control unit (QUANTRON-A/E/E2 and forward speed sensor).

#### NOTICE

To use the GPS Control functions of the QUANTRON-A/E/E2, the serial communication must be activated in the **System/test** menu, sub-menu **Data transmission**, sub-menu item **GPS Control**.

---

#### ⚠ CAUTION



#### Damage caused by short circuits

The GPS receiver can be damaged if it is connected to a running control unit.

- ▶ The GPS receiver may only be connected to **switched-off** control units.
- 

- Connect the GPS receiver to **port C** of the control unit.



Schematic connection diagram:

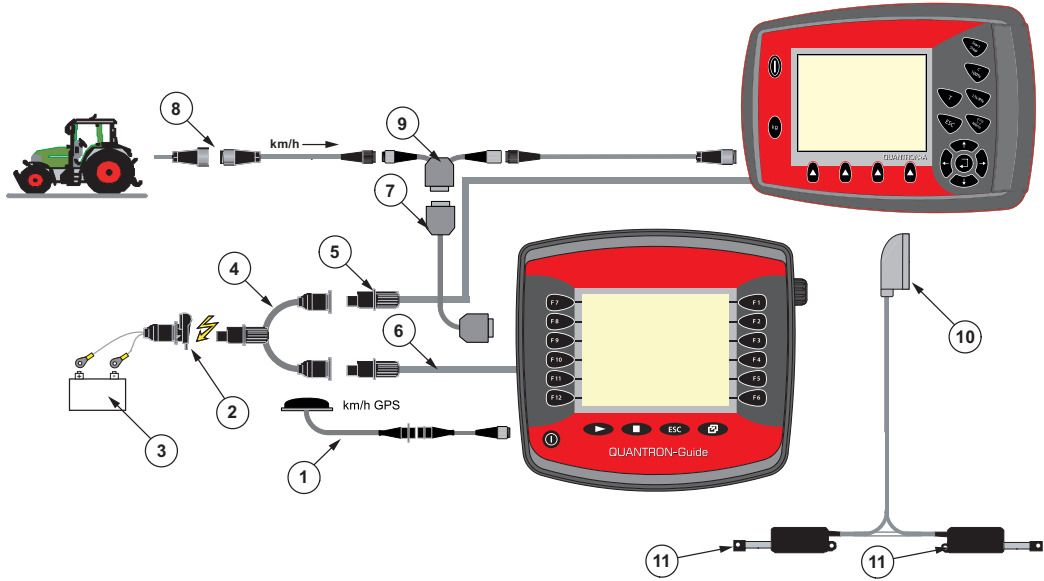

Figure 3.2: Schematic connection diagram

- [1] GPS cable and receiver
- [2] 3-pin plug connector conforming to DIN 9680 / ISO 12369
- [3] Battery
- [4] Y cable (3-pin plug connector conforming to DIN9680/ISO12369)
- [5] QUANTRON-A/E/E2 power supply
- [6] QUANTRON-Guide power supply
- [7] Null modem cable (V24 RS232 interface)
- [8] 7-pin plug connector conforming to DIN9684
- [9] Y cable (V24 RS232 interface)
- [10] 39-pin machine plug
- [11] Metering slide actuator left/right



## 4 Operation QUANTRON-Guide

### NOTICE

The operating manual describes the functions of the control unit for the following software versions:

- QUANTRON-Guide 04.10.04
- TRACK-Leader II 2.11.03

### 4.1 Control unit activation

#### Requirements:

- The control unit is connected properly to the mineral fertiliser spreader and to the tractor (for an example, see chapter [3.3: QUANTRON-Guide connection, page 12](#)).
- A minimum voltage of **12 V** is guaranteed.



#### 1. Press the **ON/OFF** switch.

- ▷ After a few seconds, the **start-up screen** with the application that was last used is displayed.

## 4.2 Machine settings

Before starting spreading, specify the mineral fertiliser spreader and the settings you are working with.

In the **Machine list** menu, set the data of an existing mineral fertiliser spreader or create a new machine.



1. Press the **Menu** key at the control unit.
  - ▷ Afterwards, the **Selection menu** is displayed.



Figure 4.1: Selection menu QUANTRON-Guide

2. Open the **Serial Interface** menu.

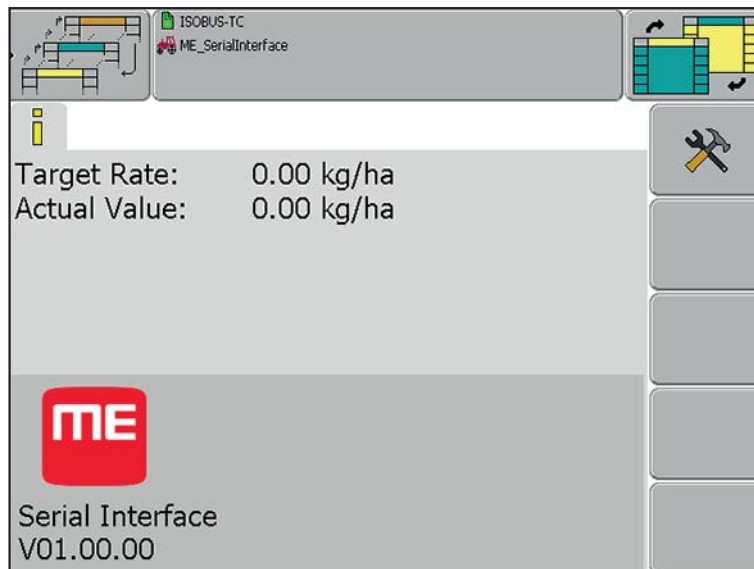
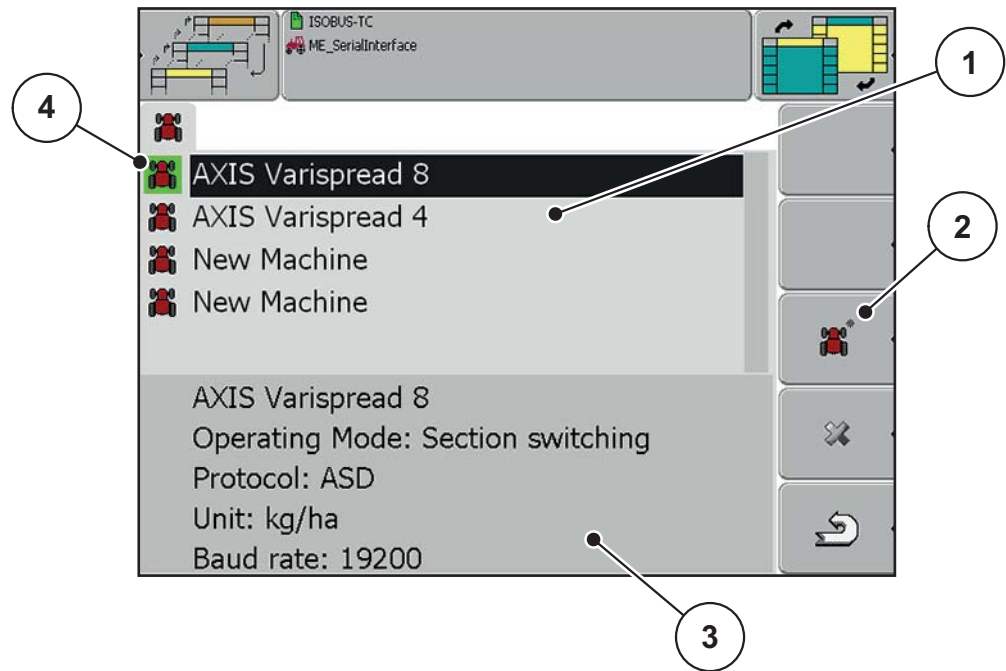

Figure 4.2: Serial Interface menu



3. Press the **Settings** function key.
  - ▷ A list of the saved machines is displayed.



**Figure 4.3:** Machine list menu

- [1] List of the saved mineral fertiliser spreaders
- [2] Create new machine function key
- [3] Settings of the highlighted machine
- [4] Active machine (profile with green background)

**NOTICE**

No data from the QUANTRON-A/E2 control unit will be applied in the QUANTRON-Guide control unit.

**4.2.1 Create new machine**



1. Press the **New machine** function key.
2. Enter a name for the new profile.
  - ▷ The new machine is listed.

4.2.2 Changing machine settings

1. Highlight the respective machine profile.
2. Press the scroll wheel.

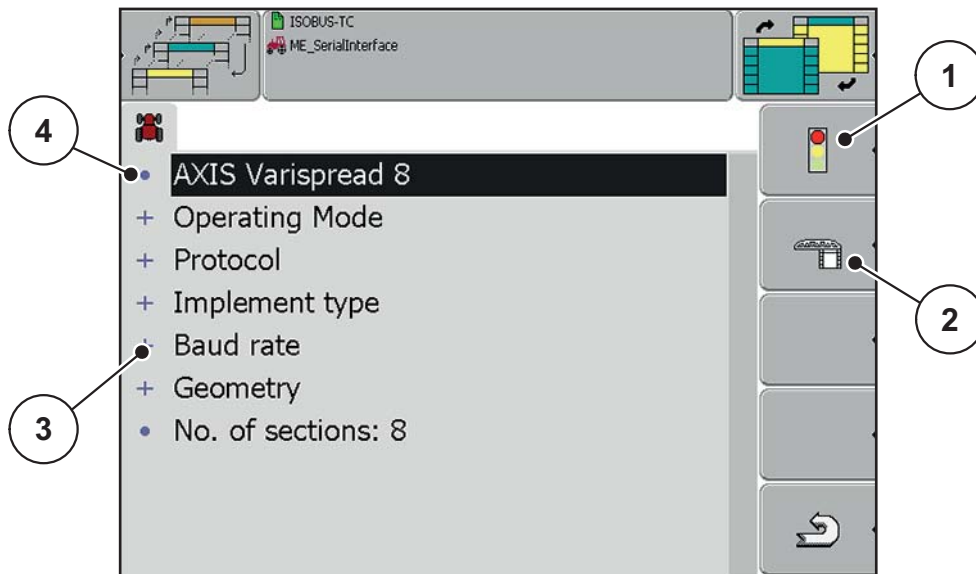

Figure 4.4: Machine profile

- [1] Machine profile activation
- [2] Section adjustment
- [3] Setting entries
- [4] Machine profile designation

3. Check the settings of the mineral fertiliser spreader and adjust if necessary. The bottom table lists the setting options for RAUCH products.

Menu	Description
Operating mode	Set value transmission <ul style="list-style-type: none"> <li>• Operation with application cards</li> </ul> Section control <ul style="list-style-type: none"> <li>• Operation with Section-Control</li> </ul>
Protocol	<ul style="list-style-type: none"> <li>• LH 5000 (serial communication e.g. spreading using application cards)</li> <li>• WSC (working with Section-Control)</li> </ul>
Implement type	<ul style="list-style-type: none"> <li>• Fertiliser spreader (kg)</li> </ul>
Baud rate	<ul style="list-style-type: none"> <li>• 19 200</li> </ul>
Geometry	<ul style="list-style-type: none"> <li>• Working width of the machine: enter the set working width of the fertiliser spreader.</li> <li>• Position of the GPS receiver, set to 0. Position is received from TECU.</li> </ul>
Number of sections	<ul style="list-style-type: none"> <li>• 8</li> <li>• 4</li> </ul>

4.2.3 Section adjustment (AXIS only)

1. Open the **Calculate VariSpread** menu at the QUANTRON-E2/A control unit.

Fertiliser settings <span style="float: right;">4/4</span>			
Calculate VariSpread			
Width (m)	drp.pt.	RPM	Applic. rate (%)
9.00	0.0	540	AUTO
7.50	0.0	540	AUTO
6.00	0.0	540	AUTO
4.50	0.0	540	AUTO
0.00	0.0	540	AUTO

**Figure 4.5:** Calculate VariSpread, example with 8 sections and a working width of 18 m

- [1] Adjustable section settings
- [2] Predefined section settings

2. Calculate the distance between the individual sections as follows.
  - Distance of sections 1 and 8 = half width - (minus) first section
  - Distance of sections 2 and 7 = first section - (minus) second section
  - Distance of sections 3 and 6 = second section - (minus) third section
  - Distance of sections 4 and 5 = third section - (minus) closed position (0)

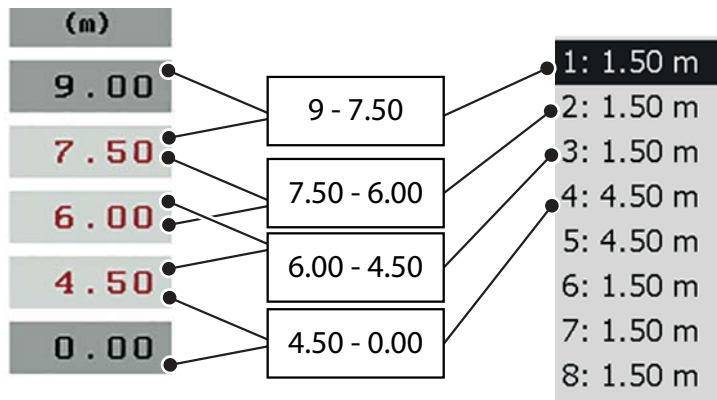

**Figure 4.6:** Conversion of sections to distances

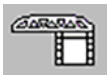

3. At the QUANTRON-Guide control unit, press the **Section** function key.
4. Enter the calculated distance values under point [2].

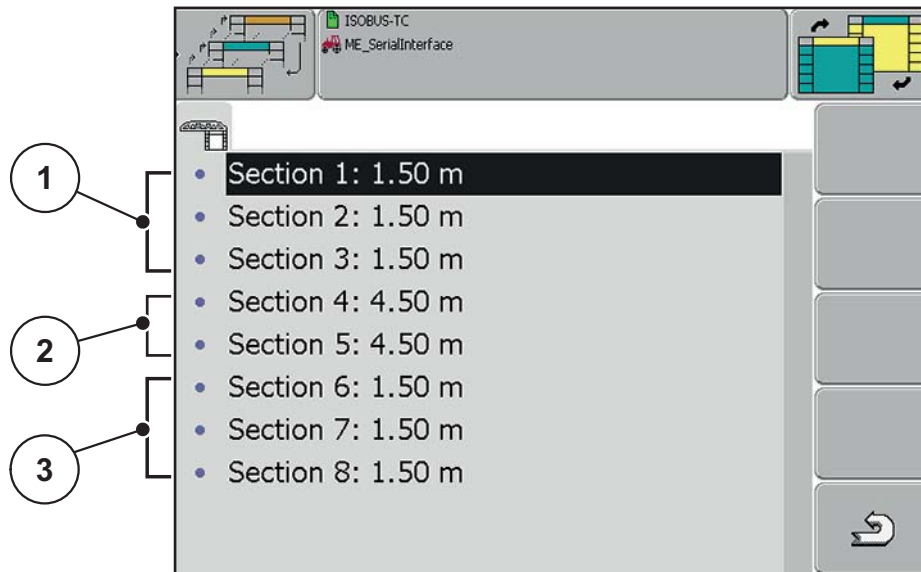

**Figure 4.7:** Section settings, example with 8 sections and a working width of 18 m

- [1] Distance between the outer sections, left
- [2] Width of the inner sections on the left/right spreading side
- [3] Distance between the outer sections, right

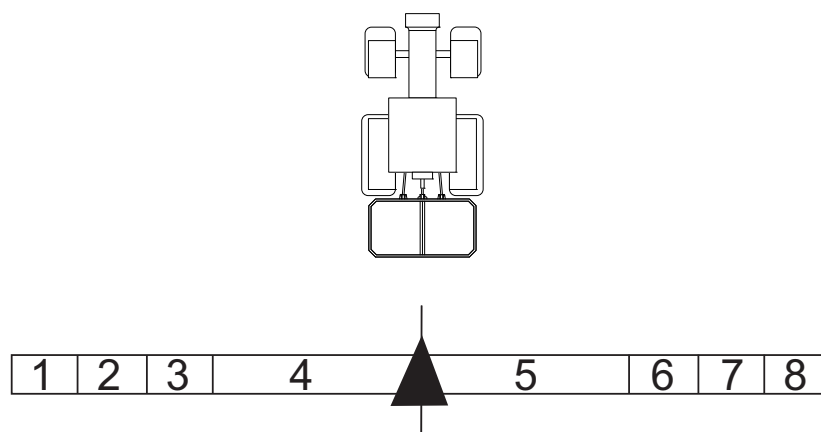
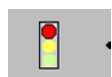

**Figure 4.8:** Representation of the sections at the screen



5. Press **Back**.
  - ▷ The machine profile is displayed.

#### 4.2.4 Machine profile activation



1. Press the **Traffic light** key in the machine profile.
  - ▷ The machine is activated.
2. Press **Back**.
  - ▷ The activated machine is highlighted in green. Refer to [figure 4.3](#), position [4].



### 4.3 Selection menu QUANTRON-Guide

1. Press the **Menu** key.
  - ▷ Afterwards, the **selection menu** is displayed.
2. Open the **TRACK-Leader** menu.

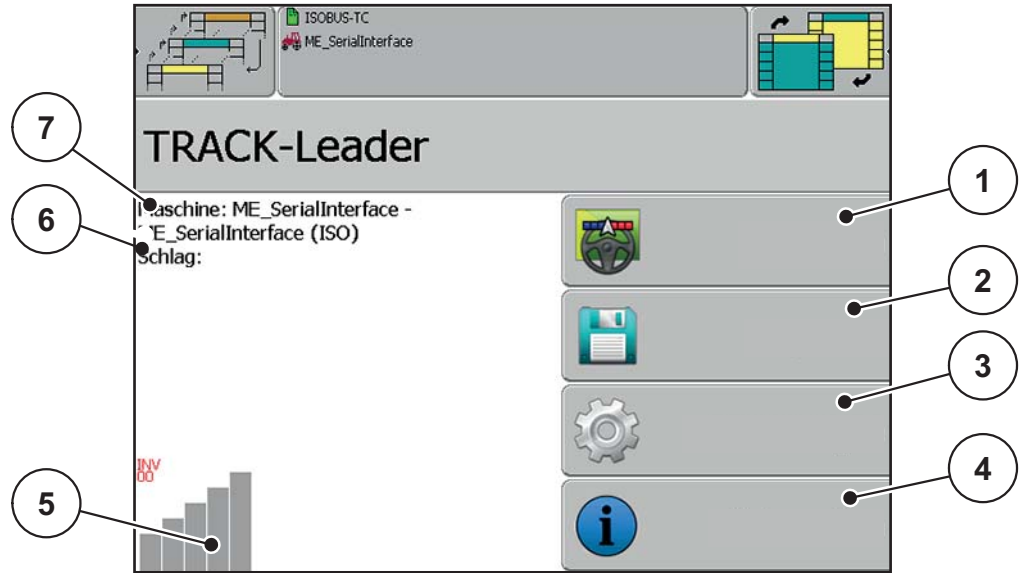

**Figure 4.9:** TRACK-Leader screen

**NOTICE**

The quality of the GPS signal may fluctuate greatly; check the quality of the GPS signal on the bar graph in the selection menu and/or on the operating screen. The more bars displayed in blue, the better the quality of the GPS signal.

No.	Symbol	Meaning	Description
1	Navigation	<ul style="list-style-type: none"> <li>• Field data management</li> <li>• Creation of a new field</li> </ul>	<a href="#">Page 25</a>
2	Storage	Import/export of field data or application sticks via USB stick	<a href="#">Page 30</a>
3	Settings	Management of applications (Section-Control) and settings of the QUANTRON-Guide control unit (display, navigation display)	<a href="#">Page 22</a>
4	Information		<a href="#">Page 31</a>
5	GPS	GPS signal status	
6	Field	Name of the current field	
7	Machine	Display of the active mineral fertiliser spreader	

### Section-Control activation

Before navigation, ensure that the Section-Control application is activated.



1. Open the **Settings > General** menu.

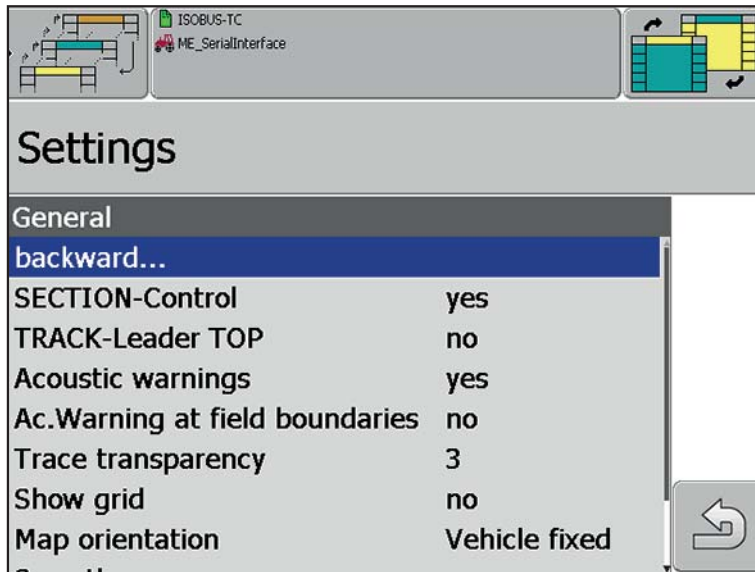

**Figure 4.10:** Section-Control activation

2. Highlight the **Section-Control** menu item.
  3. Select **yes**.
- ▷ **Section-Control is activated.**

#### 4.4 Transfer of OptiPoint settings (AXIS only)

The QUANTRON-E2/A control unit uses the **OptiPoint** function to calculate the optimum activation/deactivation intervals **in headlands**.

1. Open the **Fertiliser settings > Calculate OptiPoint** on the control unit.
  - ▷ The first page of the **Calculate OptiPoint** menu is displayed.

**NOTICE**

For the distance factor for the applied fertiliser, please refer to the fertiliser chart of the machine.

2. Enter the distance factor from the enclosed spreading table.
3. **Press Enter.**
  - ▷ The second page of the menu is displayed.

**NOTICE**

The indicated forward speed refers to the forward speed in the area of the switching positions!

4. **Enter the Average forward speed** in the range of switching positions.
5. Press **OK**.
6. Press **Enter.**
  - ▷ The third page of the menu is displayed.
7. If required, adjust the values.
 

To do so, refer to the operating manuals of the QUANTRON-E2 or QUANTRON-A control units.
8. Press **Enter.**
9. Highlight the **Accept values** menu item.
  - ▷ The menu **GPS Control Info** is displayed.

GPS Control Info	
Prerequisites for Section Control	
Distance (m)	-13.1
Delay on (s)	0.0
Delay off (s)	0.0
Länge (m)	2.4

**Figure 4.11:** GPS Control Info (example QUANTRON-E2)



1. Open the **Selection menu > Navigation** menu on the QUANTRON-Guide control unit.
2. Enter the **distance (m)** value under **Spreading distance**.
3. Enter the **Length (m)** value under **Working length**.

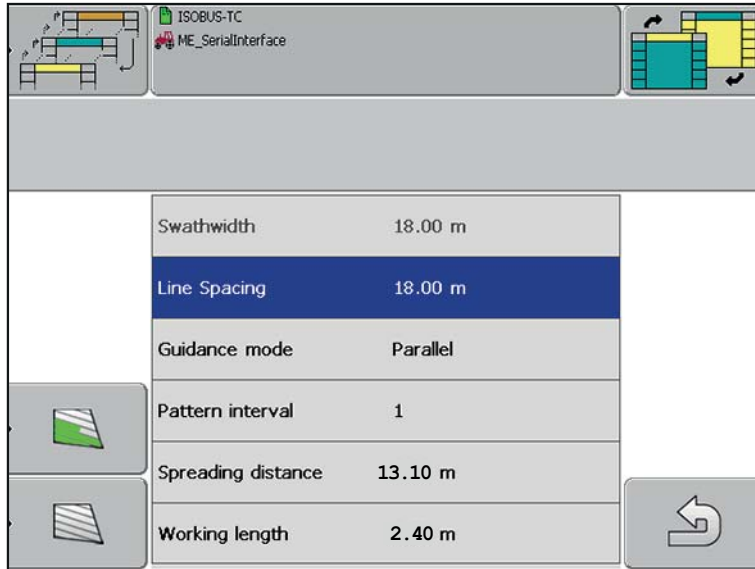

Figure 4.12: Navigation menu

**NOTICE**

For further instructions on settings, refer to the enclosed TRACK-Leader operating manual of Müller Elektronik.

## 4.5 Navigation

In the **Navigation** menu, the parameters for processing a new field or an already identified field are displayed.

### NOTICE

When starting a new navigation, any existing field data must first be deleted from the temporary memory of the control unit! See chapter [4.6.3: Deleting field data, page 31](#).

### 4.5.1 Create field



1. Open the **Selection menu > Navigation** menu.

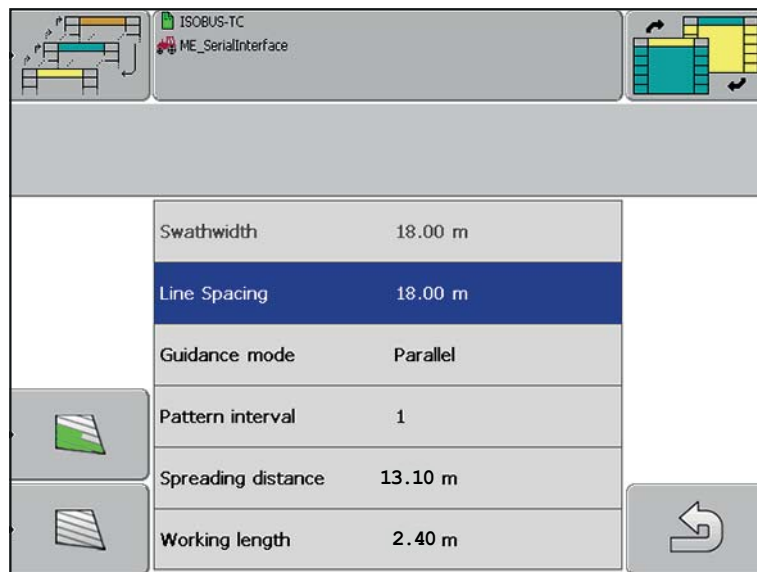

**Figure 4.13:** Navigation menu



2. Press the **New** function key.
  - ▷ The operating screen is displayed.

### NOTICE

The quality of the GPS signal may fluctuate greatly; check the quality of the GPS signal on the bar graph in the selection menu and/or on the operating screen. The more bars displayed in blue, the better the quality of the GPS signal.

### NOTICE

The field has to be circled in **MANU** mode!

3. Press **Start/Stop** at the control unit of your fertiliser spreader (QUANTRON-A/E/E2).

4. Circle the entire field with the mineral fertiliser spreader.
  - ▷ The field border is recorded by the QUANTRON-Guide control unit.
5. Circle the field until the starting point.

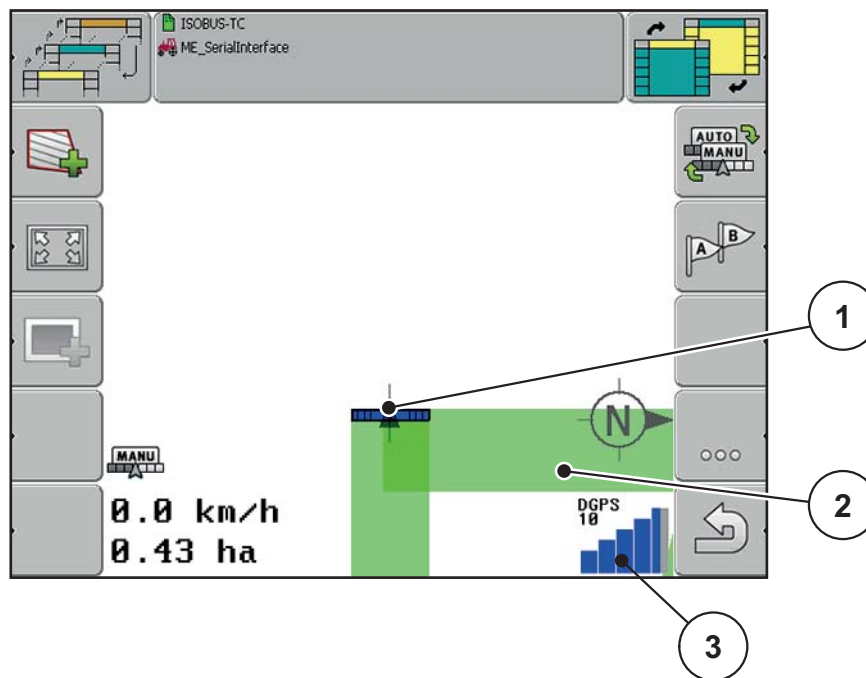

**Figure 4.14:** Field circling display

- [1] Mineral fertiliser spreader position
- [2] Field circling track
- [3] GPS signal strength

### NOTICE

Ensure that the track of circling around the field is closed on the display!



6. Press the **Calculate field border** function key at the QUANTRON-Guide control unit.
  - ▷ The field borders are displayed in red.

## 4.5.2 Spreading with GPS Control



1. Press the **AUTO/MANU** function key at the QUANTRON-Guide control unit.
  - ▷ The **AUTO** mode is activated.
2. Press the **Start/Stop** function key at the QUANTRON-A/E/E2 control unit.

### NOTICE

To use the GPS Control functions of the QUANTRON-A/E/E2 control unit, the serial communication must be activated in the **System/test** menu, sub-menu **Data transmission**, sub-menu item **GPS control**.

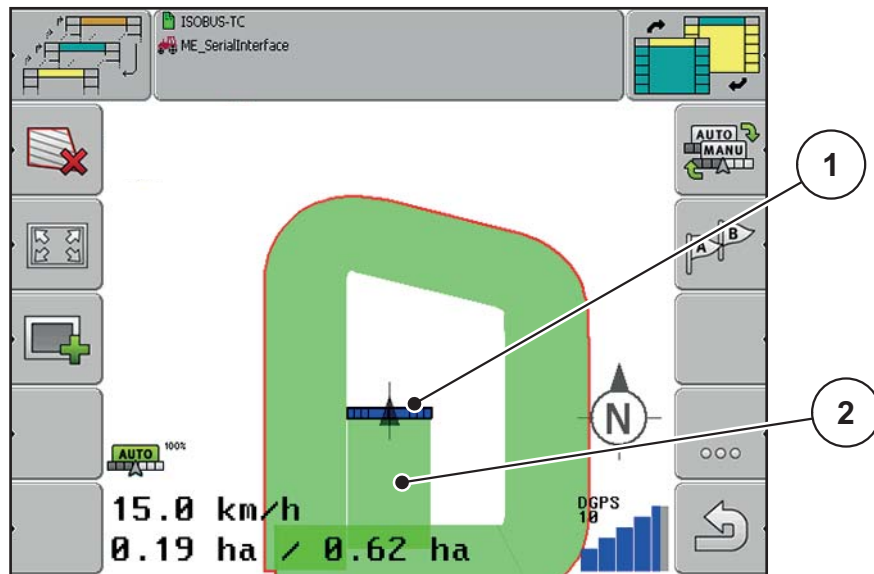

**Figure 4.15:** QUANTRON-Guide spreading work display

- [1] Machine bar
- [2] Area already spread

### NOTICE

The fertiliser distribution indicated on the display of the QUANTRON-Guide control unit does not necessarily correspond to the actual fertiliser distribution in the field!

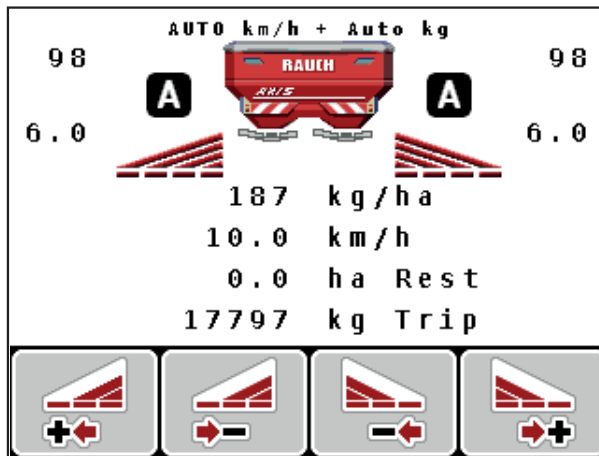

Figure 4.16: QUANTRON-A/E2 spreading work display

3. Start spreading.

- ▷ The metering slides open and close automatically.
- ▷ At the QUANTRON-Guide control unit, the status of the metering slides is displayed by machine bars in different colours.
  - Blue: Section activated, metering slides open
  - Red: Section deactivated, metering slides closed
- ▷ On the display of the QUANTRON-A/E2 control unit, the symbol **A** next to the spreading wedges indicates that the automatic function is enabled.

**NOTICE**

During spreading, in the area of the activation/deactivation position of the metering slides, the forward speed of the tractor must correspond to the underlying forward speed in order to achieve an optimal spreading result!



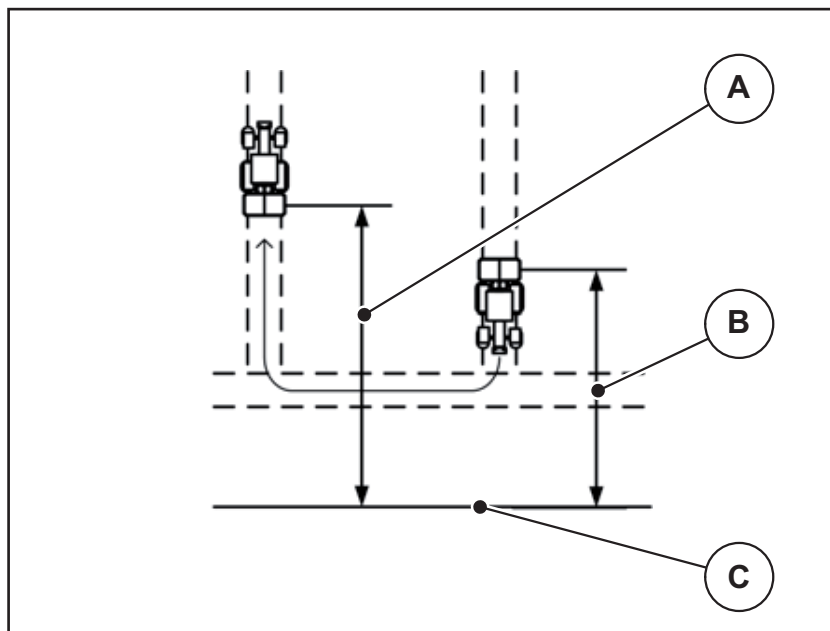

**Figure 4.17:** Activation and deactivation position

- [A] Activation distance
- [B] Deactivation distance
- [C] Field border

4. Press the **Start/Stop** function key at the QUANTRON-A/E/E2 control unit.
  - ▷ Spreading is finished.



5. At the QUANTRON-Guide control unit, press the **AUTO/MANU** function key.
  - ▷ On the display, the mode will switch from **AUTO** to **MANU**.

### 4.6 Storage

All field data of a field to be processed can be saved on a USB stick:

- Field borders
- Reference point
- Guide tracks
- Obstacles
- Drives

In the **Storage** menu, field data can be saved, loaded and deleted.

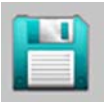

1. In the **Selection menu**, select **Storage**.

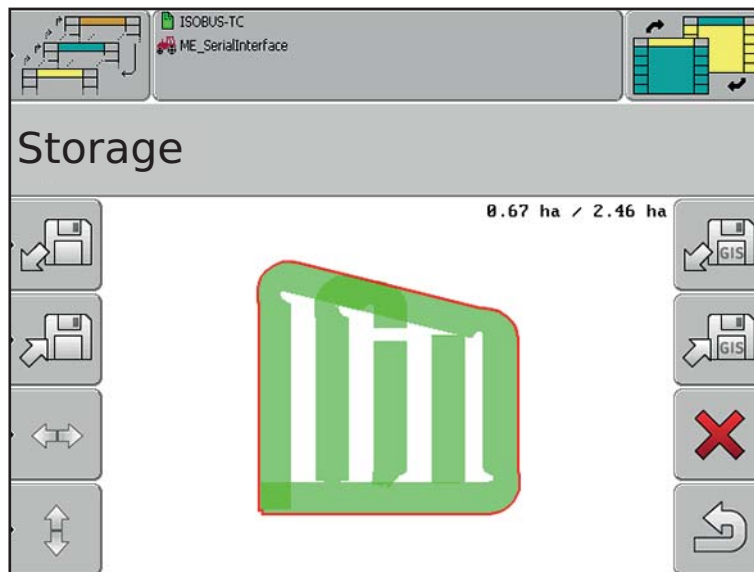

Figure 4.18: Storage menu

#### 4.6.1 Saving field data

##### NOTICE

A USB stick must be plugged into the USB port! See chapter [2.3: Layout of the control unit QUANTRON-Guide, page 6](#)



1. The **Save** function key.
  - ▷ A text input field is displayed.
2. Enter a name for the field file to be saved.

Text input: refer to the original operating manual of Müller Elektronik.

  - ▷ The data is saved to the USB stick.

## 4.6.2 Loading field data

### NOTICE

A USB stick must be plugged into the USB port! See chapter [2.3: Layout of the control unit QUANTRON-Guide, page 6](#)



1. In the **Storage** menu, press the **Load** function key.
  - ▷ A selection screen with all stored field data is displayed.
2. Select the desired field data.
  - ▷ The data is now uploaded from the USB stick.
  - ▷ The loaded field is displayed in the Storage menu.

## 4.6.3 Deleting field data

When deleting field data, all information is deleted from the temporary memory of the control unit.

### NOTICE

After spreading, field data needs to be deleted to be able to create a new field. Loss of data!  
Deleted field data cannot be recovered. Save all important data before deleting it!



1. In the **Storage** menu, press the **Delete** function key.
  - ▷ A confirmation prompt is displayed: Do you really want to delete the record?
2. Confirm with **Yes**.
  - ▷ The current field data is deleted.

## 4.7 Information

In the **Information** menu, value inputs, activations and deactivations are carried out. These are required to operate the mineral fertiliser spreader with the QUANTRON-Guide control unit.

### NOTICE

Refer to the original TRACK-Leader operating manual of Müller Elektronik.

## 4.8 Saving the position of the GPS receiver

### Determining the position on the tractor

After installation and connection of the GPS receiver, a precise position must be entered.

To do so, the distance of the GPS receiver from the longitudinal axis and the machine coupling point has to be measured.

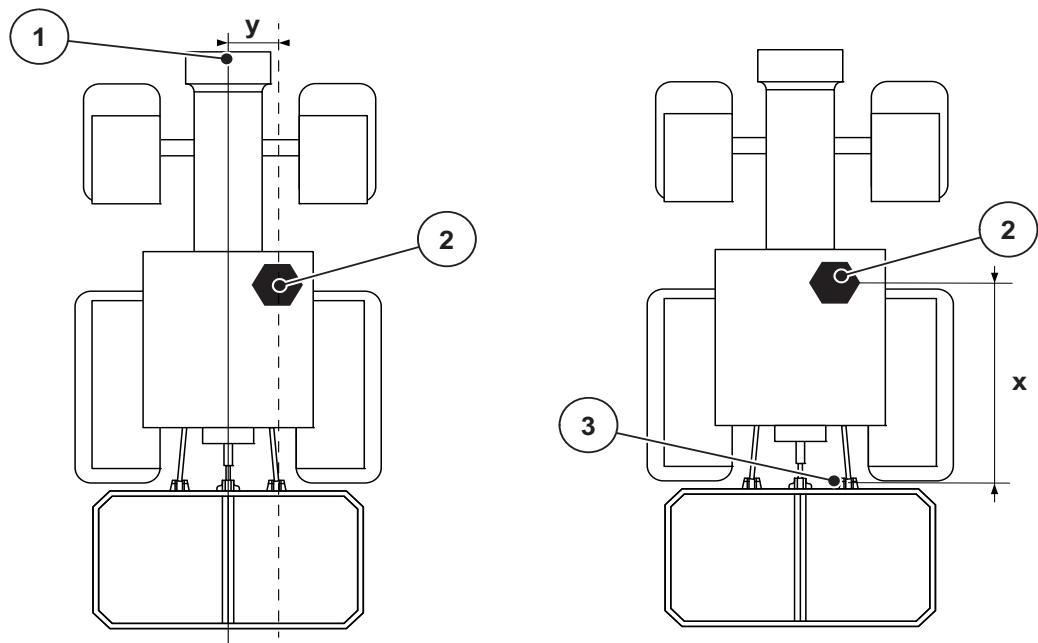

**Figure 4.19:** GPS receiver position

- [1] Longitudinal axis of the machine
- [2] GPS receiver
- [3] Spreader coupling point
- [x] Distance to the coupling point
- [y] Offset to the longitudinal axis

### Offset to the longitudinal axis (y distance)

- The GPS receiver is installed on the right side of the longitudinal axis
  - Enter a positive value
- The GPS receiver is installed on the left side of the longitudinal axis
  - Enter a negative value

### Distance to the coupling point

- The GPS receiver is installed in front of the coupling point in the direction of travel
  - Enter a positive value
- The GPS receiver is installed behind the coupling point in the direction of travel
  - Enter a negative value



### Control unit input

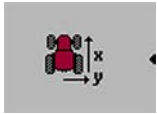

1. Press the menu key.
2. Open the tractor ECU.
3. Open the machine list and select the profile.

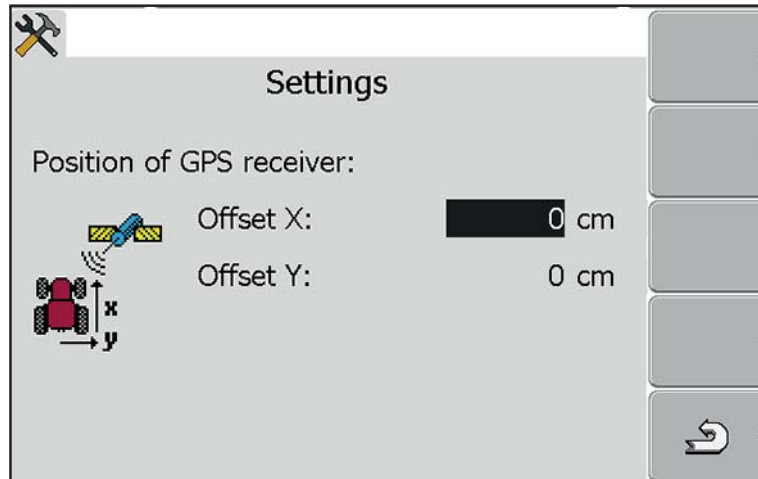

4. Enter the values.
- ▷ **The position of the GPS receiver is saved in the system.**



## 5 Alarm messages and possible causes

Various alarm messages can be displayed on the QUANTRON-Guide control unit.

### 5.1 Meaning of alarm messages

#### **NOTICE**

If any alarm messages are displayed at the control unit, please contact our dealer or service centre.

<b>Alarm messages on the display</b>	<b>Possible cause/action</b>
WPS-LostAlive	The connection to the QUANTRON-A/E/E2 was interrupted
GPS signal failed	The connection to the GPS receiver was interrupted No GPS reception

### 5.2 Fault/alarm

#### 5.2.1 Acknowledging alarm messages

Alarm messages are highlighted on the display and displayed with a warning symbol.

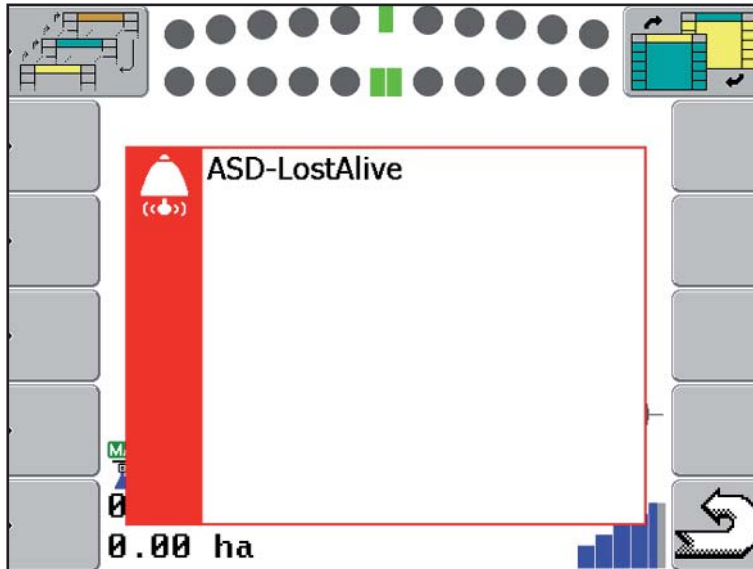

**Figure 5.1:** Alarm message

1. Correct the cause of the alarm message.

Observe the operating manual of the machine and section [5.1: Meaning of alarm messages, page 35](#).

2. Press **Back**.

▷ **The alarm message is cleared.**

#### **NOTICE**

If the fault cannot be corrected, have it corrected by a service specialist.

---



## Index

### A

Alarm messages 35

AXIS 5

### C

Control unit

activation 15

Attachment 11–13

Control elements 7

Display 9

Function keys 8

Layout 5

Mounting bracket 12

operation 15–33

Overview 5

Scroll wheel 8

### D

Display 9

Symbols 10

### F

Field

Calculation 26

Create 25

Field border 26

Navigation 24–25

Forward speed 23

Function key 8

AUTO/MANU 10

Menu key 16

Section 19

Settings 17

Traffic light 20

### G

GPS Control

Info 23

Switch off distance 29

Switch-on distance 29

### I

Information 31

### M

Machine

List 17

Profile 17, 20

Section adjustment 19

Settings 17–18

MDS 5

Menu

Navigation 3

Mode

AUTO 10, 27

MANU 10, 29

### O

OptiPoint 23

### S

Scroll wheel 8

Section 19–20

VariSpread 19

Section-Control 22

Selection menu 21

Serial Interface 16

Storage

Delete 31

Field data 30

Symbols

Library 10

### T

TRACK-Leader 21

### V

VariSpread 5, 19



## Terms/conditions of warranty

RAUCH units are manufactured with modern production methods and with the greatest care and are subject to numerous inspections.

Therefore RAUCH offers a 12-month warranty subject to the following conditions:

- The warranty begins on the date of purchase.
- The warranty covers material and manufacturing faults. Our liability for third-party products (hydraulic system, electronics) is limited to the warranty of the manufacturer of the equipment. During the warranty period, manufacturing and material faults are corrected free of charge by replacement or repair of the affected parts. Other rights extending beyond the above, such as claims for conversion, reduction or replacement for damages that did not occur in the object of supply are explicitly excluded. Warranty services are provided by authorised workshops, by RAUCH factory representatives or the factory.
- The following are excluded from coverage by the warranty: natural wear, dirt, corrosion and all faults caused by improper handling and external causes. The warranty is rendered void if the owner carries out repairs or modifications to the original state of the supplied product. Warranty claims are rendered void if RAUCH original spare parts were not used. Therefore, the directions in the operating manual must be observed. In all cases of doubt contact our sales representatives or the factory directly. Warranty claims must be submitted to the factory by 30 days at the latest after occurrence of the problem. The date of purchase and the serial number must be indicated. If repairs under the warranty are required, they must be carried out by the authorised workshop only after consultation with RAUCH or the company's appointed representatives. The warranty period is not extended by work carried out under warranty. Shipping faults are not factory faults and therefore are not part of the warranty obligation of the manufacturer.
- No claims for compensation for damages that are not part of RAUCH machines themselves will be accepted. This also means that no liability will be accepted for damage resulting from spreading errors. Unauthorised modifications of RAUCH machines may result in consequential damage, for which the manufacturer will not accept any liability. The manufacturer's liability exclusion will not apply in case of wilful intent or gross negligence by the owner or a senior employee, and in cases where – according to the product liability law – there is liability for personal injury or material damage to privately used objects in the event of defects in the supplied product. It will also not apply in the event that assured properties are absent, if the purpose of the assured properties was to protect the purchaser against damage that does not involve the supplied product itself.



**RAUCH**  
POWER FOR PRECISION

## **RAUCH Landmaschinenfabrik GmbH**



Landstraße 14 · D-76545 Sinzheim



Victoria-Boulevard E200 · D-77836 Rheinmünster

Phone +49 (0) 7221/985-0 · Fax +49 (0) 7221/985-200  
info@rauch.de · www.rauch.de · wap.rauch.de

