

## Complementary instructions



**Read carefully before using the machine!**

**Keep for future reference.**

This operator's manual/mounting manual is to be considered as part of the machine. Suppliers of new and second-hand machines are required to document in writing that the operator's manual/mounting manual was delivered with the machine and handed over to the customer..

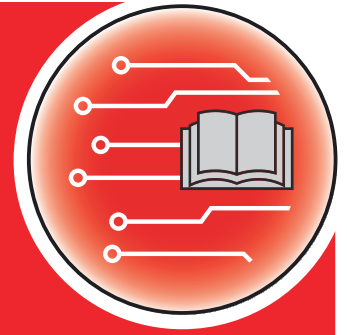

**AXIS EMC ISOBUS**

**Version 5.31.00**

5902180-|en-0124

Original instructions

Dear customer,

By purchasing the machine control unit AXIS EMC ISOBUS for the AXIS EMC mineral fertilizer spreader, you have shown confidence in our product. Thank you very much! We want to justify this confidence. You have purchased a powerful and reliable machine control unit.

However, in case unexpected problems arise, our customer service department is always there for you.



**Please read this operator's manual as well as the operator's manual for the machine carefully before using the machine, and follow the advice given.**

This manual may also describe equipment that is not included in your machine control unit.



**Note the serial number of the machine control unit and of the machine**

The machine control unit AXIS EMC ISOBUS has been calibrated at the factory for the fertilizer spreader with which it was supplied. It cannot be connected to another machine without new calibration.

Please enter the serial number of the machine control unit and of the machine here. When connecting the machine control unit to the machine, these numbers must be checked.

Serial number of electronic machine control unit:

Machine serial number:

Machine year of manufacture:

**Technical improvements**

We continuously strive to improve our products. For this reason, we reserve the right to make any improvements and changes to our machine that we consider necessary without notice. We do not accept any obligation to make such improvements or changes on machines that have already been sold.

We will be pleased to answer any other questions that you might have.

Yours sincerely

RAUCH Landmaschinenfabrik GmbH

# Table of contents

<b>1</b>	<b>User instructions</b>	<b>7</b>
1.1	About this operator's manual	7
1.2	Meaning of warnings	7
1.3	Notes on text descriptions	8
1.3.1	Instructions and procedures	8
1.3.2	Lists	8
1.3.3	References	8
1.3.4	Menu hierarchy, keys and navigation	9
<b>2</b>	<b>Layout and function</b>	<b>10</b>
2.1	Overview of supported machines	10
2.2	Display	10
2.2.1	Description of the working screen	10
2.2.2	Display fields	12
2.2.3	Display of the metering slide status	14
2.2.4	Display of sections	15
2.3	Library of icons used	15
2.3.1	Navigation	15
2.3.2	Menus	16
2.3.3	Working screen icons	17
2.3.4	Other icons	19
2.4	Structural menu overview	20
<b>3</b>	<b>Attachment and installation</b>	<b>23</b>
3.1	Tractor requirements	23
3.2	Connections, sockets	23
3.2.1	Power supply	23
3.2.2	Connecting the machine control unit	23
3.2.3	Metering slide preparation	27
<b>4</b>	<b>Operation</b>	<b>28</b>
4.1	Switching on the machine control unit	28
4.2	Navigation within the menus	29
4.3	Main menu	30
4.4	Fertilizer settings	31

4.4.1	Application rate .....	34
4.4.2	Setting the working width .....	34
4.4.3	Flow factor .....	35
4.4.4	Drop point .....	36
4.4.5	Calibration test .....	36
4.4.6	Disc type .....	39
4.4.7	Rotation speed .....	39
4.4.8	Boundary spreading mode .....	41
4.4.9	Boundary spreading quantity .....	41
4.4.10	Calculate OptiPoint .....	42
4.4.11	GPS Control info .....	43
4.4.12	Fertilizer charts .....	44
4.5	Machine settings .....	48
4.5.1	AUTO/MAN mode .....	50
4.5.2	+/- quantity .....	51
4.6	Fast emptying .....	52
4.7	System/Test .....	54
4.7.1	Total data counter .....	55
4.7.2	Test/diagnosis .....	56
4.7.3	Service .....	59
4.8	Info .....	59
4.9	Weighing/Trip counter .....	59
4.9.1	Trip counter .....	60
4.9.2	Rest (kg, ha, m) .....	61
4.9.3	Zero scales .....	62
4.10	Operating lights (SpreadLight) .....	63
4.11	Hopper cover .....	64
4.12	Special functions .....	66
4.12.1	Changing the system of units .....	66
4.12.2	Using the joystick .....	67
4.12.3	WIFI module .....	70
<b>5</b>	<b>Spreading operation .....</b>	<b>72</b>
5.1	Requesting the remaining quantity during spreading .....	72
5.2	Refilling .....	72
5.3	TELIMAT boundary spreading unit .....	73
5.4	Electrical TELIMAT unit .....	74
5.5	Working with sections .....	75
5.5.1	Displaying the spreading type in the operating screen .....	75
5.5.2	Spreading with reduced sections: VariSpread V8 .....	76
5.5.3	Spreading with reduced sections: VariSpread pro .....	78
5.5.4	Spreading operation with one section and in boundary spreading mode .....	80
5.6	Spreading with the automatic operating mode (AUTO km/h + AUTO kg) .....	81
5.7	Idle measurement .....	82
5.7.1	Automatic idle measurement .....	82
5.7.2	Manual idle measurement .....	84
5.8	Spreading with the AUTO km/h operating mode .....	84

---

5.9	Spreading with the MAN km/h operating mode.....	85
5.10	Spreading in the MAN scale operating mode.....	86
5.11	GPS control .....	88
<b>6</b>	<b>Alarm messages and possible causes.....</b>	<b>92</b>
6.1	Meaning of the alarm messages .....	92
6.2	Fault/alarm.....	96
6.2.1	Acknowledging an alarm message .....	97
<b>7</b>	<b>Special equipment.....</b>	<b>98</b>
<b>8</b>	<b>Guarantee and warranty.....</b>	<b>99</b>



# 1 User instructions

## 1.1 About this operator's manual

This operator's manual is an **integral part** of the machine control unit.

The operator's manual contains important instructions for **safe, proper**, and economic **use** and **maintenance** of the machine control unit. Compliance with its stipulations helps to **avoid risks**, reduce repair costs and downtime, and to increase the reliability and service life of the machine controlled with it.

The operator's manual must be kept in an easily accessible location close to where the control unit is used (e.g., in the tractor).

The operator's manual does not replace your **own responsibility** as operator and operational staff of the machine control unit.

## 1.2 Meaning of warnings

The warnings in the operator's manual are classified according to the severity of the risk and the probability of its occurrence.

The warning symbols draw attention to the residual risks to which users of the machine are exposed. The warnings used are structured as follows:

---

Symbol + **signal word**

Explanation

---

### Level of danger of warnings

The level of danger is indicated in the signal word. The levels of danger are classified as follows:

#### **DANGER!**

##### **Type and source of danger**

This warning warns of a danger posing an immediate threat to the health and life of people.

Ignoring these warnings will result in severe injury or death.

- ▶ Always observe the measures described to prevent this danger.

#### **WARNING!**

##### **Type and source of danger**

This warning warns of a potentially dangerous situation for personal health.

Ignoring these warnings leads to severe injury.

- ▶ Always observe the measures described to prevent this danger.

**⚠ CAUTION!**

**Type and source of danger**

This warning warns of a potentially dangerous situation for personal health.

Ignoring these warnings leads to injury.

- ▶ Always observe the measures described to prevent this danger.

**NOTICE!**

**Type and source of danger**

This warning warns of material and environmental damage.

Ignoring these warnings will result in damage to the machine and to the environment.

- ▶ Always observe the measures described to prevent this danger.



This is an instruction:

General instructions contain tips for the operation and information that is particularly useful, but no warnings about hazards.

## 1.3 Notes on text descriptions

### 1.3.1 Instructions and procedures

Steps that must be performed by operating staff are displayed as follows

- ▶ Instructions step 1
- ▶ Instructions step 2

### 1.3.2 Lists

Lists without a specific sequence are shown as lists with bullet points:

- Property A
- Property B

### 1.3.3 References

References to other sections in the document are shown with paragraph number, header text and/or page number:

- **Example:** Please also note 2 *Layout and function*



References to other documents are shown as information or instructions without the exact chapter or page number:

- **Example:** Follow the instructions in the operator's manual of the universal drive shaft manufacturer.

### 1.3.4 Menu hierarchy, keys and navigation

**Menus** are the entries listed in the **main menu** window.

The menus list **submenus and/or menu items** where settings can be made (selection lists, text or number entries, starting a function).

The various menus and buttons of the machine control unit are illustrated **in bold letters**.

The hierarchy and the path to the requested menu item are marked with an > (arrow) between menu and/or menu item(s):

- System / Test > System / Test > Test/diagnosis means that you can reach the menu item Voltage via the menu item System / Test and the menu item Test/diagnosis.
  - The arrow > corresponds to the operation of the **scroll wheel** and/or the button at the screen (touchscreen).

## 2 Layout and function



Due to the great variety of different ISOBUS-compatible terminals, this chapter is limited to the functions of the electronic machine control system without indicating a specific ISOBUS terminal.

- Please observe the instructions for the operation of your ISOBUS terminal in the corresponding operator's manual.

### 2.1 Overview of supported machines



Some models are not available in all countries.

- AXIS H 30.2 EMC, AXIS H 30.2 EMC + W
- AXIS H 50.2 EMC + W
- AXIS M 20.2 EMC, AXIS M 20.2 EMC + W
- AXIS M 30.2 EMC, AXIS M 30.2 EMC + W
- AXIS-M 50.2 EMC + W

#### Supported functions

- Spreading depending on forward speed
- Electrical drop point setting
- RPM control
  - AXIS-M 20.2/30.2/50.2 EMC (+W): Drive shaft speed
  - AXIS-H 30.2/50.2 EMC (+W): Spreading disc speed
- EMC - mass flow control
- Continuous section control

### 2.2 Display

The display shows the current status information as well as the selection and input options for the electronic machine control unit.

The most important information concerning the operation of the machine is displayed in the **working screen**.

#### 2.2.1 Description of the working screen



The exact representation of the working screen depends on the actual settings selected and on the machine type.

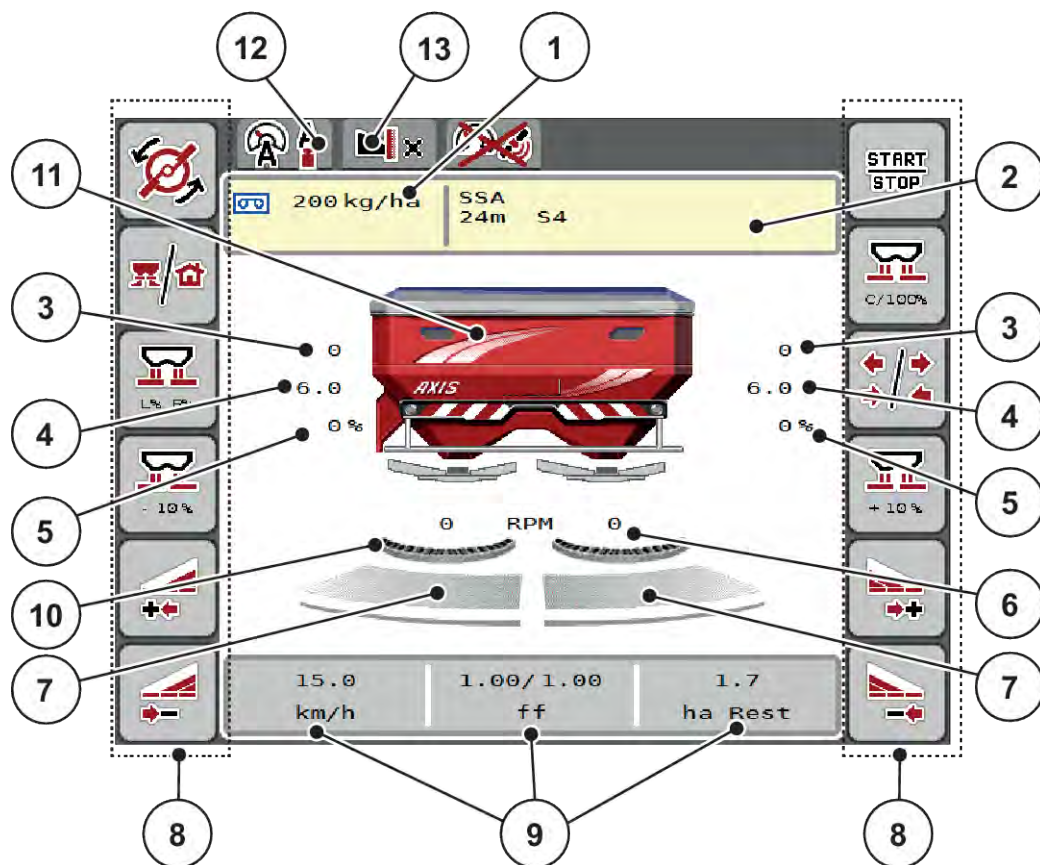

Fig. 1: Machine control unit display

- |  |   |
|--|---|
| [1] Current application rate from the fertilizer settings or the task controller<br>Button: direct entry of the application rate                 | [5] Quantity change, right/left               |
| [2] Fertilizer information display (fertilizer name, working width and spreading disc type) button<br>Button: Adjustment in the fertilizer chart | [6] Spreading disc speed, right/left          |
| [3] Metering slide position, right/left  | [7] Metering slide opening status, right/left |
| [4] Drop point position, right/left  | [8] Function keys                             |
|  | [9] Freely definable display fields           |
|  | [10] AXMAT- Function is active                |
|  | [11] Mineral fertilizer spreader display      |
|  | [12] Selected operating mode                  |
|  | [13] Display of boundary/border settings      |

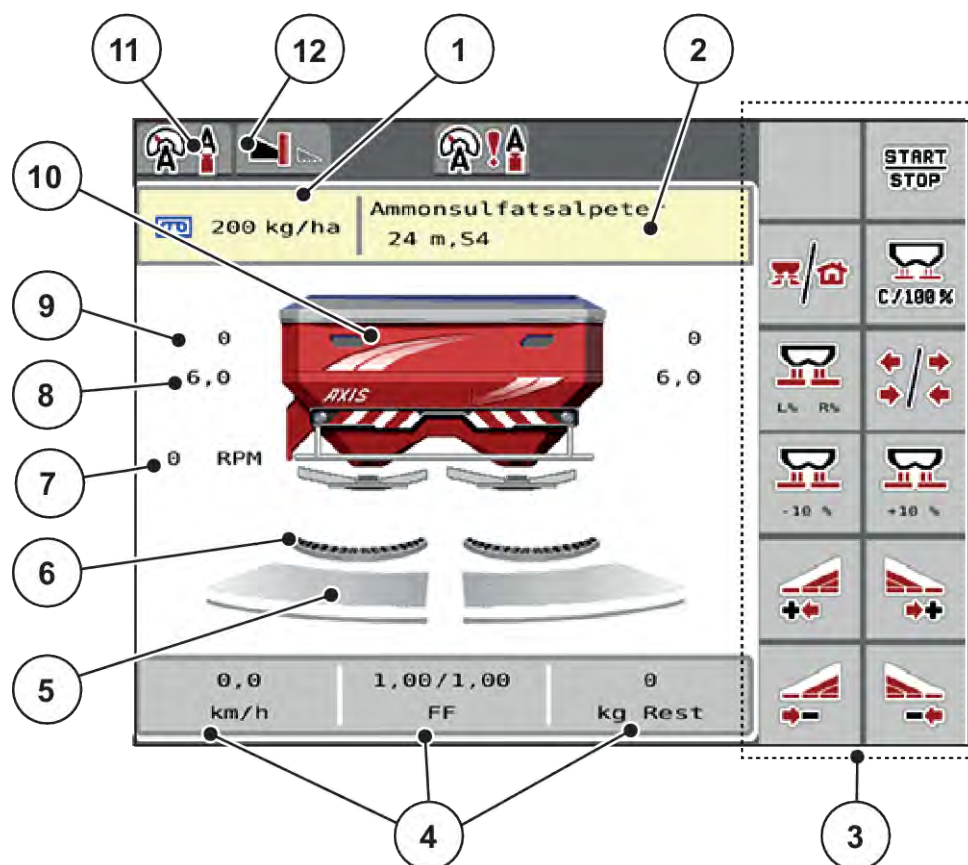

Fig. 2: Machine control unit display

- |   |   |
|---|---|
| [1] Current application rate from the fertilizer settings or the task controller<br>Button: direct entry of the application rate          | [5] Metering slide opening status, right/left |
| [2] Fertilizer information display (fertilizer name, working width and spreading disc type)<br>Button: Adjustment in the fertilizer chart | [6] AXMAT- Function is active                 |
| [3] Function keys   | [7] PTO speed                                 |
| [4] Freely definable display fields   | [8] Drop point position, right/left           |
|   | [9] Metering slide position, right/left       |
|   | [10] Mineral fertilizer spreader display      |
|   | [11] Selected operating mode                  |
|   | [12] Display of boundary/border settings      |

### 2.2.2 Display fields

The three display fields in the operating screen can be individually adjusted and assigned the following values as desired:

- Forward speed
- Flow factor (FF)
- ha trip
- kg trip
- m trip
- kg left
- m left
- ha left
- Idle time (Time until the next idle measurement)
- Torque (Spreading disc drive)

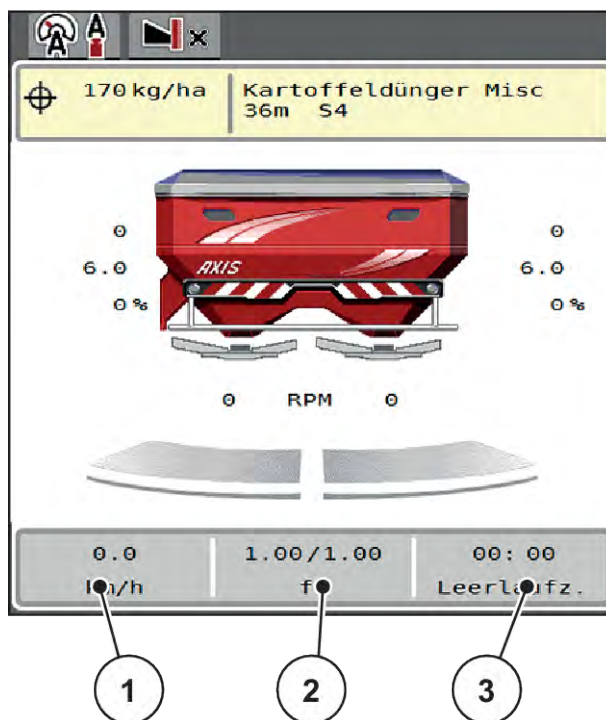

Fig. 3: Display fields

- [1] Display field 1  
[2] Display field 2

- [3] Display field 3

### Select display

- ▶ Press the corresponding display field in the touch screen.  
*The available options are displayed in a list.*
- ▶ Select the new value to be assigned to the display field.
- ▶ Press the OK button.  
*The operating screen is displayed.*

*The respective display field displays the new value.*

### 2.2.3 Display of the metering slide status

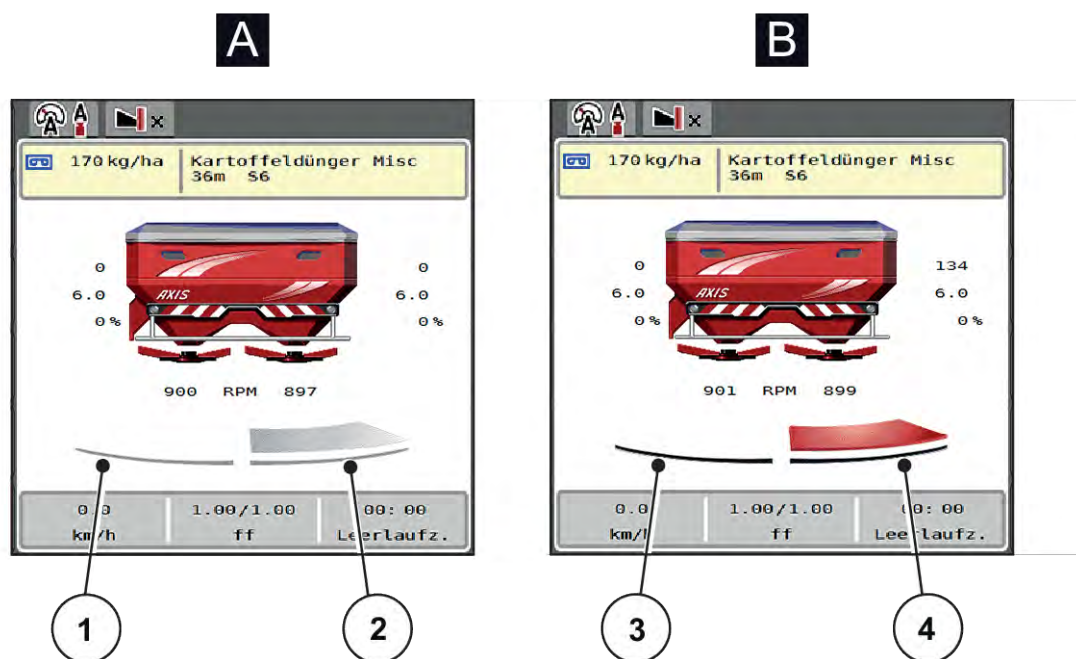

Fig. 4: Display of the metering slide status

[A] Spreading operation inactive

[1] Section deactivated

[2] Section activated

[B] Machine in spreading operation

[3] Section deactivated

[4] Section activated



In boundary spreading mode, you can **immediately deactivate an entire spreading side**. This is particularly helpful for a quick spreading operation in field corners.

- ▶ Press the softkey section reduction longer than 500 ms.

## 2.2.4 Display of sections

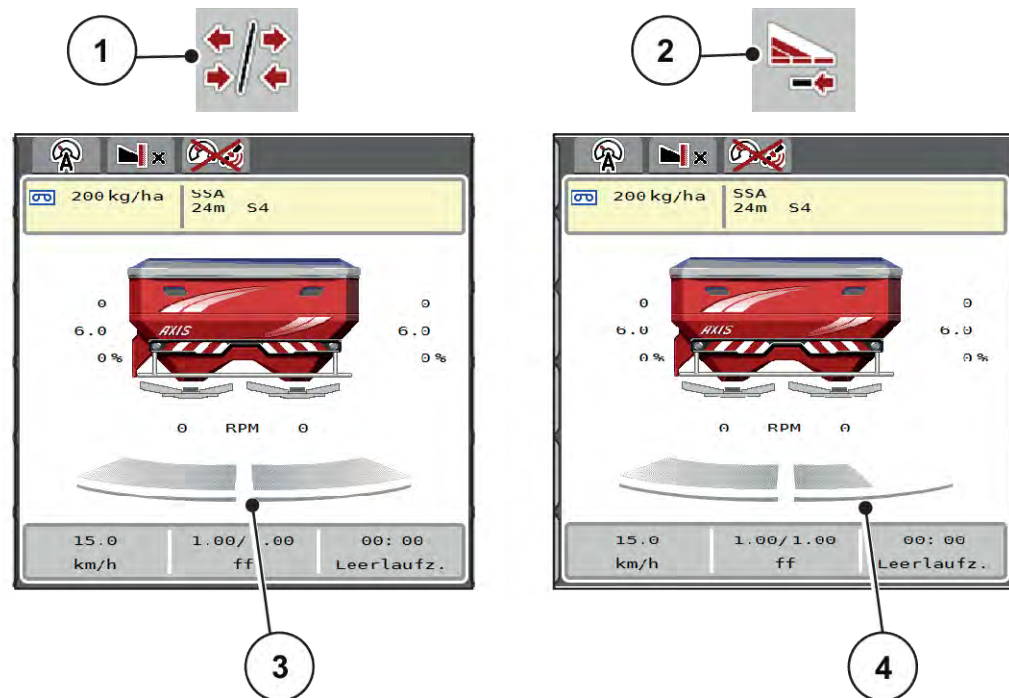

Fig. 5: Display of the section statuses

- [1] Section/boundary spreading toggle key
- [2] Reduce right section button
- [3] Activated sections on entire working width



- [4] Right section is reduced by several partial sections





Further display and setting options are explained in chapter 5.5 *Working with sections*.

## 2.3 Library of icons used











The AXIS EMC ISOBUS machine control unit displays icons for the individual menus and functions on the screen.

### 2.3.1 Navigation

Icon	Meaning
	Go to the left; previous page
	Go to the right; next page
	Back to the previous menu













Icon	Meaning
	Back to main menu
	Switch between working screen and menu window
	Acknowledgment of warning messages
	Cancellation, closing the dialog window













### 2.3.2 Menus









Icon	Meaning
	Switch from a menu window directly to the main menu
	Switch between working screen and menu window
	SpreadLight operating lights
	Hopper cover
	Fertilizer settings
	Machine settings
	Fast emptying
	System/Test
	Information
	Weighing/Trip counter







### 2.3.3 Working screen icons









Icon	Meaning
	Start spreading and control of application rate
	The spreading operation has started; stop the application rate regulation
	Start spreading discs
	Rotate the spreading discs; stop the spreading discs
	Reset the quantity adjustment to the pre-set application rate
	Switch between working screen and menu window
	Switch between boundary spreading and sections on the left, right or both spreading sides
	Sections on the left side, boundary spreading on the right spreading side
	Sections on the right side, boundary spreading on the left spreading side
	Boundary spreading on the left, right or both spreading sides
	Selection of the surplus/shortage quantity on the left, right or both spreading sides (%)
	Quantity adjustment + (plus)

Icon	Meaning
	Quantity adjustment - (minus)
	Quantity adjustment, left + (plus)
	Quantity adjustment, left - (minus)
	Quantity adjustment, right + (plus)
	Quantity adjustment, right - (minus)
	Manual quantity adjustment + (plus)
	Manual quantity adjustment - (minus)
	Increasing the spreading disc speed (plus)
	Reducing the spreading disc speed (minus)
	Left spreading side inactive
	Left spreading side active
	Right spreading side inactive
	Right spreading side active

Icon	Meaning
	Reduce left section (minus) <b>In boundary spreading mode:</b> Pressing and holding (> 500 ms) immediately deactivates an entire spreading side.
	Increase left section (plus)
	Reduce section, right (minus) <b>In boundary spreading mode:</b> Pressing and holding (> 500 ms) immediately deactivates an entire spreading side.
	Increase right section (plus)
	Activate right boundary spreading function/TELIMAT
	Right boundary spreading function/TELIMAT active
	Activate left boundary spreading function
	Left boundary spreading function active

### 2.3.4 Other icons

Icon	Meaning
	Start idle measurement, in the main menu
	Limited border spreading mode, in the working screen
	Full border spreading mode, in the working screen
	Limited border spreading mode, in the main menu

Icon	Meaning
	Full border spreading mode, in the main menu
	Operating mode AUTO km/h + AUTO kg
	Working mode AUTO km/h
	Operating mode MAN km/h
	Operating mode MAN scale
	EMC control deactivated
	Loss of the GPS signal (GPS J1939)
	The minimum mass flow is undercut
	The maximum mass flow is exceeded.

## 2.4 Structural menu overview

- *AXIS-M EMC*

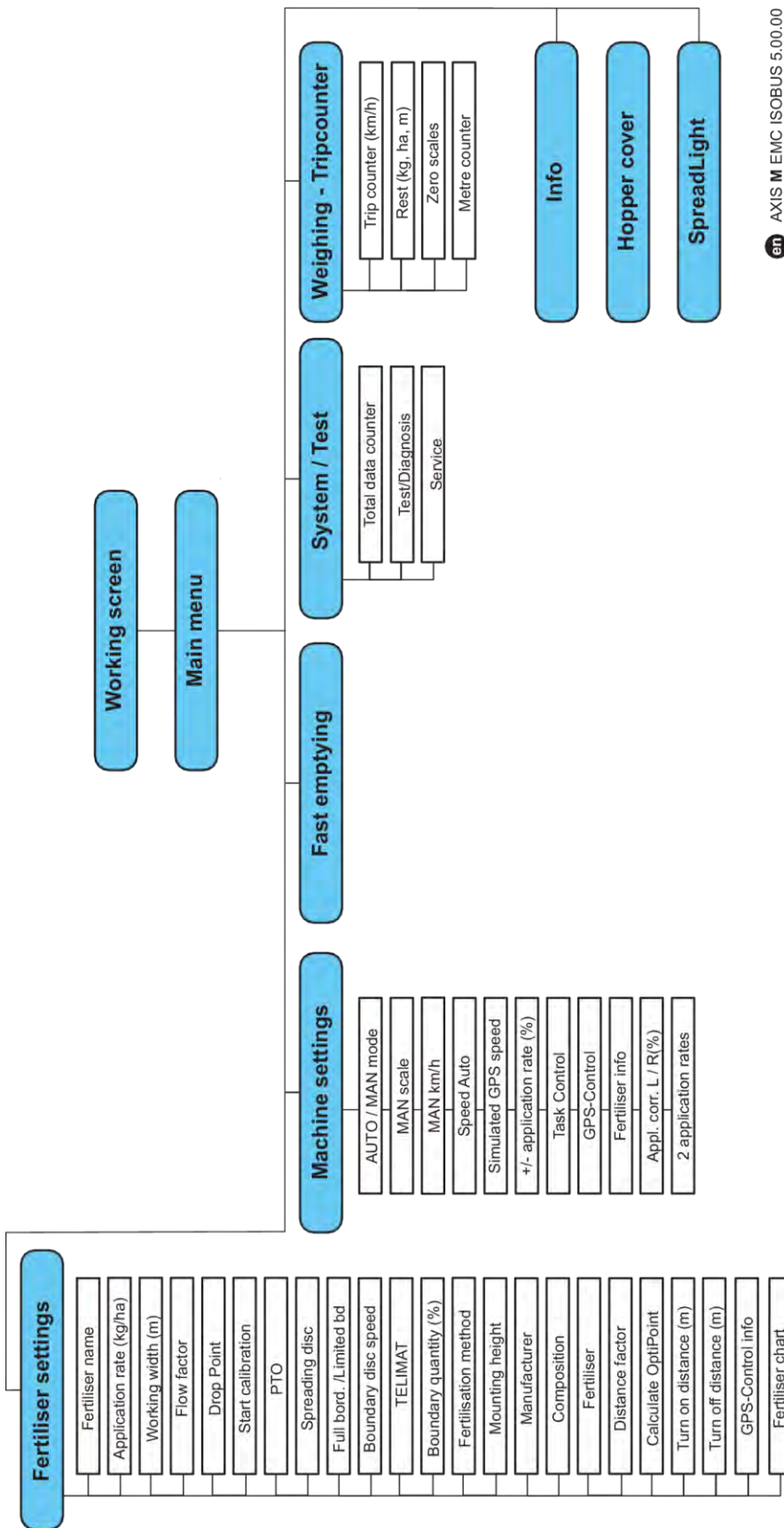

en AXIS M EMC ISOBUS 5.00.00

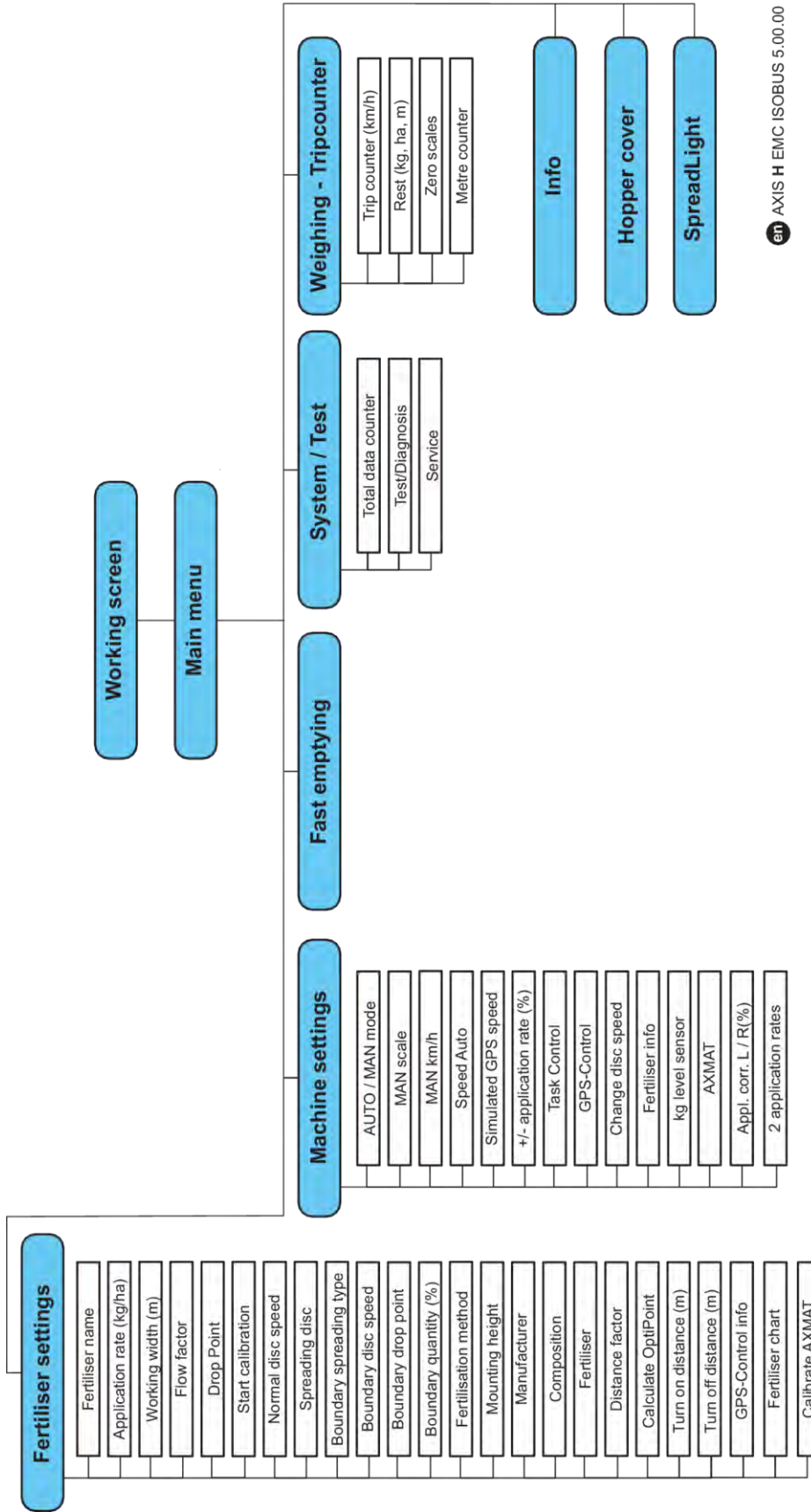

**en** AXIS H EMC ISOBUS 5.00.00

## 3 Attachment and installation

### 3.1 Tractor requirements

Before installing the machine control unit, ensure that your tractor meets the following requirements:

- A minimum voltage of **11 V** must **always** be guaranteed, even if multiple loads are connected simultaneously (e.g. air conditioning system, lights)
- Oil supply: **max. 210 bar**, single or double-acting valve (depending on equipment)
- AXIS-M: The PTO speed must have the following values and must be complied with (basic requirement for a correct working width).
  - AXIS-M 20.2, AXIS-M 30.2/40.2: minimum **540 rpm**
  - AXIS-M 50.2: minimum **750 rpm**



On tractors without load-switchable transmission, the forward speed must be selected by using the correct gear ratio in such a way that it corresponds to a PTO speed of **540 rpm** (AXIS-M 20.2, AXIS M 30.2) or **750 rpm** (AXIS M 50.2).

- **AXIS-H 30 EMC**: Hydraulics performance of **45 l/min**, constant current or load sensing system
- **AXIS-H 50 EMC**: Hydraulics performance of **65 l/min**, constant current or load sensing system
- Free return min. **NW 18 mm**
- 9-pin socket (ISO 11783) located at the rear of the tractor, for connecting the machine control unit to ISOBUS
- 9-pin terminal plug (ISO 11783) for connecting an ISOBUS terminal to the ISOBUS



If the tractor is not equipped with a 9-pin socket at the rear, a tractor assembly set including a 9-pin socket for the tractor (ISO 11783) and a forward speed sensor may be purchased additionally as special equipment.

### 3.2 Connections, sockets

#### 3.2.1 Power supply

The power supply of the machine control unit is implemented via the 9-pin socket at the rear of the tractor.

#### 3.2.2 Connecting the machine control unit

Depending on the equipment, there are different methods for connecting the machine control unit to the mineral fertilizer spreader. Further information can be obtained from the operator's manual of your machine.

■ Schematic connection diagram

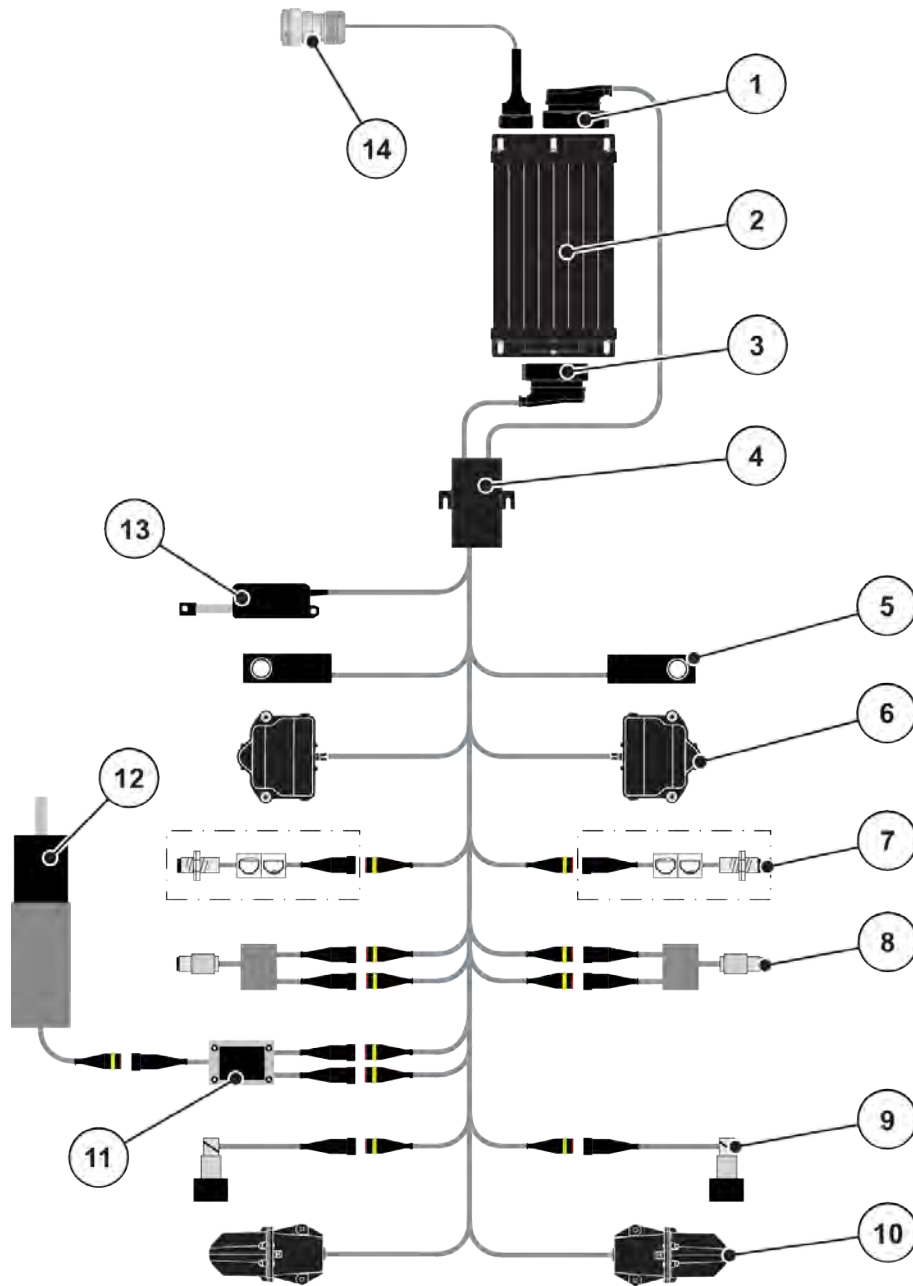

Fig. 6: AXIS-H EMC: Schematic connection diagram

- |   |                                       |
|---|---------------------------------------|
| [1] Machine plug                            | [8] Torque/speed sensor, left/right   |
| [2] Machine control unit                    | [9] Proportional valve, left/right    |
| [3] Machine plug                            | [10] Drop point motor, left/right     |
| [4] Cable distributor                       | [11] Agitator over-voltage protection |
| [5] Weigh cell left/right                   | [12] Electric agitator motor          |
| [6] Metering slide rotary drive, left/right | [13] Hopper cover actuator            |
| [7] Level sensor, left/right                | [14] ISOBUS connector plug            |



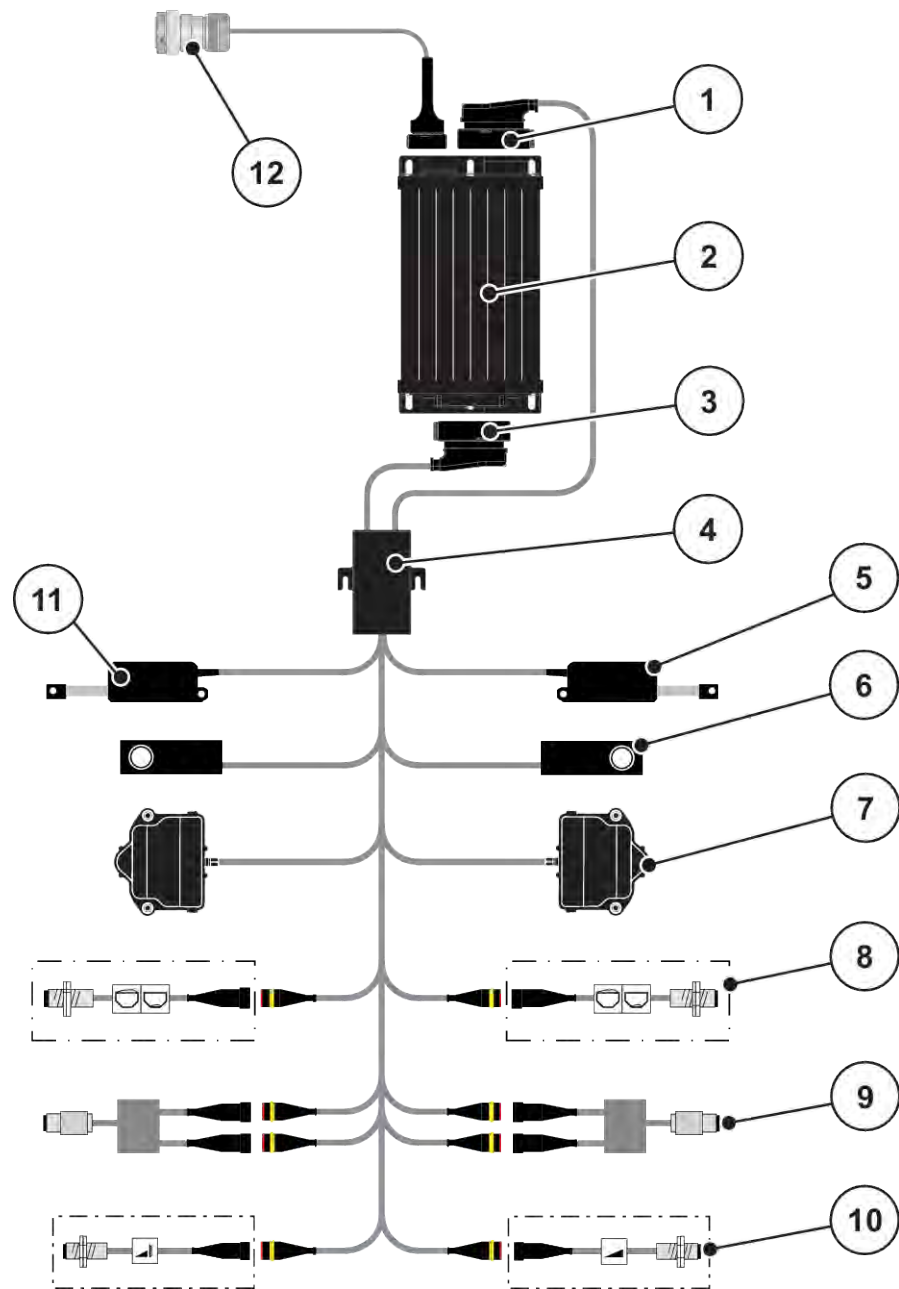

Fig. 7: AXIS-M 20.2 EMC: Schematic connection diagram

- |                           |   |
|---------------------------|---|
| [1] Machine plug          | [7] Metering slide rotary drive, left/right |
| [2] Machine control unit  | [8] Level sensor, left/right                |
| [3] Machine plug          | [9] Torque/speed sensor, left/right         |
| [4] Cable distributor     | [10] TELIMAT sensors, top/bottom            |
| [5] TELIMAT actuator      | [11] Hopper cover actuator                  |
| [6] Weigh cell left/right | [12] ISOBUS connector plug                  |

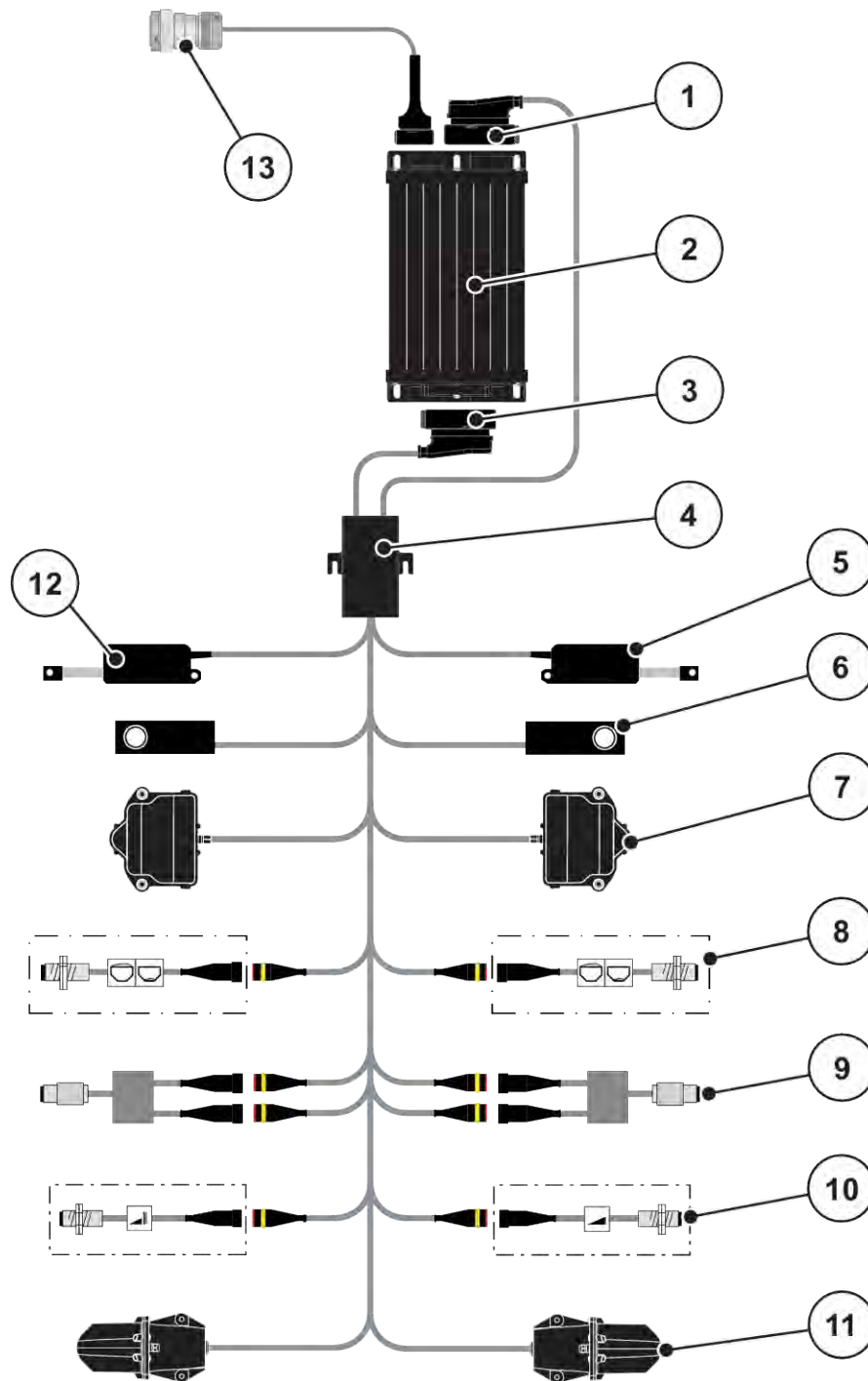

Fig. 8: AXIS-M 30.2 EMC, AXIS-M 50.2: Schematic connection diagram

- |   |                                     |
|---|-------------------------------------|
| [1] Machine plug                            | [8] Level sensor, left/right        |
| [2] Machine control unit                    | [9] Torque/speed sensor, left/right |
| [3] Machine plug                            | [10] TELIMAT sensors, top/bottom    |
| [4] Cable distributor                       | [11] Drop point motor, left/right   |
| [5] TELIMAT actuator                        | [12] Hopper cover actuator          |
| [6] Weigh cell left/right                   | [13] ISOBUS connector plug          |
| [7] Metering slide rotary drive, left/right |                                     |

### 3.2.3 Metering slide preparation

The machine control has an electronic slide actuator to set the application rate.



Please observe the operator's manual for your machine.

## 4 Operation

### ⚠ CAUTION!

#### Risk of injury due to ejected fertilizer

In the case of a fault, it is possible that the metering slide unexpectedly opens during road transport to the spreading location. There is a risk of slipping and personal injury due to ejected fertilizer.

- ▶ **Before leaving for the spreading location**, always switch off the electronic machine control unit.



The settings of each menu are very important for optimal **mass flow control (EMC function)**.

Please be particularly aware of the specifics of the EMC function for the following menu items:

- In the Fertiliser settings > Spreading disc menu, see page 39
- In the menu Fertiliser settings > Disc speed or the Fertiliser settings > Normal disc speed menu, see page 39
- In the menu Machine settings > AUTO/MAN mode, see chapter 4.5.1

### 4.1 Switching on the machine control unit

#### Requirements:

- The machine control unit is correctly connected to the machine and the tractor.
  - For an example, see Chapter 3.2.2 *Connecting the machine control unit*.
- The minimum voltage of **11 V** is guaranteed.

- ▶ Start the machine control unit.

*After a few seconds, the **start-up screen** of the machine control unit is displayed.*

*Subsequently, the machine control unit displays the **activation menu** for a few seconds.*

- ▶ Press the enter key.

*The working screen then appears.*



## 4.2 Navigation within the menus



Please refer to chapter 1.3.4 *Menu hierarchy, keys and navigation* for important notes regarding the display and navigation between menus.

Accessing menus and menu entries **by touching the touch screen or pressing the function keys** by touching the touch screen or pressing the function keys is described below.

- Observe the operator's manual of the terminal used.

### ■ *Accessing the main menu*

- ▶ Press the **Working screen/main menu** function key. See 2.3.2 *Menus*.



*The main menu is displayed.*

### Accessing the sub-menu via the touch screen

- ▶ Press the button of the desired sub-menu.

Windows appear with prompts for various actions.

- Text input
- Value input
- Settings made in further sub-menus



Not all parameters are displayed simultaneously on one screen. You can switch to the next or previous menu windows (tabs) using the **left/right arrow** keys.

### ■ *Exiting menus*

- ▶ Confirm settings by pressing the **Return** key.



*You will return to the previous menu.*

- ▶ Press the **Working screen/main menu** key.



*You will return to the working screen.*

- ▶ Press **ESC**.



*The previous settings are retained.*

*You will return to the previous menu.*

### 4.3 Main menu

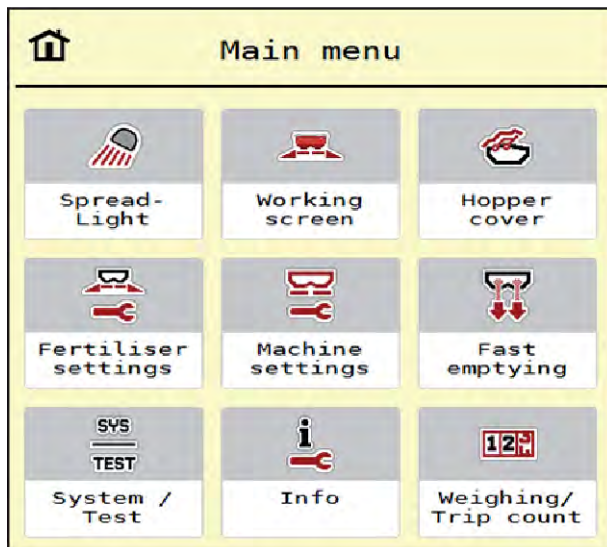

Fig. 9: Main menu with sub-menus

Sub-menu	Meaning	Description
SpreadLight	Activation/deactivation of operating lights	4.10 Operating lights (SpreadLight)
Working screen	Switches to the working screen	
Hopper cover	Opening/closing the hopper cover	4.11 Hopper cover
Fertiliser settings	Fertilizer and spreading operation settings	4.4 Fertilizer settings
Machine settings	Tractor and machine settings	4.5 Machine settings
Fast emptying	Direct access to menu for fast emptying of the machine	4.6 Fast emptying
System / Test	Settings and diagnosis of the machine control unit	4.7 System/Test
Info	Machine configuration display	4.8 Info
Weighing/Trip count.	Values regarding spreading work carried out and functions for weighing operation	4.9 Weighing/Trip counter

In addition to the sub-menus, in the main menu, the function keys Idle measurement and Bound.sprd.type can be selected.



- Idle measurement: This function key enables a manual start of the idle measurement. See chapter 5.7.2 *Manual idle measurement*.
- Bound. sprd.type: You can choose between full border spreading or limited border spreading.

## 4.4 Fertilizer settings



In this menu, the fertilizer and spreading settings can be changed.

- ▶ Access the menu Main menu > Fertiliser settings.



Not all parameters are displayed simultaneously on one screen. You can switch to the next or previous menu windows (tabs) using the **left/right arrow** keys.

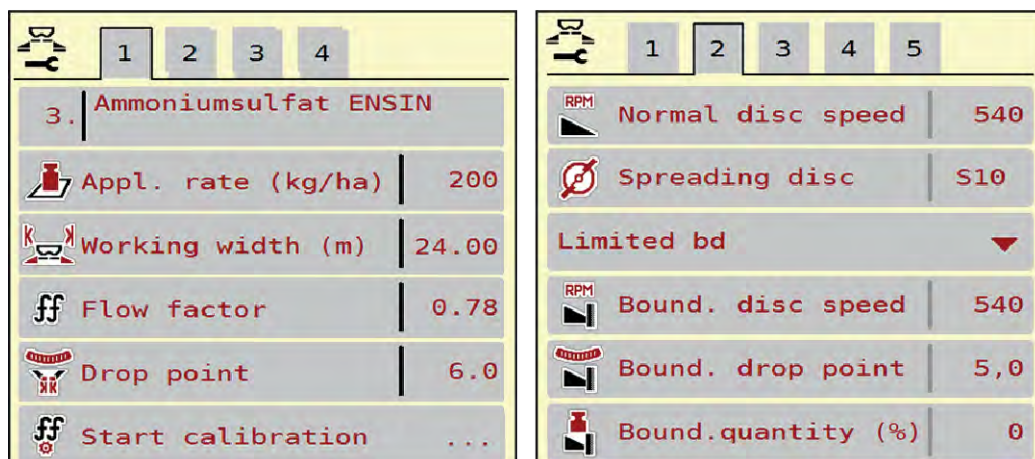

Fig. 10: Fertiliser settings AXIS-H EMC menu, tab 1 and 2

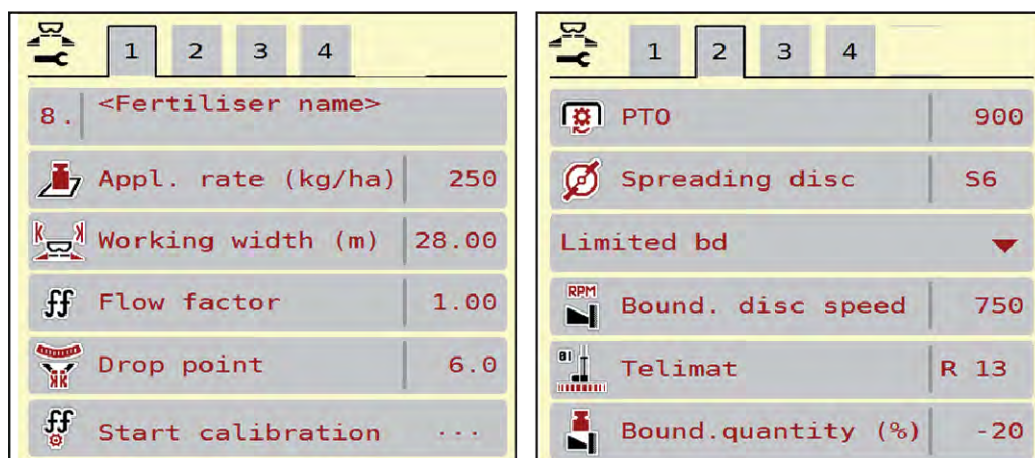

Fig. 11: Fertiliser settings menu, mechanical drive, tab 1 and 2

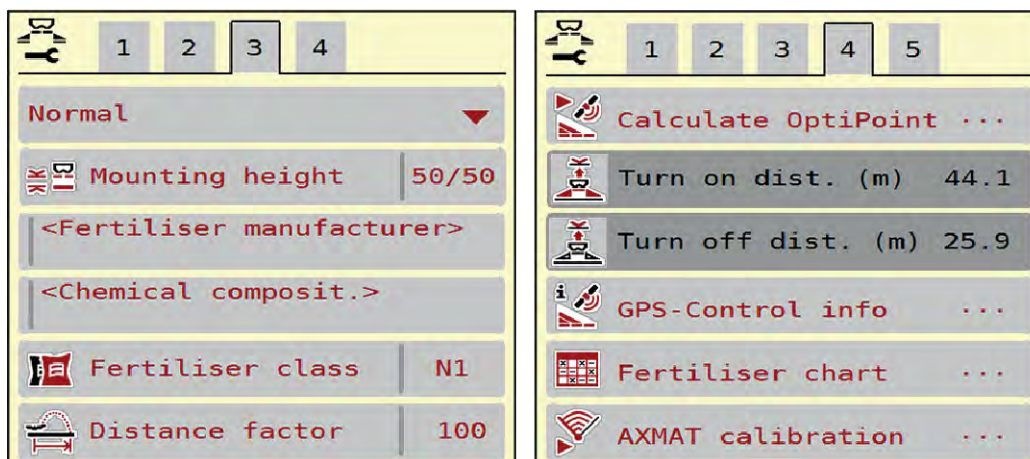

Fig. 12: Fertiliser settings menu, tab 3 and 4

Sub-menu	Meaning	Description
Fertiliser name	Fertilizer selected from the fertilizer chart	4.4.12 Fertilizer charts
Appl. rate (kg/ha)	Input of target value for the application rate in kg/ha	4.4.1 Application rate
Working width (m)	Determination of the working width to be spread	4.4.2 Setting the working width
Flow factor	Input of flow factor of the fertilizer used	4.4.3 Flow factor
Drop point	Input of the drop point For <b>AXIS with electrical drop point actuators</b> : Drop point adjustment	Please observe the operator's manual for the machine. 4.4.4 Drop point
Start calibration	Accessing the sub-menu for executing the calibration	4.4.5 Calibration test
Normal disc speed	<b>AXIS-H</b> Input of the desired spreading disc speed Influences the EMC mass flow control	4.4.7 Rotation speed
PTO	<b>AXIS-M</b> Influences the EMC mass flow control  Factory setting: <ul style="list-style-type: none"> <li>• AXIS-M 20.2/30.2: 540 rpm</li> <li>• AXIS-M 50.2: 750 rpm</li> </ul>	4.4.7 Rotation speed



Sub-menu	Meaning	Description
Spreading disc	Setting of the disc type mounted on the machine The setting influences the EMC mass flow control.	Selection list: <ul style="list-style-type: none"> <li>• S4</li> <li>• S6</li> <li>• S8</li> <li>• S10</li> <li>• S12</li> <li>• S1 (for all machine types except AXIS-M 50.2)</li> </ul>
Bound. sprd.type	Selection list: <ul style="list-style-type: none"> <li>• Limited bd</li> <li>• Full bord.</li> </ul>	Selection with arrow keys, confirmation with the Enter key
Bound. disc speed	Pre-setting the RPM in the boundary spreading mode	To be entered in a separate input window
Bound. drop point	Pre-setting the drop point in the boundary spreading mode	To be entered in a separate input window
Limit. bd rate (%)	Pre-setting the application rate reduction in boundary spreading mode	To be entered in a separate input window
TELIMAT	Saving the TELIMAT settings for boundary spreading	Only for AXIS-M machines with TELIMAT
Fertilisation method	Selection list: <ul style="list-style-type: none"> <li>• Normal</li> <li>• Late sprd.</li> </ul>	Selection with <b>arrow keys</b> Confirmation with the <b>Enter key</b>
Mounting height	Indicated in cm front/cm rear  Selection list: <ul style="list-style-type: none"> <li>• 0/6</li> <li>• 40/40</li> <li>• 50/50</li> <li>• 60/60</li> <li>• 70/70</li> <li>• 70/76</li> </ul>	
Manufacturer	Fertilizer manufacturer input	
Composition	Percentage of the chemical composition	
Fertilizer class	Selection list	Selection with arrow keys; Confirmation with the Enter key

Sub-menu	Meaning	Description
Distance factor	Input of the distance factor from the fertilizer chart. Required for OptiPoint calculation	
Calculate OptiPoint	Input of the GPS control parameters	4.4.10 Calculate OptiPoint
Turn on dist. (m)	Input of turn on distance	
Turn off dist. (m)	Input of turn off distance	
GPS-Control info	Display of information of the GPS Control parameters	4.4.11 GPS Control info
Fertiliser chart	Management of fertilizer charts	4.4.12 Fertilizer charts
Calibrate AXMAT	<b>AXIS-H 50.2 only</b> Open the sub-menu for calibration of the AXMAT function	Please observe the operator's manual for the special equipment

#### 4.4.1 Application rate



In this menu, enter the target value for the desired application rate.

##### Enter the application rate:

- ▶ Access the menu Fertiliser settings > Appl. rate (kg/ha).  
*The **currently applied** application rate is displayed.*
- ▶ Enter the new value in the input field.
- ▶ Press **OK** .  
*The new value is saved in the machine control unit.*

#### 4.4.2 Setting the working width



You can set the working width (in meters) in this menu.

- ▶ Access the menu Fertiliser settings > Working width (m).  
*The **currently applied** working width is displayed.*
- ▶ Enter the new value in the input field.
- ▶ Press **OK** .

*The new value is saved in the machine control unit.*



The working width cannot be adjusted whilst spreading is in progress.

### 4.4.3 Flow factor



The flow factor lies within the range of **0.2** to **1.9**.

With identical basic settings (km/h, working width, kg/ha), the following applies:

- If the flow factor is **increased**, the dosing quantity is **reduced**
- If the flow factor is **reduced**, the dosing quantity is **increased**

An error message is displayed if the flow factor is outside the preset range. See chapter 6 *Alarm messages and possible causes*.

If you are spreading organic fertilizer or rice, you need to reduce the minimum factor to 0.2. Otherwise the error message will be displayed constantly.

If you have obtained the flow factor from earlier calibrations or from the fertilizer chart, enter it manually in this selection window.



Via the Start calibration menu, the flow factor can be determined and entered using the control unit. Refer to Chapter 4.4.5 *Calibration test*

With the AXIS-H EMC mineral fertilizer spreader, the flow factor is calculated via the EMC mass flow control. However, the data may also be entered manually.



The flow factor calculation depends on the operating mode used. For further information about the flow factor, refer to chapter 4.5.1 *AUTO/MAN mode*.

#### Entering the flow factor:

- ▶ Access the menu Fertiliser settings > Flow factor.  
*The currently set flow factor is displayed.*
- ▶ Enter the value obtained from the fertilizer chart into the input field.



If your fertilizer is not listed in the fertilizer chart, enter a flow factor of **1.00**.  
In the AUTO km/h operating mode, we highly recommend executing a **calibration** in order to be able to accurately determine the flow factor for this fertilizer.

- ▶ Press OK.

*The new value is saved in the machine control unit.*



For the AXIS EMC mineral fertilizer spreader (AUTO km/h + AUTO kg operating mode), we recommend having the flow factor displayed on the working screen. By doing so, you are able to monitor the flow factor control during spreading. See chapter 2.2.2 *Display fields*.

#### 4.4.4 Drop point



With the AXIS EMC mineral fertilizer spreader, the drop point is set via the electrical drop point adjustment exclusively.

- ▶ Access the menu Fertiliser settings > Drop point.
- ▶ Determine the position for the drop point using the fertilizer chart.
- ▶ Enter the determined value in the input field.
- ▶ Press OK.

*The Fertiliser settings window appears with the new drop point.*

If the drop point is blocked, alarm 17 is displayed; refer to chapter 6 *Alarm messages and possible causes*.

#### ⚠ CAUTION!

##### **Risk of injury due to automatic adjustment of the drop point**

When the **Start/Stop** function key is pressed, the drop point is automatically moved to the preset value by an electrical actuator (Speedservo). This may cause injury.

- ▶ Before pressing the **Start/Stop** key, ensure that nobody is present in the hazard zone of the machine.
- ▶ Acknowledge the "Approach drop point" alarm message by pressing Start/Stop.

#### 4.4.5 Calibration test



The Start calibration menu is locked for weighing spreaders and all machines in the **operating mode** AUTO km/h + AUTO kg. This menu item is inactive.

In this menu, the flow factor can be determined based on a calibration and saved in the machine control unit.

Execute the calibration:

- Before spreading for the first time
- If the fertilizer quality has changed significantly (moisture, high dust content, granulate damage)
- If a new fertilizer type is used

The calibration must either be conducted with a running PTO at a standstill or while driving over a test section.

- Remove both spreading discs.
- Move the drop point to the calibration position (value 0).

#### Entering the working speed:

- ▶ Access the menu Fertiliser settings > Start calibration.
- ▶ Enter the average working speed.  
This value is required for calculation of the slider position during calibration.
- ▶ Press the Continue button.  
*The new value is saved in the machine control unit.*  
*The second calibration page is displayed.*



#### Select the section

- ▶ Set the spreader side on which the calibration is to be carried out.  
Press the function key of the left spreading side.  
Press the function key of the right spreading side.  
*The icon indicating the selected spreader side has a red background.*

#### **WARNING!**

##### **Risk of injury during calibration**

Rotating machine parts and discharged fertilizer could cause injury.

- ▶ Before starting the calibration, ensure that all requirements have been met.
- ▶ Observe the calibration chapter in the operator's manual for the machine.



- ▶ Press **Start/Stop**.

*The metering slide of the previously selected section opens and the calibration is started.*



The calibration can be stopped at any time by pressing the ESC key. The metering slide is closed and the display shows the Fertiliser settings menu.



The calibration time is not relevant to the accuracy of the results. However, a **minimum of 20 kg** should be calibrated.

- ▶ Press **Start/Stop** again.

*The calibration is completed.*

*The metering slide closes.*

*The third calibration page is displayed.*

#### ■ **Calculating the new flow factor**

#### **WARNING!**

##### **Risk of injury due to rotating machine parts**

Any contact with rotating machine parts (drive shaft, hubs) may lead to bruises, abrasions, and crushing injuries. Body parts or objects may be caught or drawn in.

- ▶ Switch off the tractor engine.
- ▶ Switch off the hydraulics system and secure it against unauthorized activation.

- ▶ Weigh the collected weight (taking into account the empty weight of the collecting vessel).
- ▶ Enter the weight under the **Calibrated quantity** menu entry.
- ▶ Press **OK**.

*The new value is saved in the machine control unit.*

*The **Flow factor calculation** menu is displayed.*



The flow factor must be between 0.4 and 1.9.

- ▶ Set the flow factor.  
In order to apply the newly calculated flow factor, press the Confirm flow factor button.  
To confirm the previously saved flow factor, press the **ESC** key.

*The flow factor is saved.*

*The “Approach drop point” alarm message is displayed.*

#### **⚠ CAUTION!**

##### **Risk of injury due to automatic adjustment of the drop point**

When the **Start/Stop** function key is pressed, the drop point is automatically moved to the preset value by an electrical actuator (Speedservo). This may cause injury.

- ▶ Before pressing the **Start/Stop** key, ensure that nobody is present in the hazard zone of the machine.
- ▶ Acknowledge the “Approach drop point” alarm message by pressing Start/Stop.

#### 4.4.6 Disc type



For optimal empty run measurement, check the correct input in the Fertiliser settings menu.

- The entries in the Spreading disc and Normal disc speed or PTO menu items must correspond to the actual settings of your machine.

The mounted spreading disc type has a default factory setting. If you have mounted different spreading discs on your machine, you must enter the correct type.

- ▶ Access the menu Fertiliser settings > Spreading disc.
- ▶ Activate the spreading disc type in the selection list.

*The Fertiliser settings window is displayed with the new spreading disc type.*

#### 4.4.7 Rotation speed

- **PTO**



For optimal empty run measurement, check the correct input in the Fertiliser settings menu.

- The entries in the Spreading disc and PTO menu items must correspond to the actual settings of your machine.

The specified PTO speed is preset in the control unit to 750 rpm as a standard factory setting. If you want to specify a different PTO speed, you must change the saved value in the control unit.

- ▶ Access the menu Fertiliser settings > PTO.
- ▶ Enter the speed in rpm.

*The Fertiliser settings window is displayed with the new PTO speed.*



Please observe Chapter 5.6 *Spreading with the automatic operating mode (AUTO km/h + AUTO kg)*.

#### ■ **Normal disc speed**



For optimal empty run measurement, check the correct input in the Fertiliser settings menu.

- The entries in the Spreading disc and Normal disc speed menu items must correspond to the actual settings of your machine.

The factory default speed is set to 750 rpm. If you want to set a different speed, you must change the saved value.

- ▶ Access the menu Fertiliser settings > Normal disc speed.
- ▶ Enter the speed value.

*The Fertiliser settings window is displayed with the new speed.*



Please observe Chapter 5.6 *Spreading with the automatic operating mode (AUTO km/h + AUTO kg)*.



## 4.4.8 Boundary spreading mode

### AXIS-H only

In this menu, you can select a suitable spreading mode at the field boundary.

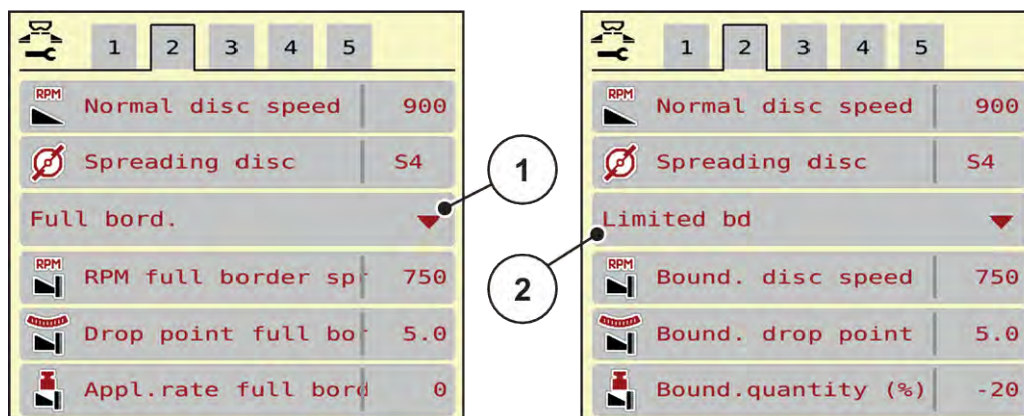

Fig. 13: Setting values for boundary spreading mode

[1] Full border spreading

[2] Limited border spreading

- ▶ Access the menu Fertiliser settings.
- ▶ Switch to tab 2.
- ▶ Select the boundary spreading mode Full bord. or Limited bd.
- ▶ If required, adjust the RPM, Drop point or quantity reduction in accordance with the information provided in the fertilizer chart.

## 4.4.9 Boundary spreading quantity



In this menu, you can reduce quantity value (as a percentage). This setting is used for the activation of the boundary spreading function and/or the TELIMAT unit (AXIS-M only).



We recommend reducing the quantity on the boundary spreading side by 20 %.

### Entering the boundary spreading quantity:

- ▶ Access the menu Fertiliser settings > Limit. bd rate (%).
- ▶ Enter the value in the input field and confirm.

*The Fertiliser settings window is displayed with the new boundary spreading quantity.*

#### 4.4.10 Calculate OptiPoint



In the Calculate OptiPoint menu, you can enter the parameters to calculate the optimum turn-on and turn-off distances in the headlands. For an accurate calculation, it is very important to enter the distance factor for the fertilizer used.



For the aerodynamic factor of the fertilizer used please refer to the fertilizer chart of the machine.

- ▶ Enter the required value in the menu Fertiliser settings > Distance factor.
- ▶ Access the menu Fertiliser settings > Calculate OptiPoint.  
*The first page of the Calculate OptiPoint menu is displayed.*



The indicated forward speed refers to the forward speed in the area of the switching positions! See chapter 5.11 GPS control.

- ▶ Enter the average forward speed in the range of switching positions.  
*The second page of the menu is displayed.*
- ▶ Press OK.
- ▶ Press the Continue button.  
*The third page of the menu is displayed.*

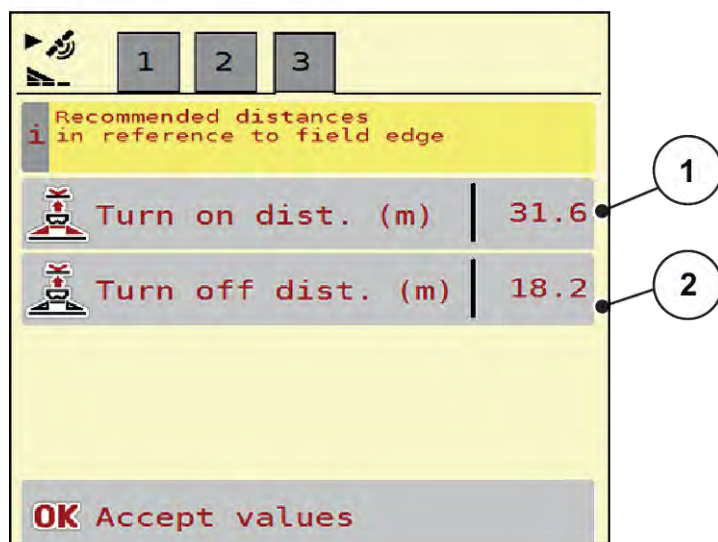

Fig. 14: Calculate OptiPoint, page 3

Number	Meaning	Description
[1]	Distance from the field border (in meters) at which the metering slides open.	<i>Fig. 47 Distance on (measured from field border)</i>
[2]	Distance from the field border (in meters) at which the metering slides close.	<i>Fig. 48 Distance off (measured from field border)</i>



On this page, you can manually adjust the parameters. See chapter 5.11 *GPS control*.

#### Changing the values

- ▶ Open the desired list entry.
- ▶ Enter the new values.
- ▶ Press OK.
- ▶ Press the Accept values button.

*The OptiPoint is calculated.*

*The machine control unit switches to the GPS-Control info window.*

#### 4.4.11

#### GPS Control info



The GPS-Control info menu informs you of the calculated setting values in the Calculate OptiPoint menu.

Depending on the terminal used, the display will show 2 distances (CCI, Müller Elektronik) or 1 distance and 2 time values (John Deere, etc.).

- With most ISOBUS terminals, the values displayed here are applied automatically to the corresponding settings menu of the GPS terminal.
- With some terminals, however, a manual entry is required.



This menu is for information purposes only.

- See the operating manual for your GPS terminal.

- ▶ Access the menu Fertiliser settings > GPS-Control info.

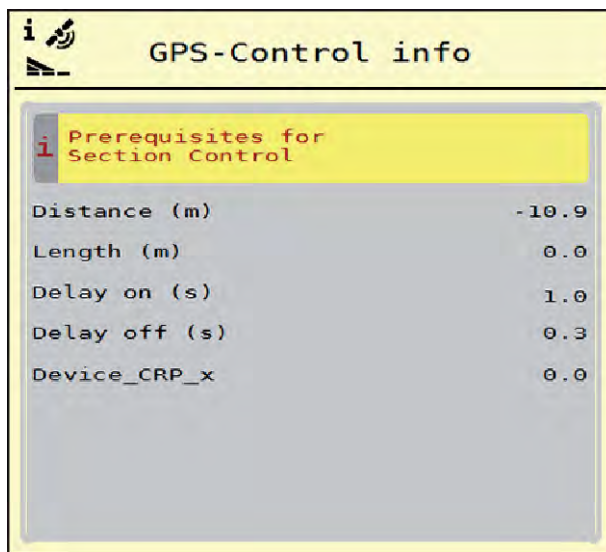

Fig. 15: Menu GPS-Control info

#### 4.4.12 Fertilizer charts



In this menu, you can create and manage your own fertilizer charts.



Selecting a fertilizer chart affects the machine, fertilizer settings and the machine control unit. The set application rate is overwritten by the stored value from the fertilizer chart.

##### Creating a new fertilizer chart

You can create up to 30 fertilizer charts in the electronic machine control unit.

- ▶ Access the menu Fertiliser settings > Fertiliser charts.

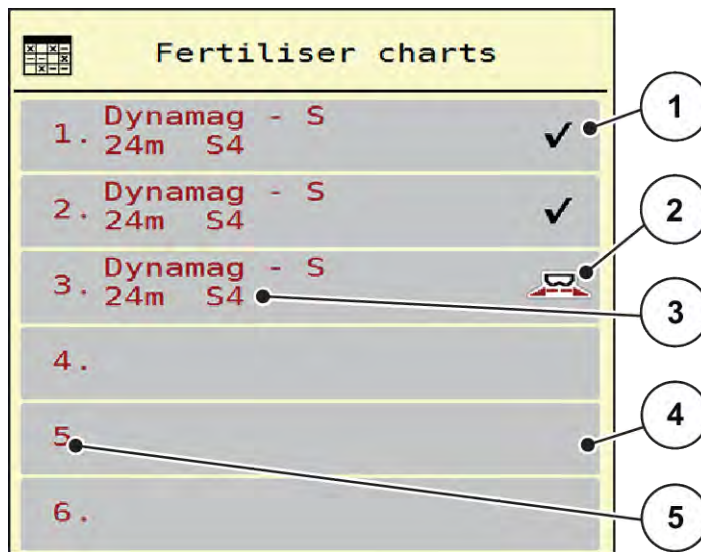

Fig. 16: Menu Fertiliser charts

- [1] Indicates a fertilizer chart filled with values
- [2] Indicates an active fertilizer chart
- [3] Fertilizer chart name field
- [4] Empty fertilizer chart
- [5] Chart number

- ▶ Select an empty fertilizer chart.

The name field consists of the fertilizer name, the working width and the spreading disc type.

*The display shows the selection window.*

- ▶ Press the option Open and back to fertiliser settings.

*The Fertiliser settings menu is displayed and the selected element is loaded into the fertilizer settings as the active fertilizer chart.*

- ▶ Select the Fertiliser name menu item.
- ▶ Enter a name for the fertilizer chart.



We recommend naming the fertilizer chart after the fertilizer. Specific fertilizers can thus be assigned to fertilizer charts more easily.

- ▶ Edit the parameters of the fertilizer chart. See 4.4 Fertilizer settings.

### Selecting a fertilizer chart

- ▶ Access the menu Fertiliser settings > Open and back to fertiliser settings.
- ▶ Select the desired fertilizer chart.  
*The display shows the selection window.*
- ▶ Select the option Open and back to spreading mat. settings.

*The Fertiliser settings menu is displayed and the selected element is loaded into the fertilizer settings as the active fertilizer chart.*



When selecting an existing fertilizer chart, all values in the Fertiliser settings menu will be overwritten with the stored values obtained from the selected fertilizer chart, including the drop point and the normal disc speed.

- The machine control unit will move the drop point to the value stored in the fertilizer chart.

### Copying an existing fertilizer chart

- ▶ Select the desired fertilizer chart.  
*The display shows the selection window.*
- ▶ Select the option Copy element.

*A copy of the fertilizer chart is now in the first free position on the list.*

### Deleting an existing fertilizer chart

- ▶ Select the desired fertilizer chart.  
*The display shows the selection window.*



The active fertilizer chart cannot be deleted.

- ▶ Select the option Delete element.  
*The fertilizer chart is deleted from the list.*

### ■ **Managing the selected fertilizer chart via the working screen**

You can also manage the fertilizer chart directly via the operating screen



## 4.5 Machine settings



In this menu, you can enter settings for the tractor and the machine.

- ▶ Access the menu Machine settings.

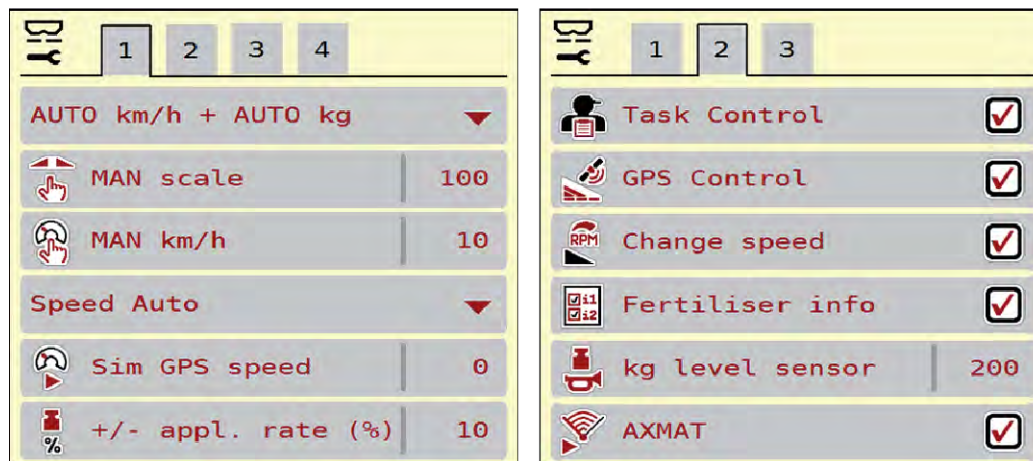

Fig. 18: Machine settings menu, tab 1 and 2

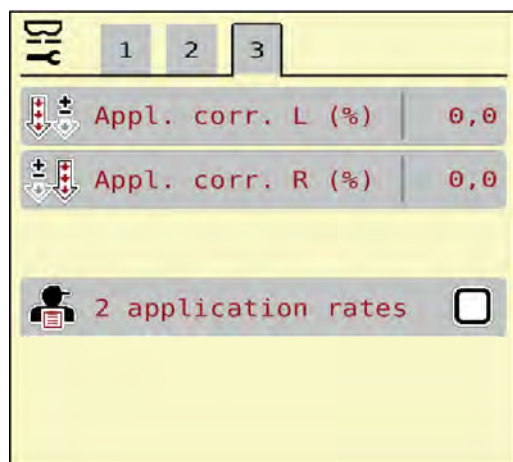

Fig. 19: Machine settings menu, tab 3



Not all parameters are displayed simultaneously on one screen. You can switch to the next or previous menu windows (tabs) using the left/right arrow keys.

Sub-menu	Meaning	Description
AUTO/MAN mode	Specifying automatic or manual operating mode	4.5.1 AUTO/MAN mode



Sub-menu	Meaning	Description
MAN scale	Setting the manual scale value. (only influences the respective operating mode)	To be entered in a separate input window.
MAN km/h	Setting the manual speed. (only influences the respective operating mode)	To be entered in a separate input window.
Speed/signal source	Selection/limitation of the speed signal <ul style="list-style-type: none"> <li>• Speed AUTO (automated selection of either transmission or radar/GPS)<sup>1</sup></li> <li>• GPS J1939 <sup>1</sup></li> <li>• NMEA 2000</li> </ul>	
Sim GPS speed	For GPS J1939 only: Indication of forward speed in the event of loss of the GPS signal	<b>NOTE!</b> The entered forward speed is to be maintained constantly at all times.
+/- appl. rate (%)	Pre-setting the application rate change for the different spreading types	To be entered in a separate input window
Task Control	Activation of the ISOBUS Task Controller functions for documentation and for application map spreading <ul style="list-style-type: none"> <li>• Task Control on (checked)</li> <li>• Task Control off</li> </ul>	
GPS-Control	Activation of the function to control the machine sections via GPS control unit <ul style="list-style-type: none"> <li>• Task Control on (checked)</li> <li>• Task Control off</li> </ul>	

<sup>1)</sup> The manufacturer does not assume any liability in the event of a loss of the GPS signal.

Sub-menu	Meaning	Description
Change speed	<b>AXIS-H only</b> Activation of the function for changing the speed in the boundary spreading mode in the working screen. If this function is deactivated, the change can only be made as a percentage value (%).	
Fertilizer info	Activation of the fertilizer information (fertilizer name, spreading disc type, working width) in the working screen.	
kg level sensor	Input of the remaining quantity to trigger an alarm message via the weigh cells	
AXMAT	<b>AXIS-H 50 only</b> Activate the AXMAT function	Please observe the operator's manual for the special equipment.
Appl. corr. L (%) Appl. corr. R (%)	Correction of the deviations between the entered application rate and the actual application rate  • Correction in percent on the right and/or left side	
2 application rates	Only when working with application maps: Activation of two separate application rates for the right and left side, respectively	

#### 4.5.1 AUTO/MAN mode

The machine control unit automatically adjusts the dosing quantity according to the speed signal. This adjustment is influenced by the application rate, working width, and flow factor.

By default, the unit is operated in the **automatic** mode.

You only work in **manual** mode in the following cases:

- If there is no speed signal (radar or wheel sensor not available or defective)
- Application of slug pellets or seeds (fine seeds)



For uniform spreading of the spreading material, a **constant forward speed** must be applied in manual operating mode.



Spreading in different operating modes is described in *5 Spreading operation*.

Menu	Meaning	Description
AUTO km/h + AUTO kg	Selecting automatic mode with automatic weighing	Page 81
AUTO km/h	Selecting automatic mode	Page 84
MAN km/h	Adjustment of forward speed for manual mode	Page 85
MAN scale	Dosing slide adjustment for manual mode This operating mode is suitable for spreading slug pellets or fine seeds.	Page 86

### Operating mode selection

- ▶ Start the machine control unit.
- ▶ Access the menu Machine settings > AUTO/MAN mode.
- ▶ Select the desired menu item from the list.
- ▶ Press OK.
- ▶ Follow the instructions on the screen.



We recommend having the flow factor displayed in the working screen. By doing so, you can observe the mass flow control during spreading. See *2.2.2 Display fields*.

- Important information on the use of operating modes for spreading operations is provided in chapter *5 Spreading operation*.

### 4.5.2 +/- quantity



In this menu, you can set the percentage increment of the **application rate change** for normal spreading.

The base value (100%) is the preset value for the metering slider opening.





During operation, the Quantity +/-Quantity - function keys can be used to adjust the application rate by the +/- Quantity factor at any time. The pre-configuration can be reset with the C 100 % key.

**Specifying the application rate reduction:**

- ▶ Access the menu Machine settings > +/- appl. rate (%).
- ▶ Enter the percentage by which the application rate is to be adjusted.
- ▶ Press OK.

## 4.6 Fast emptying



In order to quickly clean the machine after spreading or to quickly empty any residual material, you can select the Fast emptying menu.

For this purpose, before storing the machine, we recommend **completely opening** the metering slides with the fast emptying function and switching off the control unit in this state. This prevents the accumulation of humidity in the hopper.



**Before starting** the fast emptying process, care must be taken to ensure that all requirements have been met. Observe the operator's manual for the mineral fertilizer spreader (discharging residual material).

**Carrying out the fast emptying process:**

- ▶ Access the menu Main menu > Fast emptying.

**⚠ CAUTION!**

**Risk of injury due to automatic adjustment of the drop point**

With **AXIS EMC**, the Approach drop point Yes = Start alarm message appears. When you press the Start/Stop function key, the drop point automatically moves to position 0. After the calibration, the drop point automatically moves to the preset value again. This may cause injury and property damages.

- ▶ Before pressing the Start/Stop key, ensure that **nobody** is present in the hazard zone of the machine.

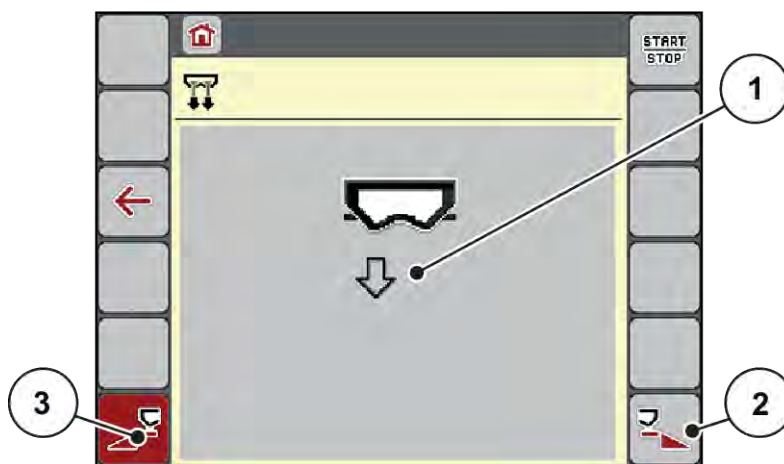

Fig. 20: Menu Fast emptying

- [1] Icon for fast emptying (here: left side selected, not started)
- [2] Fast emptying of the right section (not selected)
- [3] Fast emptying of the left section (selected)

- ▶ Press the **function key** to select the section for which the fast emptying function is to be carried out.

*The selected section is displayed as an icon (Fig. 20 position [3]).*

- ▶ Press **Start/Stop**.

*The fast emptying process starts.*

- ▶ Press **Start/Stop** when the hopper is empty.

*Fast emptying is complete.*

- ▶ ESC to return to the Main menu.

**⚠ CAUTION!****Risk of injury due to automatic adjustment of the drop point**

With **AXIS EMC**, the Approach drop point Yes = Start alarm message appears. When you press the Start/Stop function key, the drop point automatically moves to position 0. After the calibration, the drop point automatically moves to the preset value again. This may cause injury and property damages.

- ▶ Before pressing the Start/Stop key, ensure that **nobody** is present in the hazard zone of the machine.

Before storage, you can completely empty the hopper of your machine via the machine control unit.

**Complete discharge:**

- ▶ Select both sections.
- ▶ Press **Start/Stop**.

*Both metering slides open.*

*The drop point moves to the left and to the right, to the value 0.*



- ▶ Press and hold the Complete discharge button.  
*The drop point moves between the values 9.5 and 0 to allow the fertilizer to flow out.*
- ▶ Release the **Complete discharge** button.  
*The left and right drop point moves back to the value 0.*
- ▶ Press **Start/Stop**.  
*The drop point automatically moves to the pre-set value.*

**4.7 System/Test**

In this menu, the system and test settings for the machine control unit can be configured.

- ▶ Access the menu Main menu > System / Test.

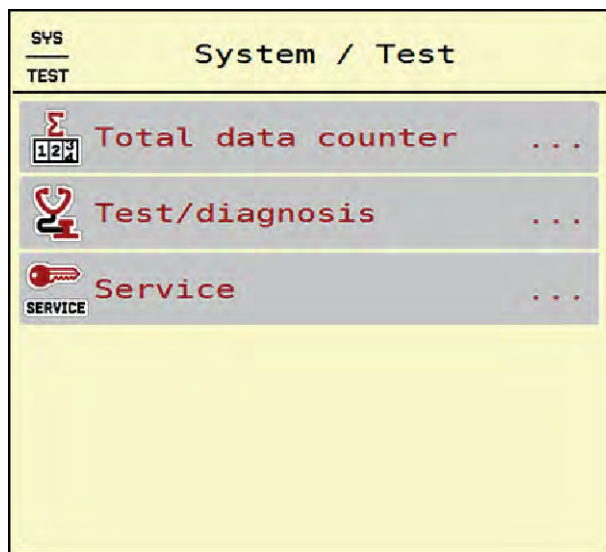

Fig. 21: Menu System / Test

Sub-menu	Meaning	Description
Total data counter	Display list <ul style="list-style-type: none"> <li>• spread quantity in kg</li> <li>• spread area in ha</li> <li>• spread time in h</li> <li>• distance traveled in km</li> </ul>	4.7.1 <i>Total data counter</i>
Test/diagnosis	Checking of actuators and sensors	4.7.2 <i>Test/diagnosis</i>
Service	Service settings	Password-protected; only accessible for service personnel

#### 4.7.1 Total data counter



In this menu, all of the spreader's counter readings are displayed.

- spread quantity in kg
- spread area in ha
- spread time in h
- distance traveled in km



This menu is for information purposes only.

Σ Total data counter	
kg calculated	712168
ha	1902.4
hours	93
km	673

Fig. 22: Menu Total data counter

#### 4.7.2 Test/diagnosis



In the Test/diagnosis menu, you can check the functions of all actuators and sensors.



This menu is for information purposes only.

The list of sensors depends on the equipment of the machine.

#### ⚠ CAUTION!

##### Risk of injury due to moving machine parts

During the tests, machine parts may move automatically.

- ▶ Before carrying out the tests, ensure that nobody is present in the danger zone of the machine.

Sub-menu	Meaning	Description
Voltage	Checking the operating voltage	
Metering slider	Moving the left and right metering slides	<i>Example: metering slides</i>
Test points slider	Test for approaching the various position points of the metering slides	Calibration check
Drop point	Manual movement of the drop point motor	
Test points drop pt.	Approaching the drop point	Calibration check



Sub-menu	Meaning	Description
LIN bus	Checking the assemblies registered via LIN bus	<i>Example: LIN bus</i>
Spreading disc	Manual activation of the spreading disc	
Agitator	Checking the agitator	
EMC sensors	Checking the EMC sensors	
Weigh cell	Checking the sensors	
Level sensor	Checking the level sensors	
AXMAT sensor status	Checking the sensor system	
Hopper cover	Checking the actuators	
SpreadLight	Checking the operating lights	

■ **Example: metering slides**

► Access the menu Test/diagnosis > Metering slider.

*The status of the motors/sensors is displayed.*

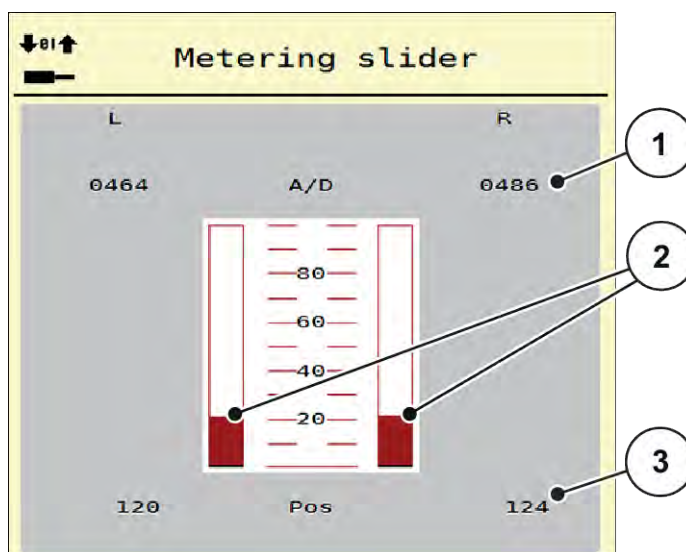

Fig. 23: Test/diagnosis; Example: Metering slider

[1] Signal display  
[2] Signal bar graph

[3] Position display

The Signal display shows the status of the electrical signals for the left and right side separately.

**⚠ CAUTION!****Risk of injury due to moving machine parts**

During the tests, machine parts may move automatically.

- ▶ Before carrying out the tests, ensure that nobody is present in the danger zone of the machine.

You can open and close the metering sliders with the up/down arrows.

■ **Example: LIN bus**

- ▶ Access the menu System / Test > Test/diagnosis.
- ▶ Select the LIN bus menu item.

The display shows the status of the actuators/sensors.

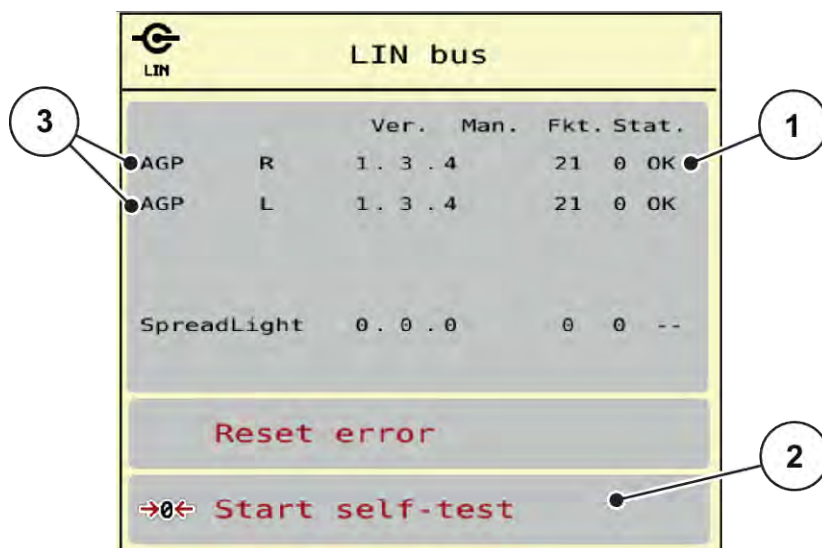

Fig. 24: System / Test; Example: Test/diagnosis

[1] Status display

[3] Connected equipment

[2] Start self-test

**Linbus participant status notification**

The devices indicate various conditions:

- 0 = OK; no equipment error
- 2 = blockage
- 4 = overload

**⚠ CAUTION!****Risk of injury due to moving machine parts**

During the tests, machine parts may move automatically.

- ▶ Before carrying out the tests, ensure that nobody is present in the danger zone of the machine.



When the system is restarted, the status is checked and typically reset. Since the status is not always reset automatically in certain cases, it is now also possible to perform a manual RESET.

- Press the Reset error button.

### 4.7.3 Service



An input code is required to configure the settings in the Service menu. These settings can only be modified by authorized service personnel.

## 4.8 Info



The Info menu provides information on the machine control unit.



This menu provides information on the configuration of the machine.

The information list depends on the equipment of the machine.

## 4.9 Weighing/Trip counter



This menu provides values regarding spreading work carried out and functions for the weighing operation.

- ▶ Access the menu Main menu > Weighing/Trip count..

*The Weighing/Trip count. menu appears.*

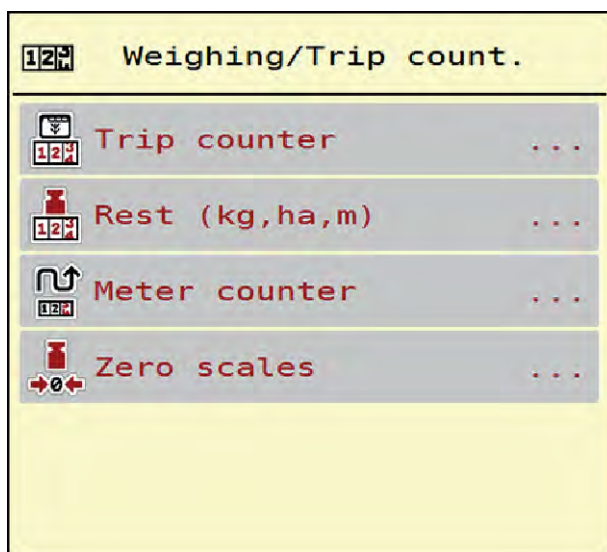

Fig. 25: Menu Weighing/Trip count.

Sub-menu	Meaning	Description
Trip counter	Display of the fertilizer quantity spread, area spread, and spread distance	4.9.1 Trip counter
Rest (kg, ha, m)	For weighing spreaders only: Display of the remaining quantity in the hopper	4.9.2 Rest (kg, ha, m)
Meter counter	Display of the distance traveled since the last reset of the meter counter	Reset (zeroing) by pressing the <b>C 100%</b> key
Zero scales	For weighing spreaders only: Weighing value for empty scales is set to "0 kg"	4.9.3 Zero scales

### 4.9.1 Trip counter



In this menu, the values of the spreading work carried out can be obtained, the remaining spreading quantity can be observed, and the trip counter can be reset by deleting.

- ▶ Access the menu Weighing/ Trip count > Trip counter.

*The Trip counter menu appears.*

During spreading, i. e. with the metering slides being open, you can switch to the Trip counter menu and obtain the current values there.



If you wish to continuously observe the values during spreading, you may also assign the freely selectable display fields in the working screen kg trip, ha trip or m trip, see 2.2.2 *Display fields*.

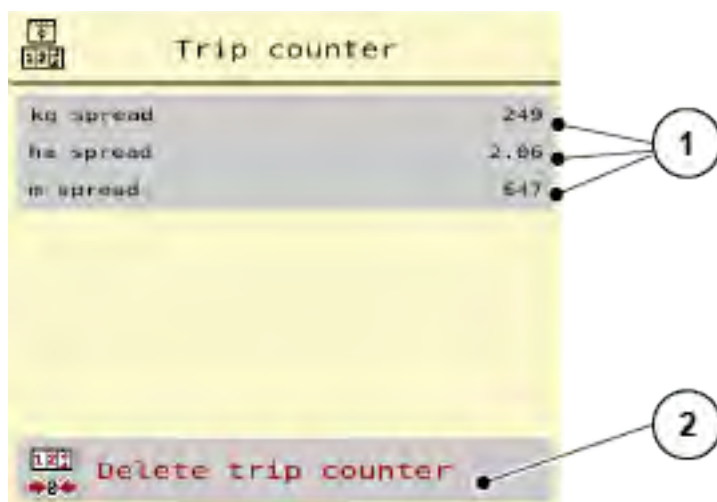

Fig. 26: Menu Trip counter

- [1] Spread quantity, area and distance display [2] Delete trip counter fields

#### Clear trip counter

- ▶ Access the sub-menu Weighing/Trip count. > Trip counter.  
*The values for spread quantity, area, and distance calculated since the last deletion are displayed.*
- ▶ Press the Delete trip counter button.

*All values of the trip counter are reset to 0.*

#### 4.9.2 Rest (kg, ha, m)



In the Rest (kg, ha, m) menu, you can obtain the remaining quantity in the hopper. The menu indicates the possible area (ha) and distance (m) which can still be spread with the remaining fertilizer quantity.

- ▶ Access the menu Weighing/Trip count. > Rest (kg, ha, m).

*The Rest (kg, ha, m) menu appears.*



The current fill weight **in the weighing spreader can only be determined by weighing**. In all other spreaders, the remaining fertilizer quantity is calculated from the fertilizer and machine settings as well as from the drive signal, and the filling quantity must be entered manually (see below). The Application rate and Working width values cannot be changed in this menu. They are for information purposes only.

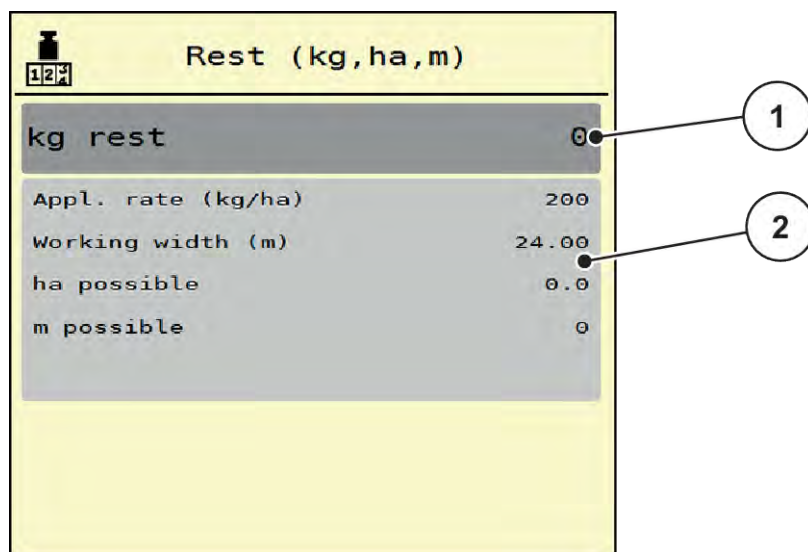

Fig. 27: Menu Rest (kg, ha, m)

[1] Input window kg rest

[2] Application rate, Working width, possible spread area and distance display fields

#### For machines without weigh cells

- ▶ Fill the hopper.
- ▶ In the Rest (kg) area, enter the total weight of the fertilizer left in the hopper.

*The unit calculates the values for the possible spread area and distance.*

### 4.9.3 Zero scales

#### ■ For weighing spreaders only



In this menu, set the weighing value for the empty hopper to 0 kg.

For taring the scales, the following requirements have to be fulfilled:

- the hopper is empty,
- the machine is at a standstill,
- the PTO is switched off,
- the machine is in a horizontal position and off the ground,
- the tractor is at a standstill.

#### Zero scales:

- ▶ Access the menu Weighing/Trip count. > Zero scales.
- ▶ Press the Zero scales button.

*The weighing value for the empty scales is now set to 0 kg.*



Tare the scales before each use in order to ensure problem-free calculation of the remaining quantity.

## 4.10 Operating lights (SpreadLight)



In this menu, you can activate the SpreadLight function, to monitor the spreading pattern even in night mode.

You can switch the operating lights on and off in the automatic and/or manual mode via the machine control unit.

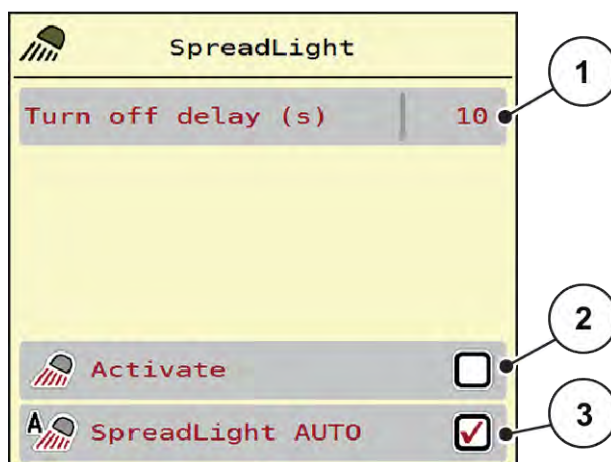

Fig. 28: Menu SpreadLight

[1] Turn off delay (s)

[3] Activate automatic mode

[2] Manual mode: Switch on operating lights



### Automatic mode:

In the automatic mode, the operating lights are switched on as soon as the metering slides open and the spreading process starts.

- ▶ Access the menu Main menu > SpreadLight.
- ▶ Put a check mark in the menu item SpreadLight AUTO [3].  
*The operating lights are switched on when the metering slides open.*
- ▶ Enter a turn off duration [1] in seconds.  
*The operating lights will switch off at the end of the entered time, if the metering slides are closed.*  
*Range from 0 to 100 seconds.*
- ▶ Remove the check mark in the menu item SpreadLight AUTO [3].  
*The automatic mode is deactivated.*



**Manual mode:**

In the manual mode, the operating lights can be switched on and off.

- ▶ Access the menu Main menu > SpreadLight.
- ▶ Put a check mark in the menu item Activate [2].

*The operating lights are activated and remain on until you remove the check mark or leave the menu.*

## 4.11 Hopper cover

**! WARNING!**

**Danger of crushing and shearing due to externally-actuated components**

The hopper cover will move without warning and can cause personal injury.

- ▶ Ensure that nobody is present in the hazard zone.

The AXIS EMC machine is equipped with an electrically operated hopper cover. During the refilling process at the end of the field, you can open and close the hopper cover using the control unit and an electrical drive.



The menu is only used for operating the actuators which open or close the hopper cover. The AXIS EMC ISOBUS control unit does not detect the exact position of the hopper cover.

- Monitor the movement of the hopper cover.



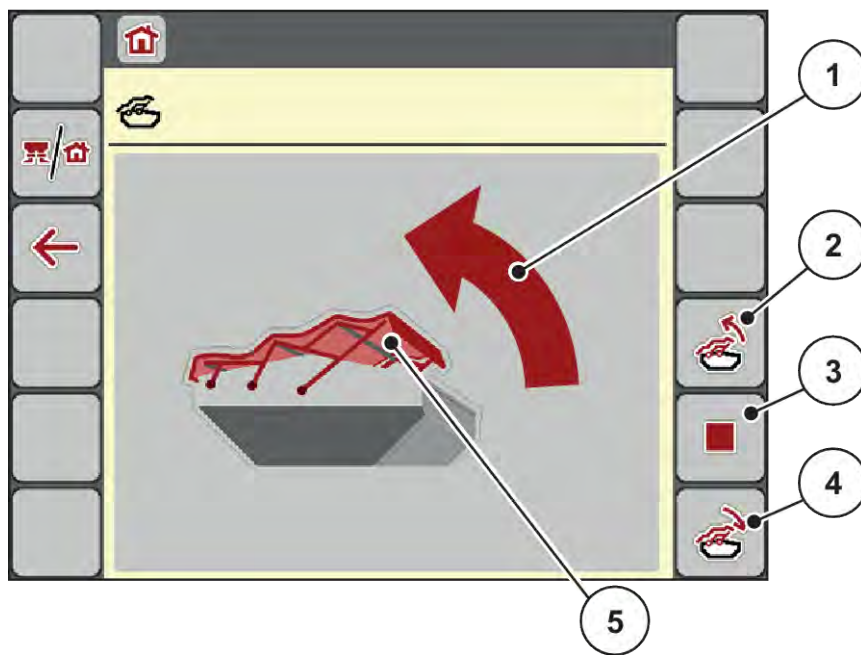

Fig. 29: Hopper cover menu

- |                             |  |
|-----------------------------|--|
| [1] Opening process display | [4] Close hopper cover                 |
| [2] Open hopper cover       | [5] Static display of the hopper cover |
| [3] Stop process            |  |

### ⚠ CAUTION!

#### Material damage due to insufficient clearance

To allow the hopper cover to be opened and closed, it requires a sufficient clearance above the hopper. If the clearance is insufficient, the hopper cover may tear. The lever of the hopper cover may be broken and the hopper cover may damage the environment.

- ▶ Ensure that the hopper cover has sufficient clearance.

#### Moving the hopper cover

- ▶ Press the **Menu** key.
- ▶ Access the menu Hopper cover.
- ▶ Press the **Open hopper cover** key.
  - During the movement, an arrow appears which indicates the **OPEN** direction.*
  - The hopper cover will open fully.*
- ▶ Pour in fertilizer.
- ▶ Press the **Close hopper cover** key.
  - During the movement, an arrow appears which indicates the **CLOSE** direction.*
  - The hopper cover will be closed.*





If required, you can stop the movement of the hopper cover by pressing the Stop key. The hopper cover then remains in the intermediate position until you close or open it completely.

## 4.12 Special functions

### 4.12.1 Changing the system of units

Your system of units has been preset at the factory. However, the system can be changed from metric to English units at any time.



Due to the great variety of different ISOBUS-compatible terminals, this chapter is limited to the functions of the electronic machine control system without indicating a specific ISOBUS terminal.

- Please observe the instructions for the operation of your ISOBUS terminal in the corresponding operator's manual.



- ▶ Open the Settings menu for the terminal system.
- ▶ Access the menu Unit.
- ▶ Select the desired unit system from the list.
- ▶ Press OK.

*All values of the various menus are converted.*

Menu/value	Conversion of metric to imperial units
kg left	1 x 2.2046 lb.-mass (lbs left)
ha left	1 x 2.4710 ac (ac left)
Working width (m)	1 x 3.2808 ft
Rate (kg/ha)	1 x 0.8922 lbs/ac
Mounting height cm	1 x 0.3937 in

Menu/value	Conversion of metric to imperial units
lbs left	1 x 0.4536 kg
ac left	1 x 0.4047 ha
Working width (ft)	1 x 0.3048 m
Appl. rate (lb/ac)	1 x 1.2208 kg/ha
Mounting height in	1 x 2.54 cm

### 4.12.2 Using the joystick

As an alternative to the settings in the working screen of the ISOBUS terminal, you may also use a joystick.



If you wish to use a different joystick, please contact your dealer.

- Please observe the instructions in the operator's manual of the ISOBUS terminal.

#### ■ CCI A3 joystick



Fig. 30: CCI A3 Joystick, front and rear

- |                         |                                |
|-------------------------|--------------------------------|
| [1] Light sensor        | [3] Plastic grid (replaceable) |
| [2] Display/touch panel | [4] Shift key                  |

#### ■ CCI A3 Joysticks operating levels

You can switch between three operating levels with the shift key. The level that is currently active is displayed by the positioning of a light strip at the bottom edge of the display.

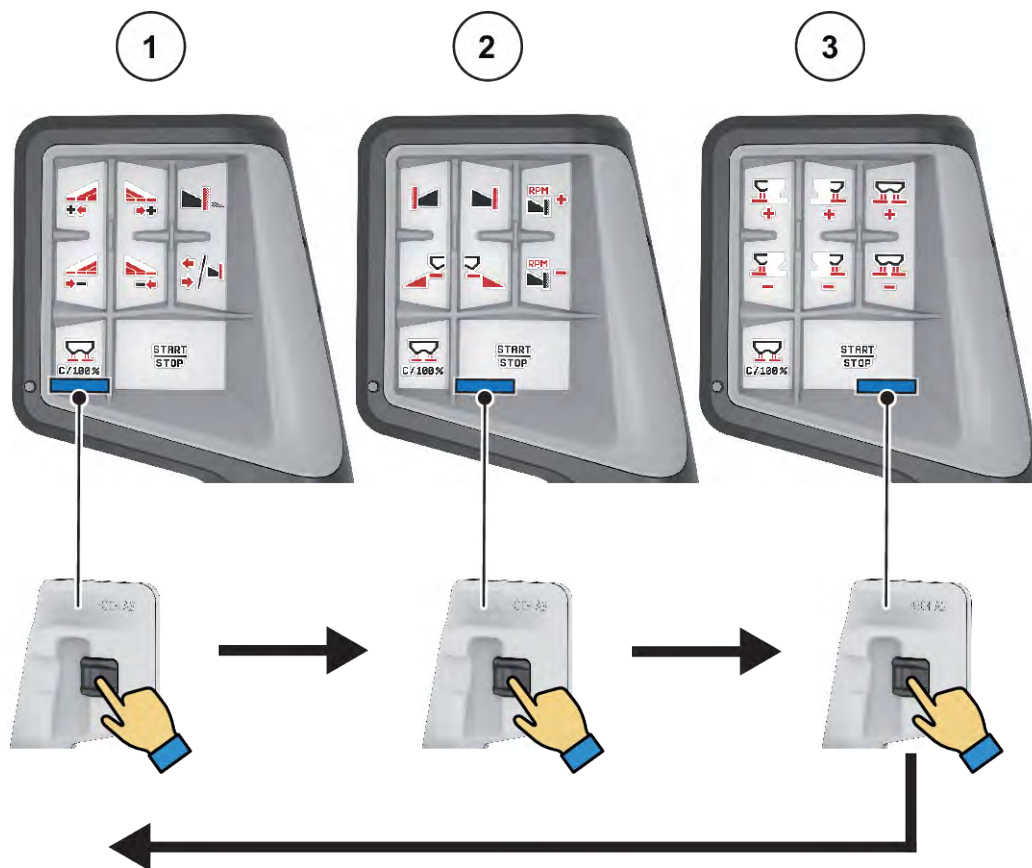

Fig. 31: CCI A3 joystick, operating level display

- [1] Level 1 active
- [2] Level 2 active

[3] Level 3 active

■ **CCI A3 joystick button functions**

The joystick offered is pre-programmed with specific functions at the factory.



The meaning and function of the icons can be found in Chapter 2.3 *Library of icons used*.  
Please note that the functions of the buttons vary depending on machine type (AXIS-M, AXIS-H).



Fig. 32: Button functions Level 1



Fig. 33: Button functions Level 2



Fig. 34: Button functions Level 3



If you would like to adjust the button functions on the three levels, please note the instructions in the joystick operator's manual.

### 4.12.3

#### WIFI module

##### ■ *Special equipment*

A WiFi module can be used for communication between a smartphone and the ECU. The following functions are possible:

- Transmission of information from the fertilizer charts app to the ECU. This way, the fertilizer settings no longer need to be entered manually.
- Transmission of the residual material weight display from the ECU on the smartphone.



Fig. 35: WiFi module



You can find more information on assembly of the WiFi module and communication with the smartphone in the WiFi module assembly instructions.

- The WiFi password is: **quantron**.

## 5 Spreading operation

The machine control unit helps you to enter the machine settings before starting work. During spreading, functions of the machine control unit are also active in the background. This allows you to monitor the quality of the fertilizer spreading.

### 5.1 Requesting the remaining quantity during spreading

#### ■ *For weighing spreaders only*

During spreading, the remaining quantity is continuously recalculated and displayed.

**During spreading**, i.e. with the dosing slides being open, you can switch to the Trip counter menu and read off the remaining quantity currently in the hopper.

During spreading, the remaining quantity is continuously recalculated and displayed.



If the values are to be permanently monitored during spreading, freely assignable display fields in the operating screen can also be assigned the kg left, ha left or m left values, refer to Chapter 2.2.2 *Display fields*.

#### **Working with the weighed remaining quantity, refilling the hopper:**

- ▶ Tare the scales.  
See chapter 4.9.3 *Zero scales*.
- ▶ Select the fertilizer type used.  
See chapter 4.4.12 *Fertilizer charts*.
- ▶ Fill the hopper.
- ▶ Weigh the fertilizer quantity in the hopper.
- ▶ Start your work.

#### **When the hopper is empty, refill it:**

- ▶ Fill the hopper.
- ▶ Weigh the fertilizer quantity in the hopper.
- ▶ Start your work.

### 5.2 Refilling

#### ■ *For weighing spreaders only*

Requirement:

- ✓ The kg level sensor function in the Machine settings menu is active.





If the menu item is not displayed in your machine control unit, please contact your dealer or customer service.

If the refill weight exceeds 400 kg, check the residual weight via the automatically displayed window.

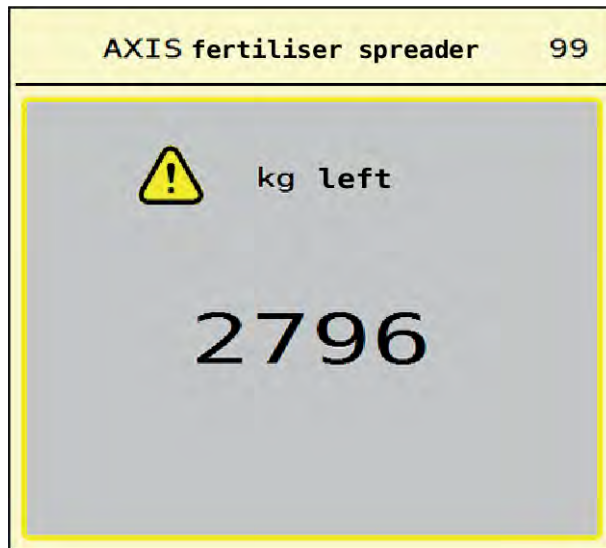

Fig. 36: Refill weight



- ▶ Press the ACK foil key prior to spreading.
- ▶ Continue spreading.



If a WiFi module is available, the app also shows the weight.

### 5.3 TELIMAT boundary spreading unit

- For *AXIS-M 20.2*, *AXIS-M 30.2*

#### ⚠ CAUTION!

##### **Risk of injury due to automatic adjustment of the TELIMAT unit!**

When the **boundary spreading key** is pressed, an electrical positioning cylinder automatically moves the machine to the boundary spreading position. This may cause injury and property damages.

- ▶ Before pressing the **boundary spreading key**, make sure that nobody is present in the hazard zone of the machine.



The TELIMAT option is preset for the control unit at the factory!

### TELIMAT with hydraulic remote control



The TELIMAT unit is hydraulically moved to its working or idle position. The TELIMAT unit can be activated or deactivated by pressing the border spreading key. Depending on the position, the display shows or hides the **TELIMAT icon**.

### TELIMAT with hydraulic remote control and TELIMAT sensors

If TELIMAT sensors are connected and activated, the **TELIMAT icon** is shown on the display when the TELIMAT border spreading unit is hydraulically moved into its operating position.

If the TELIMAT unit is moved back to the idle position, the **TELIMAT icon** is hidden again. The sensors monitor the TELIMAT adjustment and automatically activate or deactivate the TELIMAT unit. The limited border spreading key has no function with this option.

If the status of the TELIMAT unit cannot be detected for more than 5 seconds, alarm message 14 will be displayed; see 6.1 *Meaning of the alarm messages*.

## 5.4 Electrical TELIMAT unit

### ■ For AXIS-M 50.2

#### **CAUTION!**

##### **Risk of injury due to automatic adjustment of the TELIMAT unit!**

By pressing the **TELIMAT** key, the unit automatically moves to the boundary spreading position by means of an electrical actuating cylinder. This may cause injury and property damages.

- ▶ Before pressing the **TELIMAT** key, make sure that nobody is present in the hazard zone of the machine.

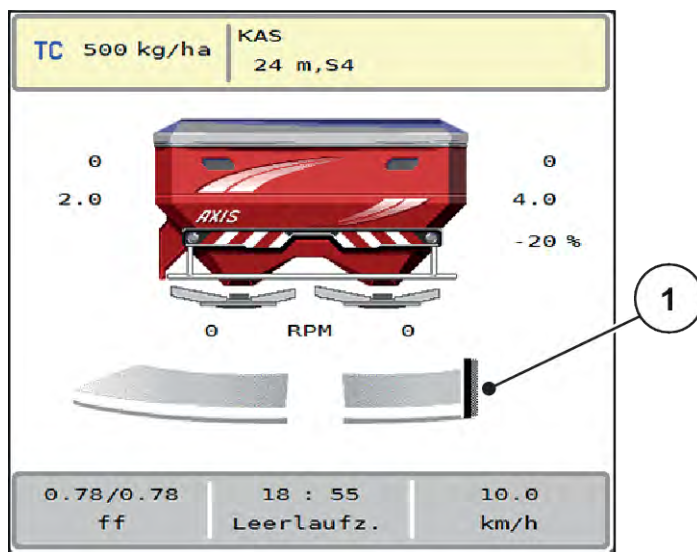

Fig. 37: Display TELIMAT

[1] Icon TELIMAT



By pressing the **TELIMAT** function key, the electrical TELIMAT unit moves to the limited border spreading position. During the adjustment, a **? symbol** appears on the display and then disappears once the working position is reached. Additional sensor monitoring of the TELIMAT position is not necessary since actuator monitoring is integrated.

In the event of blockages of the TELIMAT unit, alarm 23 appears; see Chapter 6.1 *Meaning of the alarm messages*.

## 5.5 Working with sections

### 5.5.1 Displaying the spreading type in the operating screen

The machine control unit offers 4 different spreading types for the spreading operation of the AXIS EMC machine. These settings can be configured directly in the working screen. During the spreading operation, you can switch between the spreading types in order to optimally adapt to the field requirements.

Button	Spreading type
	Activate section on both sides
	Section on the left, boundary spreading function on the right possible
	Section on the right, boundary spreading function on the left possible

Button	Spreading type
	<b>AXIS-H only</b> Boundary spreading function on both sides

- ▶ Press the function key several times until the desired spreading type is displayed.

### 5.5.2 Spreading with reduced sections: VariSpread V8

You can spread fertilizer to sections on one or both sides, to adapt the full spreading width to the field requirements. Every spreading side can be set continuously in the automatic mode and to a maximum of 4 steps in the manual mode.



- ▶ Press boundary spreading/sections toggle key.

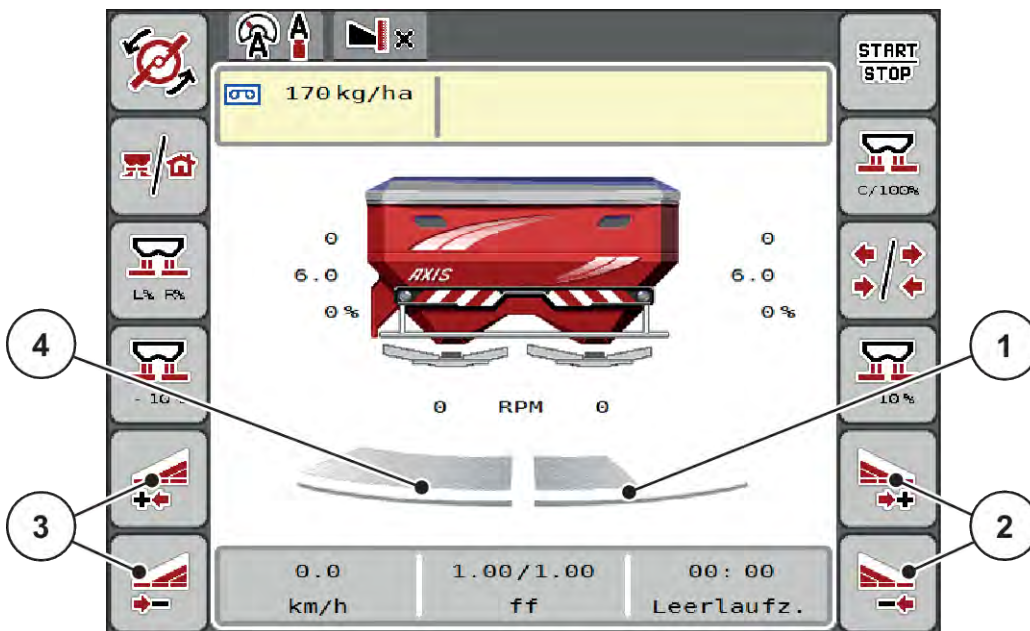

Fig. 38: Working screen: Sections with 4 levels

- [1] The right section is reduced to 2 steps.
- [2] Function keys for increasing or reducing spreading width on the right
- [3] Function keys for increasing or reducing spreading width on the left
- [4] The left spreading side spreads across the entire half.



- Each section can be reduced or increased in steps.

- ▶ Press the Reduce left spreading width or the Reduce right spreading width function key.  
*The section of the spreading side will be reduced by one step.*
- ▶ Press the Increase left spreading width function key or the Increase right spreading width function key.  
*The section of the spreading side will be increased by one step.*



The sections are **not** graded proportionally. The VariSpread spreading width assistant sets the spreading widths automatically.

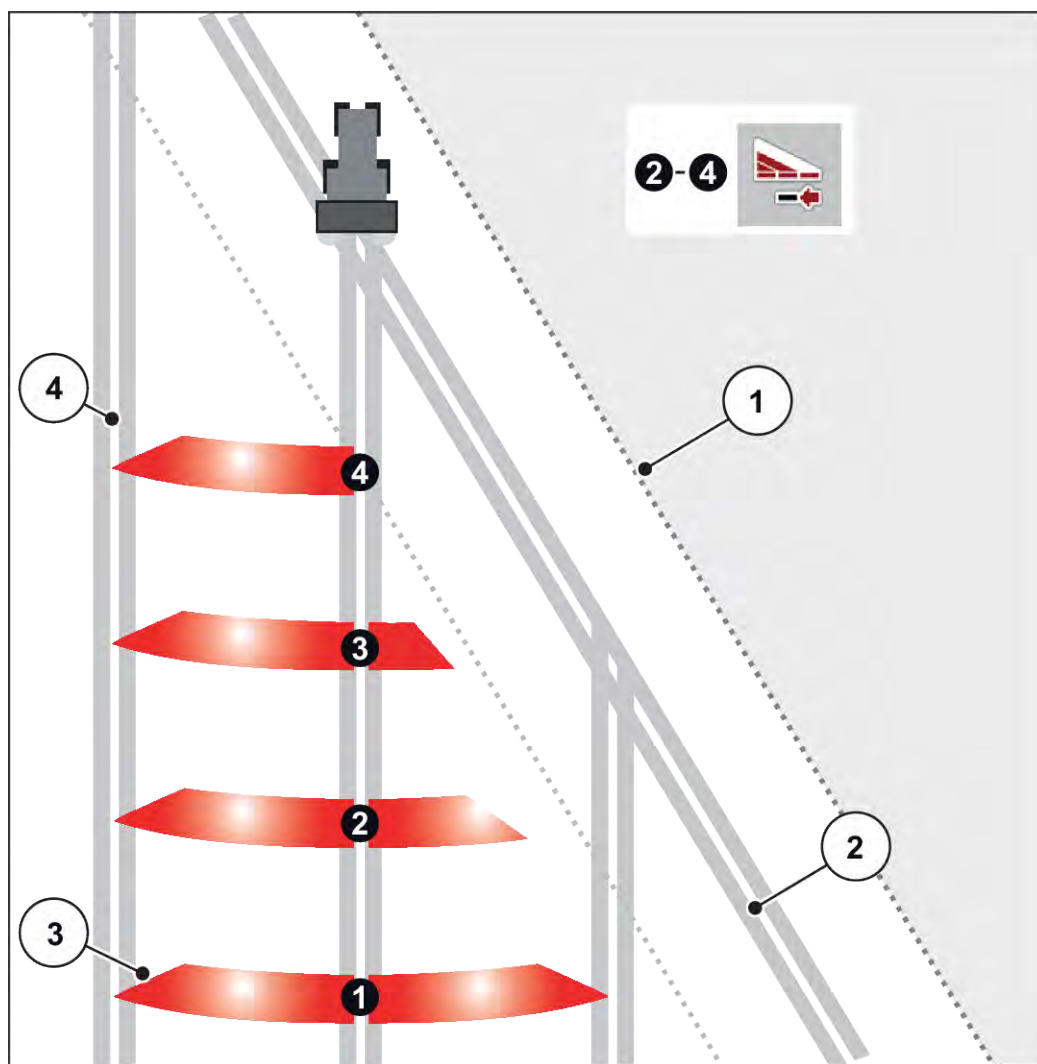

Fig. 39: Automatic section control

- [1] Field edge
- [2] Headlands tramline
- [3] Sections 1 to 4: Section reduction on the right hand side
- [4] Tramline in the field

### 5.5.3 Spreading with reduced sections: VariSpread pro

You can spread fertilizer to sections on one or both sides, to adapt the full spreading width to the field requirements. Every spreading side can be set continuously in automatic mode and in manual mode.



- ▶ Press boundary spreading/sections toggle key.

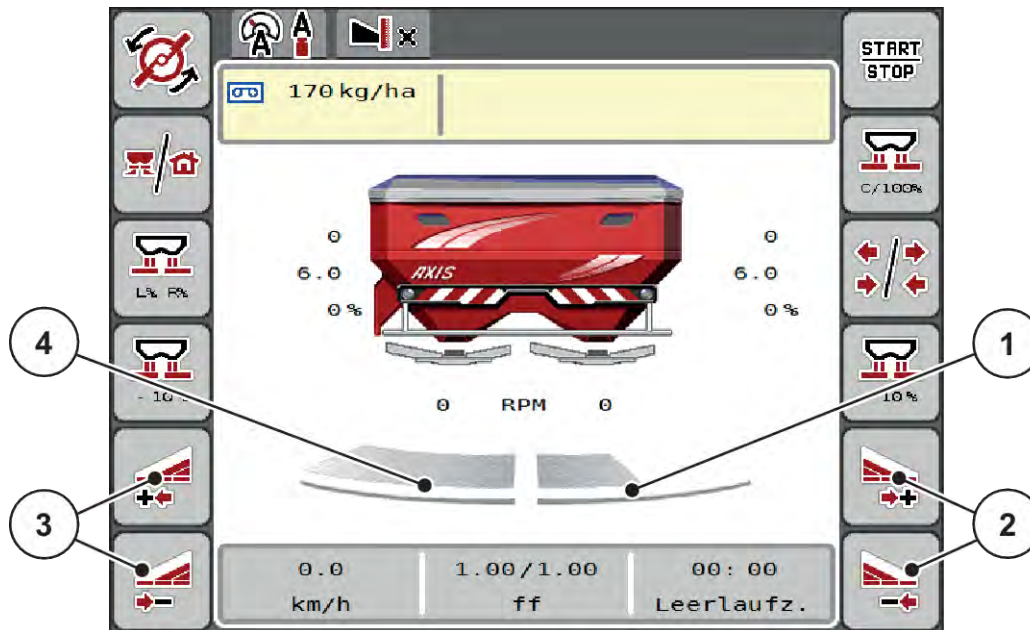

Fig. 40: Working screen: Continuous section control

- |   |  |
|---|--|
| [1] The right section is reduced to several steps.                        | [3] Function keys for increasing or reducing spreading width on the left |
| [2] Function keys for increasing or reducing spreading width on the right | [4] The left spreading side spreads across the entire half.              |



- Each section can be reduced or increased in steps.
- Section control is possible from the outside to the inside or vice versa. See Fig. 41 Automatic section control.

- ▶ Press the Reduce left spreading width or the Reduce right spreading width function key.  
*The section of the spreading side will be reduced by one step.*
- ▶ Press the Increase left spreading width function key or the Increase right spreading width function key.  
*The section of the spreading side will be increased by one step.*



The sections are **not** graded proportionally. The VariSpread spreading width assistant sets the spreading widths automatically.

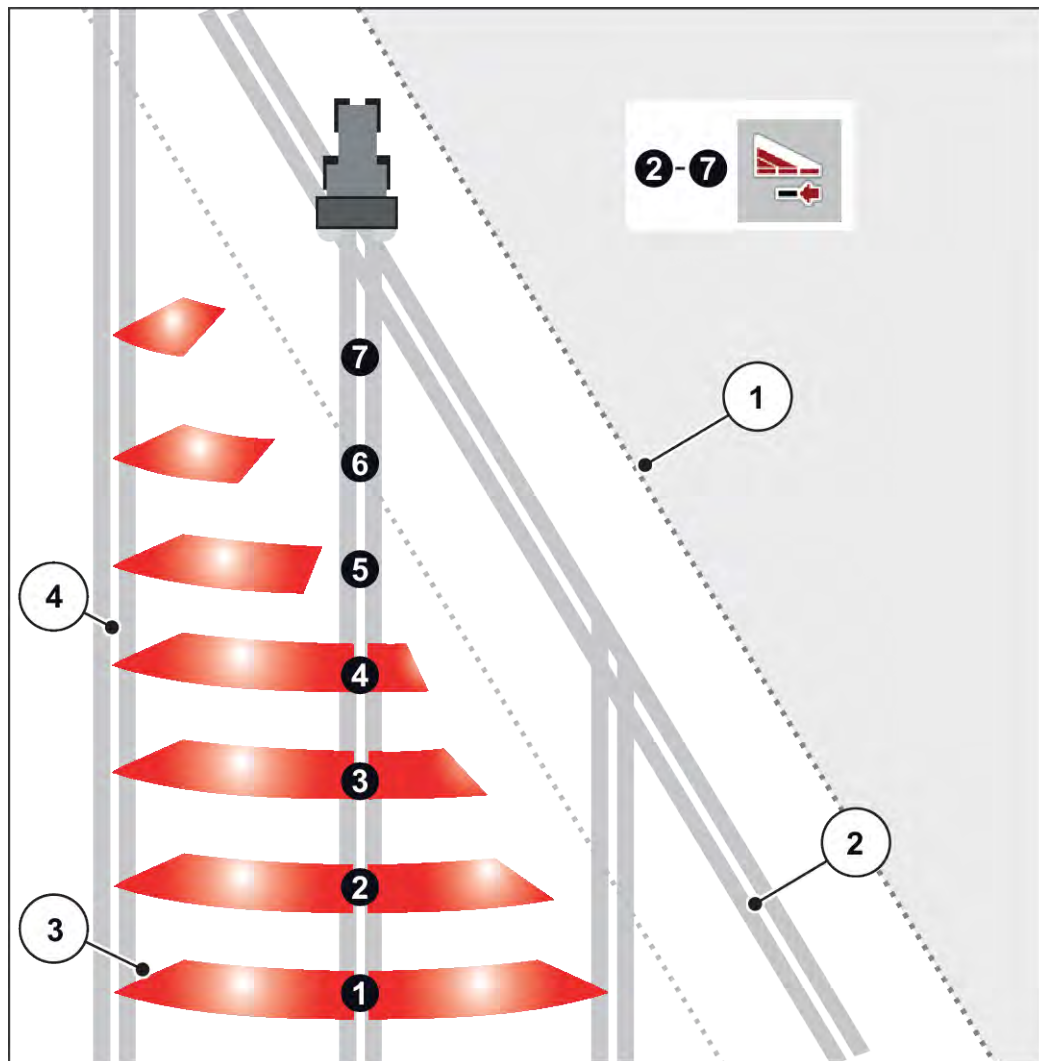

Fig. 41: Automatic section control

- [1] Field edge
- [2] Headlands tramline
- [3] Sections 1 to 4: Section reduction on the right hand side
- Sections 5 to 7: further section reductions
- [4] Tramline in the field

### 5.5.4 Spreading operation with one section and in boundary spreading mode

#### ■ VariSpread V8

During spreading operation, the sections can be changed gradually and boundary spreading can be deactivated. The figure below shows the operating screen with boundary spreading activated and a section activated.

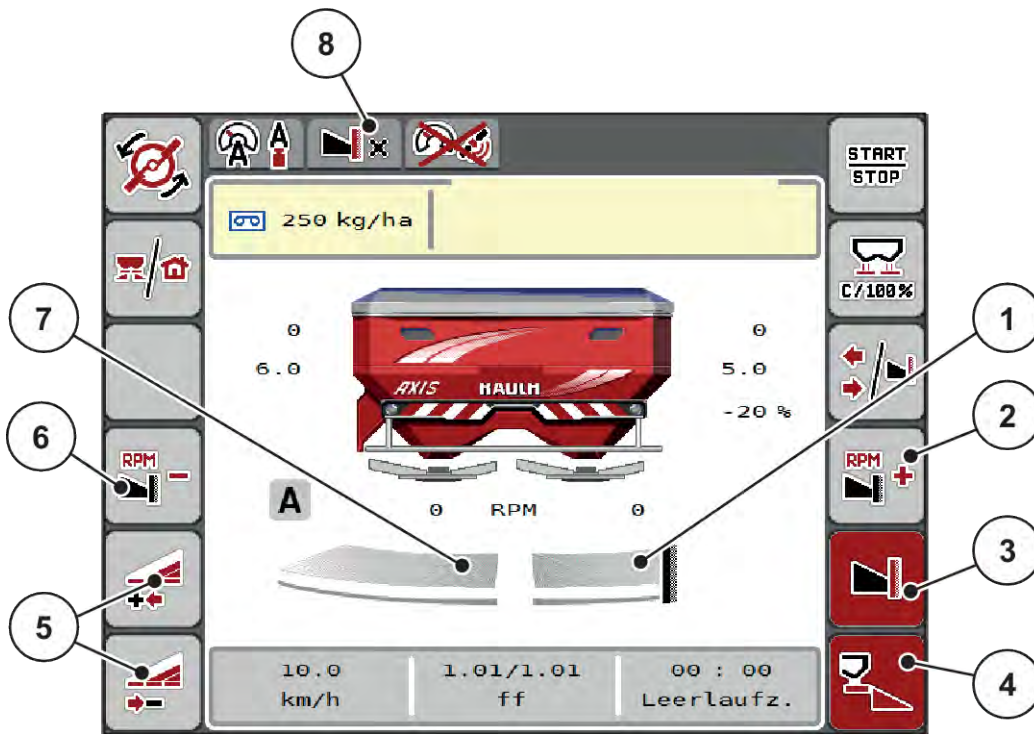

Fig. 42: Operating screen with one section on the left, boundary spreading on the right

- |  |  |
|--|--|
| [1] Spreading side on the right in the boundary spreading mode       | [5] Reduce or increase left section                                      |
| [2] Increase the spreading disc speed on the boundary spreading side | [6] Reduce the spreading disc speed on the limited border spreading side |
| [3] Boundary spreading mode is activated                             | [7] Left section adjustable in 4 steps                                   |
| [4] Right spreading side is activated                                | [8] The current boundary spreading mode is limited border.               |

- The application rate on the left is set to the full working width.
- The **Right boundary spreading** function key has been pressed, boundary spreading is active, and the application rate is reduced by 20%.
- Press the **Reduce left spreading width** function key in order to reduce the section.
- If you press the **C/100 %** function key, the full working width will be reapplied immediately.
- By pressing the Right boundary spreading function key, the boundary spreading function is deactivated.





The boundary spreading function is also possible in automatic mode with GPS Control. The boundary spreading side must be manually operated at all times.

- See 5.11 *GPS control*.

## 5.6 Spreading with the automatic operating mode (AUTO km/h + AUTO kg)



The AUTO km/h + AUTO kg operating mode allows for continuous regulation of the application rate during the spreading operation. The mass flow control is corrected at regular intervals on the basis of this information. This way, fertilizer metering can be optimized.



The AUTO km/h + AUTO kg operating mode is preselected as the standard factory default.

### Requirements for spreading:

- The AUTO km/h + AUTO kg operating mode is active (See 4.5.1 *AUTO/MAN mode*).
- The fertilizer settings are defined:
  - Application rate (kg/ha)
  - Working width (m)
  - Spreading disc
  - Normal disc speed (RPM)

- ▶ Fill the hopper with fertilizer.

### **WARNING!**

#### **Risk of injury caused by ejected fertilizer**

Ejected fertilizer may cause severe injury.

- ▶ Make sure nobody is present in the spreading zone of the machine before switching on the spreading discs.

### AXIS-M EMC only:



Start or stop the transmission **at low PTO speeds only**.



- ▶ **AXIS-H only:** Press **Spreading disc start**.
- ▶ Press the enter key to clear the alarm message. See 6.1 *Meaning of the alarm messages*.  
*The Idle measurement screen is displayed.*

*The Idle measurement starts automatically. See 5.7 Idle measurement.*



- ▶ Press Start/Stop  
*The spreading starts.*



We recommend displaying the flow factor in the working screen (refer to 2.2.2 *Display fields*), in order to monitor the mass flow control while spreading.



In case of any problems with flow factor control (clogging, ...), after troubleshooting at a standstill, switch to the Fertilizer settings menu and enter the flow factor 1.0.

### Resetting the flow factor

If the flow factor has fallen below the minimum value (0.4 and/or 0.2), alarm no. 47 and/or 48 appears. See 6.1 *Meaning of the alarm messages*.

## 5.7 Idle measurement

### 5.7.1 Automatic idle measurement

In order to achieve a high control accuracy, the EMC control must regularly measure and store the idling pressure.

The idle measurement for the determination of the idling pressure will start when the system is restarted.

It will also automatically start the idle measurement under the following conditions:

- The defined period since the last idle measurement has expired.
- You have made changes in the Fertilizer settings menu (RPM, type of spreading disc).

During the idle measurement, the following window appears.

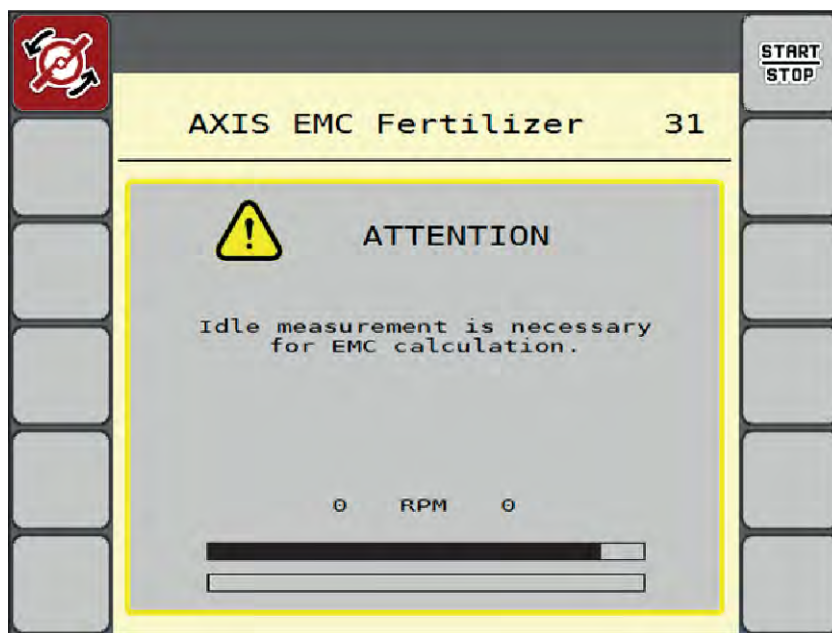

Fig. 43: Alarm display of idle measurement

When starting the spreading disc for the first time, the machine control adjusts the idling torque of the system. See 6.1 *Meaning of the alarm messages*.



If the alarm message is displayed repeatedly even though the transmission oil is warm:

- Compare the installed spreading disc with the type entered in the Fertiliser settings menu. If required, adjust the type.
- Check the spreading disc for tight seat. Re-tighten the wheel nut
- Check the spreading disc for damage. Replace the spreading disc.

Once the idle measurement has been completed, the machine control unit will set the idling time to 19:59 minutes in the display of the working screen.



- ▶ Press **Start/Stop**.

*The spreading starts.*

*The idle measurement runs in the background, even if the metering slides are closed. However, no screen is shown on the display. However, no screen is shown on the display.*

Once this idling time has expired, a further idle measurement is started automatically.

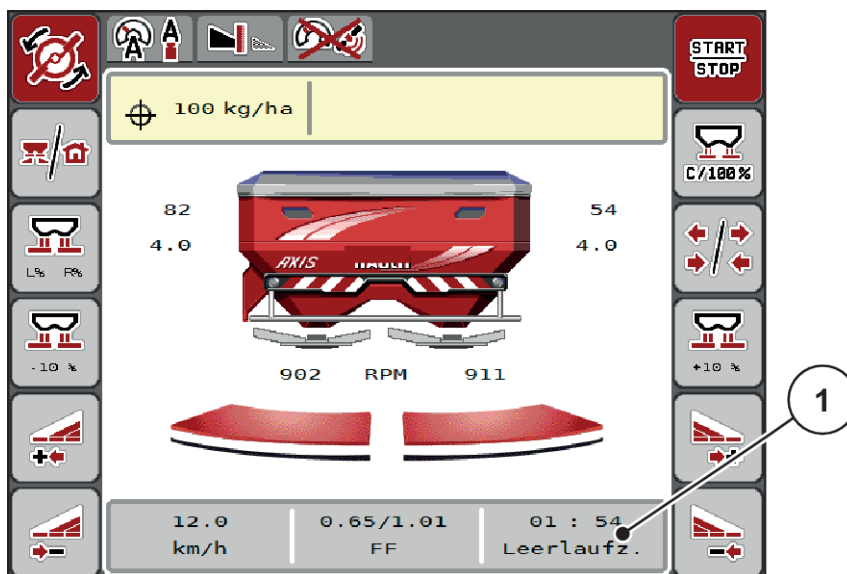

Fig. 44: Display of the idle measurement in the working screen

[1] Time until the next idle measurement



In the case of a reduced spreading disc speed, no idle measurement can be executed if boundary spreading or section reduction are activated!



When the metering slides are closed, an idle measurement is always carried out in the background (without alarm message)!



Do not reduce the engine speed during the idle measurement in the headlands!  
The tractor and hydraulics circuit must have reached their operating temperature!

### 5.7.2 Manual idle measurement

In the case of unusual changes in the flow factor, start the idle measurement manually.



► In the Main menu, press the idle measurement key.

*The idle measurement is started manually.*

### 5.8 Spreading with the AUTO km/h operating mode



This working mode is applied by default for machines that lack a weighing system.



In this working mode, the application rate can be reduced down to 1 kg/ha.

**Requirements for spreading:**

- AUTO km/h working mode is active (see 4.5.1 AUTO/MAN mode).
- The fertilizer settings are defined:
  - Application rate (kg/ha),
  - Working width (m)
  - Spreading disc
  - Normal disc speed (RPM)

- ▶ Fill the hopper with fertilizer.



In order to achieve an optimum spreading result in the AUTO km/h working mode, a calibration should be carried out before starting spreading.

- ▶ Carry out a calibration to determine the flow factor or obtain the flow factor from the fertilizer chart and enter the flow factor manually.

**! WARNING!**

**Risk of injury caused by ejected fertilizer**

Ejected fertilizer may cause severe injury.

- ▶ Make sure nobody is present in the spreading zone of the machine before switching on the spreading discs.



- ▶ **AXIS-H only:** Press **Spreading disc start**.



- ▶ Press Start/Stop.

*The spreading starts.*

## 5.9

### Spreading with the MAN km/h operating mode



If there is no speed signal, the MAN km/h operating mode is active.

- ▶ Access the menu Machine settings > AUTO/MAN mode.
- ▶ Select the MAN km/h menu item.  
*The display shows the input window Forward speed.*
- ▶ Enter the value for the forward speed during spreading.
- ▶ Press OK.
- ▶ Configure the fertilizer settings:
  - ▷ Application rate (kg/ha)
  - ▷ Working width (m)
- ▶ Fill the hopper with fertilizer.



In order to achieve an optimum spreading result in the MAN km/h operating mode, a calibration is to be carried out before starting the spreading.

- ▶ Carry out a calibration to determine the flow factor or obtain the flow factor from the fertilizer chart and enter the flow factor manually.



- ▶ **AXIS-H only:** Press **Spreading disc start**.



- ▶ Press Start/Stop

*The spreading starts.*



Always observe the set forward speed during spreading.

### 5.10 Spreading in the MAN scale operating mode



With the MAN scale operating mode, you can manually adjust the metering slide opening during the spreading operation.

The manual mode is only applied:

- If there is no speed signal (radar or wheel sensor not available or defective)
- when spreading slug pellets or fine seeds

The MAN scale operating mode is appropriate for slug pellets and fine seeds since the automatic mass flow control cannot be activated due to the low weight reduction.



For uniform spreading of the spreading material, a constant forward speed must be applied in manual operating mode.

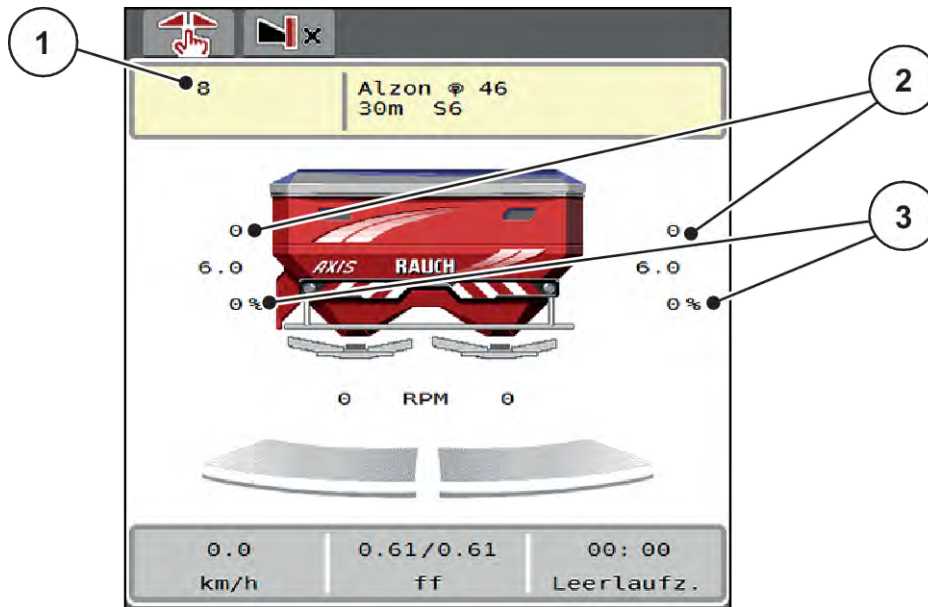

Fig. 45: MAN scale operating screen

- [1] Display of metering slide target value scale position      [3] Application rate adjustment
- [2] Display of current metering slide scale position

- ▶ Access the menu Machine settings > AUTO/MAN mode.
- ▶ Select the MAN scale menu item.  
*The Position of dosing slider opening window is displayed.*
- ▶ Enter the scale value for the dosing slider opening.
- ▶ Press OK.
- ▶ Switch to the working screen.
- ▶ **AXIS-H only: Press Spreading disc start.**
- ▶ Press Start/Stop.  
*The spreading starts.*





► To change the metering slide opening, press the MAN+ or MAN- function key.

- ▷ L% R% for selecting the side of the metering slide opening
- ▷ MAN+ to increase the dosing slider opening or
- ▷ MAN- to reduce the dosing slider opening.



In order to achieve an optimum spreading result in manual mode as well, we recommend using the metering slide opening and forward speed values provided in the fertilizer chart.

### 5.11 GPS control



The machine control unit can be combined with an ISOBUS terminal with SectionControl. Various data is exchanged between both devices to automate control.

The ISOBUS terminal with SectionControl communicates the specifications for the opening and closing of dosing sliders to the machine control unit.

The **A** symbol next to the spreading wedges indicates that the automatic function is enabled. The ISOBUS terminal with SectionControl opens and closes the individual sections depending on the respective position in the field. The spreading starts only after when you press **Start/Stop**.

#### **WARNING!**

##### **Risk of injury due to discharged fertilizer**

The SectionControl function automatically starts the spreading operation without warning.

Ejected fertilizer can harm the eyes and nasal mucous membranes.

There is also a risk of slipping.

- Ensure that nobody is present in the hazard zone during the spreading operation.

During spreading, **one or several sections** can be closed at any time. If the sections are activated for automatic operation again, the last state requested is restored.

If the ISOBUS terminal with SectionControl is changed from automatic to manual mode, the machine control unit closes the metering slides.



For the use of the **GPS control** functions of the machine control unit, the GPS-Control setting in the Machine settings menu must be activated!



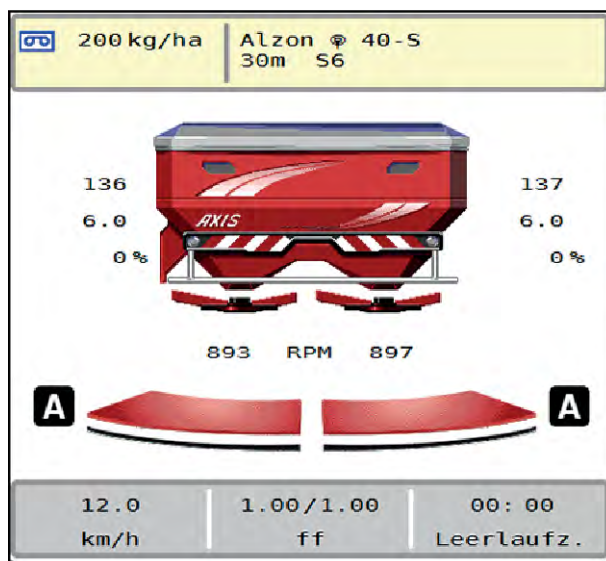

Fig. 46: Spreading operation display in the operating screen with GPS Control

The **OptiPoint** function calculates the optimal turn on and turn off position for spreading in the headlands based on the settings in the machine control unit; refer to 4.4.10 Calculate OptiPoint.



To ensure correct configuration of the OptiPoint function, enter the correct aerodynamic factor for the fertilizer being used. The aerodynamic factor can be obtained from the fertilizer chart for your machine.

See 4.4.10 Calculate OptiPoint.

#### ■ Turn on distance (m)

The Turn on dist. (m) parameter refers to the switch-on distance [A] measured from the field border [C]. At this position in the field, the metering slides open. This distance depends on the type of fertilizer and represents the ideal switch-on distance for optimized fertilizer distribution.

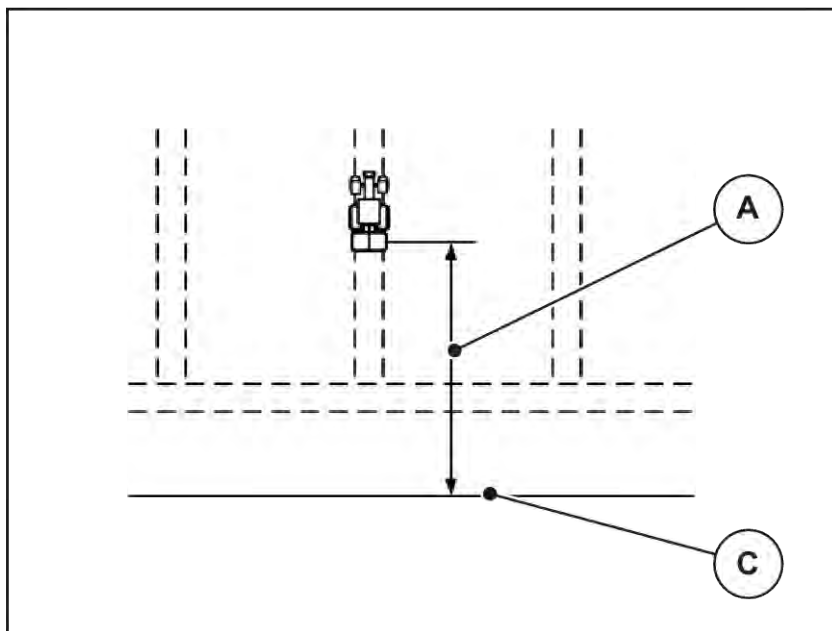

Fig. 47: Distance on (measured from field border)

[A] Turn on distance

[C] Field border

If you want to change the switch-on position in the field, you need to adjust the Turn on dist. (m) value.

- A lower value for this distance means that the switch-on position is closer to the field border.
- A greater value means that the switch-on position is closer to the center of the field.

■ **Turn off distance (m)**

The Turn off dist. (m) parameter refers to the turn off distance [B] measured from the field border [C]. At this position in the field, the metering slides start to close.

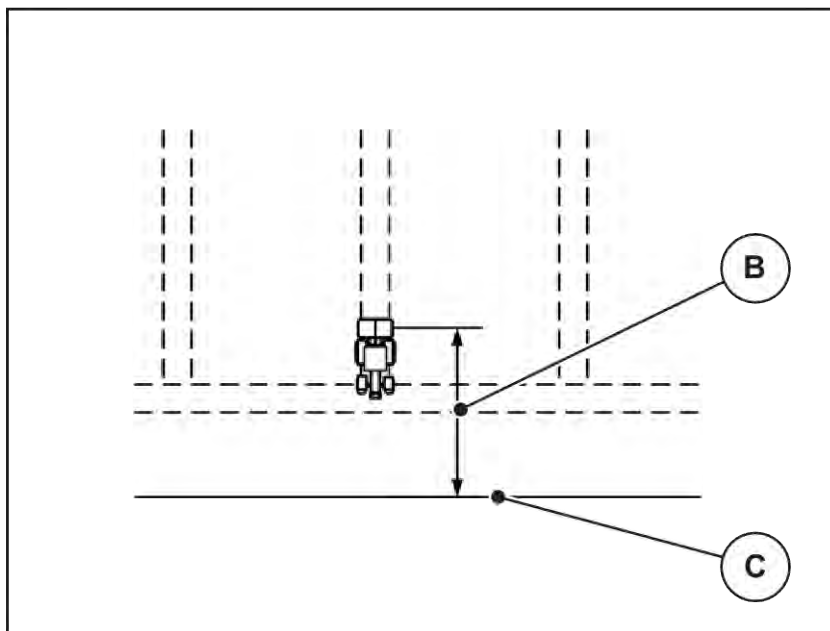

Fig. 48: Distance off (measured from field border)

[B] Turn off distance

[C] Field border

If you want to change the switch-off position, you need to adjust the Turn off dist. (m) accordingly.

- A lower value means that the switch-off position is closer to the field border.
- A greater value means that the switch-off position is closer to the center of the field.

If you want to turn through the headland track, enter a greater distance in Turn off dist. (m). Here, the adjustment must be as low as possible so that the metering slides close as soon as the tractor enters the headland track. An adjustment of the switch-off distance may lead to insufficient fertilization around the switch-off positions in the field.

## 6 Alarm messages and possible causes

### 6.1 Meaning of the alarm messages

Various alarm messages can be displayed on the ISOBUS terminal display.

No.	Message in display	Meaning and possible cause
1	Fault in dosing system, stop !	The motor of the metering system cannot reach the specified target value: <ul style="list-style-type: none"> <li>• Blockage</li> <li>• No position feedback</li> </ul>
2	Max. outlet reached! Speed or application rate too high	Metering slide alarm <ul style="list-style-type: none"> <li>• The maximum metering opening is reached.</li> <li>• The set application rate (+/- quantity) exceeds the maximum metering opening.</li> </ul>
3	Flow factor is outside limits	The flow factor must lie within a range between 0.40 and 1.90. <ul style="list-style-type: none"> <li>• The newly calculated or entered flow factor is outside this range</li> </ul>
4	Hopper left empty!	The filling level sensor on the left reports "empty." <ul style="list-style-type: none"> <li>• The left hopper is empty.</li> </ul>
5	Hopper right empty!	The filling level sensor on the right reports "empty." <ul style="list-style-type: none"> <li>• The right hopper is empty.</li> </ul>
14	Error by setting TELIMAT	Alarm for the TELIMAT sensor This error message is displayed if the TELIMAT status is not detected for more than 5 seconds.
15	Memory full, Delete one private fertiliser chart	A maximum of 30 fertilizer types are stored in the memory for the fertilizer charts.
16	Approach drop point Yes = Start	Safety request before the drop point is automatically approached <ul style="list-style-type: none"> <li>• Drop point setting in the menu Fertiliser settings</li> <li>• Fast emptying</li> </ul>

No.	Message in display	Meaning and possible cause
17	Error by setting drop point	<p>The drop point adjustment cannot reach the specified target value.</p> <ul style="list-style-type: none"> <li>• Fault, for instance with the power supply</li> <li>• No position feedback</li> </ul>
18	Error by setting drop point	<p>The drop point adjustment cannot reach the specified target value.</p> <ul style="list-style-type: none"> <li>• Blockage</li> <li>• No position feedback</li> <li>• Calibration test</li> </ul>
19	Defect by setting drop point	<p>The drop point adjustment cannot reach the specified target value.</p> <ul style="list-style-type: none"> <li>• No position feedback</li> </ul>
20	Error at LIN bus participant:	<p>Communication problem</p> <ul style="list-style-type: none"> <li>• Defective cable</li> <li>• Loose plug connector</li> </ul>
21	Spreader overloaded!	<p>For weighing spreaders only: The fertilizer spreader is overloaded.</p> <ul style="list-style-type: none"> <li>• Too much fertilizer in the hopper</li> </ul>
22	Unknown condition Function-Stop	<p>Communication problem with terminal</p> <ul style="list-style-type: none"> <li>• Possible software error</li> </ul>
23	Error by setting TELIMAT	<p>The TELIMAT adjustment cannot reach the specified target value.</p> <ul style="list-style-type: none"> <li>• Blockage</li> <li>• No position feedback</li> </ul>
24	Defect by setting TELIMAT	Defective TELIMAT actuator
25	Activate disc start. Confirm with ENTER	
26	Discs started up without activation	Defective or manually switched hydraulics valve
27	Discs started up without activation	Defective or manually switched hydraulics valve
28	Disc could not start up properly. Deactivate disc start.	<p>Spreading discs do not rotate.</p> <ul style="list-style-type: none"> <li>• Blockage</li> <li>• No position feedback</li> </ul>

No.	Message in display	Meaning and possible cause
29	The agitator motor is overloaded.	The agitator is blocked. <ul style="list-style-type: none"> <li>• Blockage</li> <li>• Defective connection</li> </ul>
30	The discs shall be activated before opening the metering sliders.	Correct software operation <ul style="list-style-type: none"> <li>• Start spreading discs</li> <li>• Open metering slides</li> </ul>
31	Idle measurement is necessary for EMC calculation.	Alarm message before the idle measurement <ul style="list-style-type: none"> <li>• Activate spreading disc start.</li> </ul>
32	Externally controlled parts can be moved. Risk of injury through squeezing and shearing! - Direct ALL persons out of the danger zone - Read the instruction manual Confirm with ENTER	If the machine control unit is activated, components may move unexpectedly. <ul style="list-style-type: none"> <li>• Follow the displayed instructions only if all risks have been eliminated.</li> </ul>
33	Stop the discs and close the metering sliders	You may only switch to the System / Test menu area if the spreading operation has been deactivated. <ul style="list-style-type: none"> <li>• Stop spreading discs.</li> <li>• Close the metering slide.</li> </ul>
45	Error at M-EMC sensors. EMC control deactivated!	The sensor has stopped sending signals. <ul style="list-style-type: none"> <li>• Cable breakage</li> <li>• Defective sensor</li> </ul>
46	Spreading speed error. Observe spreading speed of 450..650 rpm!	The PTO speed is outside the range for the M EMC function.
47	Left dosing error, hopper empty, outflow blocked!	<ul style="list-style-type: none"> <li>• Hopper empty</li> <li>• Outlet blocked</li> </ul>
48	Right dosing error, hopper empty, outflow blocked!	<ul style="list-style-type: none"> <li>• Hopper empty</li> <li>• Outlet blocked</li> </ul>
49	Idle meas. implausible. EMC control deactivated!	<ul style="list-style-type: none"> <li>• Defective sensor</li> <li>• Defective transmission</li> </ul>
50	Idle meas. impossible. EMC control deactivated!	PTO speed not permanently stable

No.	Message in display	Meaning and possible cause
52	Error at hopper cover	<p>The position of the hopper cover could not be reached.</p> <ul style="list-style-type: none"> <li>• Blockage</li> <li>• Defective actuator</li> </ul>
53	Defect at hopper cover	<p>The hopper cover actuator cannot reach the target value for the movement.</p> <ul style="list-style-type: none"> <li>• Blockage</li> <li>• Defective actuator</li> </ul>
57	Error at hopper cover	<p>The hopper cover actuator cannot reach the target value for the movement.</p> <ul style="list-style-type: none"> <li>• Blockage</li> <li>• No position feedback</li> </ul>
71	Impossible to reach disc speed	<p>The spreading disc speed is not within the 5 % target range.</p> <ul style="list-style-type: none"> <li>• Problem with oil supply</li> <li>• Proportional valve spring is jammed.</li> </ul>
72	Error at SpreadLight	<p>Power supply is too high; the operating lights will be switched off.</p>
73	Error at SpreadLight	<p>Overload</p>
74	Defect at SpreadLight	<p>Connection error</p> <ul style="list-style-type: none"> <li>• Defective cable</li> <li>• Loose plug connector</li> </ul>
82	Type of machine modified. Spreading error possible. New configuration required!	<p>The operating modes cannot be combined with certain machine types</p> <ul style="list-style-type: none"> <li>▶ Restart the machine control unit when changing machine type.</li> <li>▶ Implement machine settings.</li> <li>▶ Load fertilizer chart for the machine type.</li> </ul>
88	Error at disc speed sensor	<p>The spreading disc RPM could not be determined</p> <ul style="list-style-type: none"> <li>• Cable breakage</li> <li>• Defective sensor</li> </ul>

No.	Message in display	Meaning and possible cause
89	Disc speed too high	Alarm of the spreading disc sensor <ul style="list-style-type: none"> <li>The maximum RPM is reached.</li> <li>The set RPM exceeds the maximum admissible value.</li> </ul>
90	AXMAT-Stop	The AXMAT function is automatically deactivated and no longer regulates. <ul style="list-style-type: none"> <li>More than 2 sensors are reporting an error.</li> <li>Communication error</li> </ul>
93	This disc type requires a modification on the TELIMAT device. Please follow the mounting instructions!	Spreading disc S1 is installed and the machine is equipped with TELIMAT. Spreading errors possible during border spreading <ul style="list-style-type: none"> <li>This spreading disc type requires conversion of the TELIMAT device.</li> </ul>

## 6.2 Fault/alarm

An alarm message is displayed with a red frame and with a warning symbol.

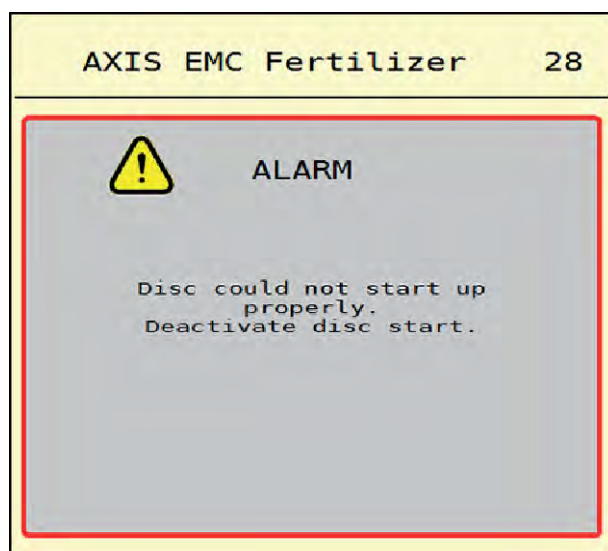

Fig. 49: Alarm message (example)



## 6.2.1 Acknowledging an alarm message

### Acknowledging an alarm message:

- ▶ Rectify the cause of the alarm message.

Observe the operating manual for the mineral fertilizer spreader. See also *6.1 Meaning of the alarm messages*.

- ▶ ACK Press



In the case of different ISOBUS terminals, acknowledging the alarm messages may differ.

You can use various keys to acknowledge other messages with a yellow frame:

- Enter
- Start/Stop

For this purpose, follow the instructions on screen.

## 7 Special equipment

Illustration	Designation
 A black cable with a red connector at one end and a black connector at the other, coiled on a light background.	Level sensor
 A black joystick with a grey top panel. The top panel has several buttons with icons and text, including 'STRICT STOP' and 'C/STOP'. It has a threaded base.	CCI A3 joystick
 A black rectangular module with a cable attached to one end and a metal mounting bracket on the other.	WiFi module

## 8 Guarantee and warranty

RAUCH devices are manufactured using modern production methods and with the greatest of professional care, and are subjected to numerous inspections.

This is why RAUCH is offering a 12 month warranty if the following conditions are met:

- The warranty starts on the date of purchase.
- The warranty covers material or manufacturing defects. We are liable for third-party products (hydraulics, electronics) only to the extent of the relevant manufacturer. During the warranty period, manufacturing and material defects will be rectified free of charge with the replacement or repair of the affected parts. Other rights extending beyond the above, such as claims for conversion, reduction, or replacement for reasons of damage not suffered by the supplied product are explicitly excluded. Warranty services are provided by authorized workshops, by RAUCH factory representatives or the factory itself.
- Consequences of natural wear, dirt, corrosion, and all defects caused by improper use as well as external influences shall be excluded from the warranty. Any unauthorized repairs or changes to the original condition will void the warranty. The warranty is voided if any spare parts other than genuine RAUCH spare parts were used. Therefore, the directions in the operating manual must be observed. Please contact our company representatives of the parent company if you have any questions or doubts. Warranty claims must be submitted to the company within 30 days at the latest after the damage has occurred. The date of purchase and the machine number must be indicated. If repairs under the warranty are required, they must be carried out by the authorized workshop only after consultation with RAUCH or the company's appointed representatives. The warranty period will not be extended by warranty work. Transport damage is not a factory defect and is therefore not covered by the manufacturer's warranty manufacturer.
- Claims for damage other than to the RAUCH devices will not be accepted. This also means that no liability will be accepted for damage resulting from spreading errors. Unauthorized modifications of the RAUCH devices may result in consequential damage, for which the manufacturer will not accept any liability. The manufacturer's exclusion from liability will not apply in the case of willful intent or gross negligence by the owner or a senior employee, and in cases where – according to the product liability law – there is liability for personal injury or material damage to privately used objects in the event of defects in the supplied product. The exclusion from liability will also not apply if characteristics are missing that are explicitly guaranteed, if the purpose of their guarantee was to protect the purchaser against damage not suffered by the supplied product itself.

**RAUCH Streutabellen**  
**RAUCH Fertilizer Chart**  
**Tableaux d'épandage RAUCH**  
**Tabele wysiewu RAUCH**  
**RAUCH Strooitabellen**  
**RAUCH Tabella di spargimento**  
**RAUCH Spredetabellen**  
**RAUCH Levitystaulukot**  
**RAUCH Spridningstabellen**  
**RAUCH Tablas de abonado**



<https://streutabellen.rauch.de/>



**RAUCH Landmaschinenfabrik GmbH**

Victoria Boulevard E 200  
77836 Rheinmünster · Germany



info@rauch.de · www.rauch.de

Phone +49 (0) 7229/8580-0