

# RAUCH

## OPERATORS MANUAL

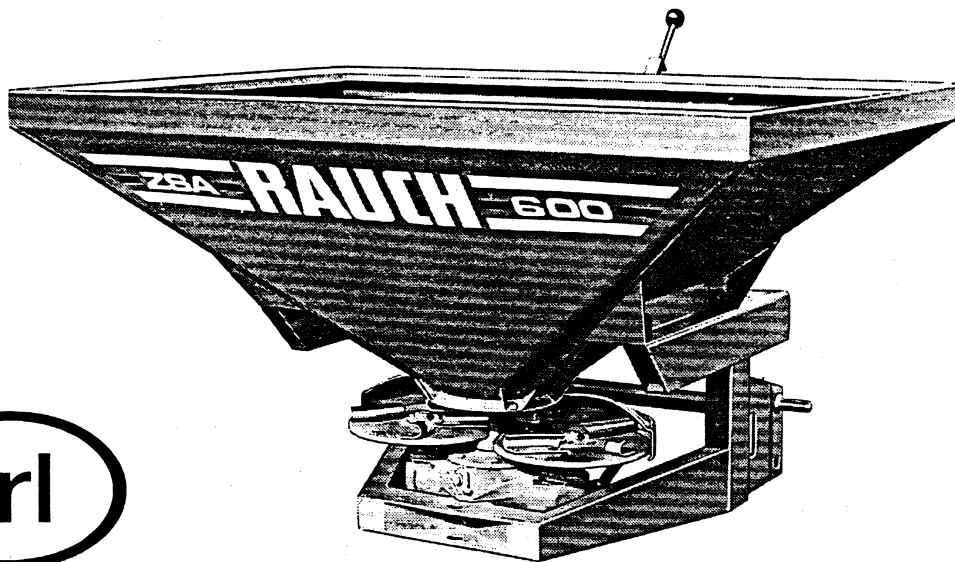

## FERTILISER SPREADER

# ZSA

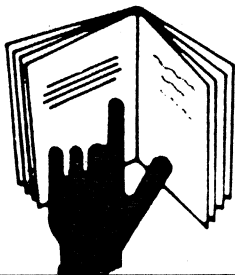

PLEASE READ CAREFULLY  
BEFORE USING THE MACHINE

ZSA-B-1190-Irl

# RAUCH

Landmaschinenfabrik GmbH

D-76547 Sinzheim  
Telex 78 12 42

▪ Telefon 07221/985-0  
▪ Telefax 07221/985 200

## TABLE OF CONTENTS

	<u>Page</u>
A note to you Mr. Owner	1
Caution! Think safety!	2/3
Safety decals on the fertiliser spreader ZSA	4
<b>1. Technical data</b>	<b>5</b>
1.1 Technical details of the ZSA-range	5
1.2 Scope of fertilisers	
<b>2. Recommendations regarding new machines</b>	<b>5</b>
2.1 Inspection	5
2.2 Standard equipment	6
2.3 Optional equipment	
<b>3. Operating instructions</b>	<b>6</b>
3.1 P.T.O.-shaft	6/7
3.2 Attachment to the 3-point-linkage	8
3.3 Hydraulic remote controls	9
3.4 Adjustment of quantity application	9/10
3.5 Control of spreading quantity with calibration kit	11/12
3.6 Late top dressing	13
3.7 One side spreading, headland spreading	13
<b>4. Maintenance</b>	<b>14</b>
<b>5. Additional advices</b>	<b>15/16</b>
<b>6. Important recommendations for accurate spreading</b>	<b>16</b>

## A NOTE TO YOU, MR. OWNER

In buying a RAUCH fertiliser spreader you have chosen wisely. You have purchased a dependable machine, but only by proper care and operation can you expect to receive the performance and long service built into it.

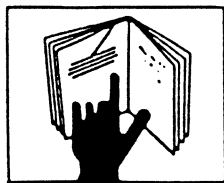

**PLEASE READ AND UNDERSTAND OPERATING INSTRUCTIONS CAREFULLY BEFORE STARTING TO SPREAD.**

This manual contains all necessary information for you to receive full efficiency from your spreader. The performance you get from this machine is largely dependent upon how well you read and understand this manual and apply this knowledge. The spreader is a simple machine, but a machine in which causes for troubles are often overlooked even though apparent. These troubles are normally shown in poor work, though they are largely due to natural wear or parts not being in original adjustment condition. Therefore, please **DO NOT ASSUME THAT YOU KNOW HOW TO OPERATE AND MAINTAIN YOUR SPREADER** before reading this manual carefully. **KEEP THIS MANUAL AVAILABLE FOR READY REFERENCE.**

**Any damage of the spreader caused by handling mistakes or improper usage is not covered by warranty.**

Your RAUCH dealer will instruct you in the general operation of your machine. He is interested in you getting the best performance possible, and his staff will be glad to answer any special questions that may arise regarding the operation of the RAUCH fertiliser spreader.

Your RAUCH dealer can supply genuine RAUCH service parts. These parts are manufactured and carefully inspected in the same factory that builds the fertiliser spreader to assure high quality and accurate fitting of any necessary replacements.

**TYPE:**

**MACHINE-NUMBER:**

Mark down here type and number of your spreader, as it is marked on the sticker attached to the frame. When ordering spare-parts or additional equipment, please refer to these numbers.

### IMPROVEMENTS

RAUCH is continually striving to improve its products and, therefore, reserves the right to make improvements or changes, when it becomes practical to do so, without incurring any obligations to make changes, or additions, to the equipment sold previously.

If you have further questions, do not hesitate to contact us.

Yours faithfully,

**R A U C H**  
Landmaschinenfabrik GmbH

### INSPECTION

**Damaged or missing parts have to be certified immediately by the carrier. In case of doubt get in contact with the representative of RAUCH.**



**ATTENTION:**

THIS SYMBOL IS USED ALL THROUGH THIS MANUAL EVERY TIME YOUR PERSONAL SAFETY, THE SAFETY OF ANOTHER PERSON OR THE GOOD OPERATION OF YOUR MACHINE ARE AT A RISK. THEREFORE TAKE SPECIAL NOTE OF ALL SAFETY SIGNS.



**CAUTION!  
THINK SAFETY!**



Most accidents which occur during work, maintenance or transport are the result of not observing all elementary safety procedures. For this reason it is most important that all persons likely to work and maintain this machine, whether it is yourself, a member of your family or an employee, must respect very carefully all elementary procedures listed hereafter. In addition, all safety advice given by decals on the machine must be given the same attention.

1. Besides the safety advices in this operators manual also respect the general safety and accident prevention rules.
2. The safety decals give important advice safe work with the machine. To follow them serves to your personal safety.
3. Each time before using the machine, verify that all fixing devices (nuts, bolts etc). are sufficiently tightened.
4. Before starting to work acquaint yourself with the operation elements and their function. During work it will be too late.
5. Before each use check, if fertiliser spreader and tractor conform to the traffic rules and to the accident prevention rules.
6. Fill the fertiliser only with tractor shut-off, ignition key pulled out and closed shut-off slides.
7. Before carrying out adjustments, greasing or cleaning turn-off the tractor P.T.O.- drive shaft and pull out the ignition key. Wait for all moving parts to completely stop.
8. Keep hand, feet and clothing away from moving parts.
9. Do not lay down any foreign objects in the hopper.
10. The operator must make absolutely sure that no person or animal is in the projection zone of the machine before starting it and during its operation.
11. Take special care that all prevention devices and P.T.O.-guards are always in place and are prevented from rotating using the safety chains provided for this purpose.

**ATTENTION!**

**ROTATING ELEMENTS!**

**DANGER DUE TO PROJECTION OF FERTILISER PARTICLES!  
KEEP ALL PERSONS AWAY FROM THE DANGER AREA!**

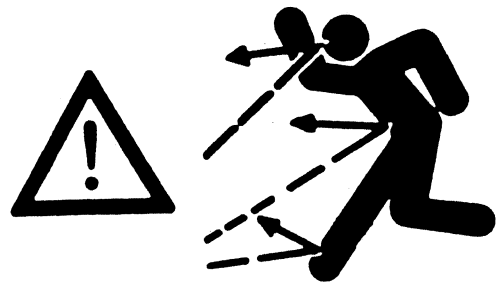

12. Do not permit anyone to ride on the machine. Never carry other persons on the machine when working or in transport.

13. Make certain, that the spreader cannot be turned on accidentally by other persons when carrying out controls or repairs.
14. Before driving in a public area, the driver must ensure that the machine is equipped with guards and safety indicators conforming to the highway code.
15. Before leaving the machine lower the spreader to the ground, turn-off engine and pull out the ignition key.
16. Never stand between machine and tractor without having secured the tractor against rolling.
17. Do not load the machine beyond the capacity of the tractor or its tyre equipment. The maximum payload for ZSA 450: 600 kg / ZSA 600 + 800: 1200 kg. In the calibration chart you will find the specific weight for each fertiliser.
18. Never allow the machine to run unattended.
19. It is most important to have your machine checked by your dealer after each season, especially the discs and blades as well as their fixing devices (nuts, bolts, etc.).
20. When the fertiliser spreader is damaged turn it immediately off. Pull out ignition key and repair the machine.
21. Put drive shaft immediately right, when it becomes damaged.
- 22.



## CAUTION

AGRICULTURAL CHEMICALS CAN BE DANGEROUS. IMPROPER SELECTION OR USE CAN SERIOUSLY INJURE PERSONS, ANIMALS, PLANTS, SOIL OR OTHER PROPERTY. BE SAFE: SELECT THE RIGHT CHEMICAL FOR THE JOB. HANDLE IT WITH CARE. FOLLOW THE INSTRUCTIONS ON THE CONTAINER LABEL AND OF THE EQUIPMENT MANUFACTURER.



The manufacturer cannot be held responsible if the machine is not operated and handled in accordance with the instructions given in the Assembly/Operators manual.

The user must ensure all safety recommendations given in this manual, as well as any issued through government legislation, are carefully followed.

Our recommendations and safety instructions should not be considered as the only ones to follow.

## Safety decals on the fertiliser spreader ZSA

- o The safety decals give important advice for all persons working with this machine.
- o Point out to all persons working with this machine to read and understand the safety decals.
- o Replace all damaged safety decals. You can order them from your dealer.
- o Always clean the decals, if they become unreadable.

1

### CAUTION! THINK SAFETY!

- Read and understand operators manual before operating the machine. Follow all service and operating safety instructions.
- Learn to operate this machine safely. Machine can be hazardous in hands of an untrained or complacent operator.
- The operator must make absolutely sure that no person or animal is in the projection zone of the machine before starting it and during its operation.
- Each time before using the machine, verify that all fixing devices (nuts, bolts etc.) are sufficiently tightened.
- Before carrying out adjustments, greasing or declogging the machine, turn off the tractor and disconnect P.T.O.-shaft.
- Wait for all moving parts to completely stop before approaching the machine.
- Always keep hands, feet and clothing away from moving parts.
- Do not permit anyone to ride on the machine.
- Take care the P.T.O. is kept protected and fix the protection tube chain to a secure point.
- Always stop engine before leaving operators position, never allow the machine to run unattended. In any case make sure precautions are taken.
- Never stand between tractor and implement while engine is running.
- Make certain everyone is clear of machine before starting engine or operation.
- Never work on top or inside the hopper unless tractor engine is shut off.
- Before driving in a public area, the driver must ensure that the machine is equipped with guards and safety indicators conforming to the highway code. Use a flashing warning light, when transporting on highway except where prohibited by law.
- Attention - Safety! Match tractor ballast to combine spreader and fertilizer weight.
- If you do not have a operators manual, please order one immediately from your dealer.

WS E 01367

2  
**ZSA 600/800**

Max. Nutzlast:  
Chargo utile max.:  
Max. payload:  
Max. inhoud:  
Max. nyttelast:

## 1200 kg

2  
**ZSA 450**

Max. Nutzlast:  
Chargo utile max.:  
Max. payload:  
Max. inhoud:  
Max. nyttelast:

## 600 kg

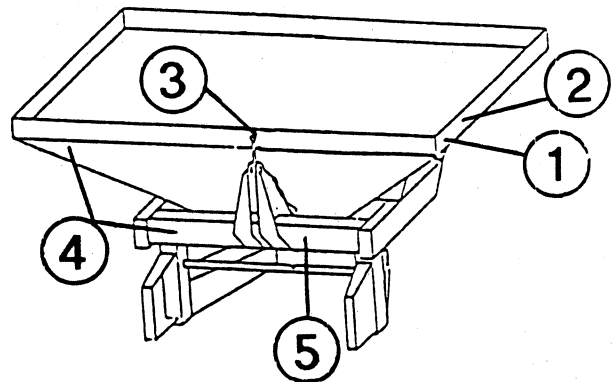
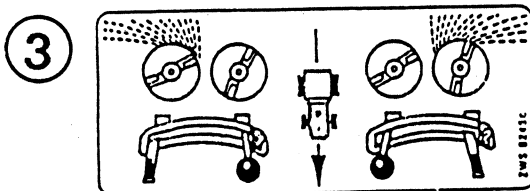

4

**← ACHTUNG! IMPORTANT! LET OP!**

Die Seriennummern des Rahmens und des Behälters müssen identisch sein!  
Chassis must only be fitted with hopper having corresponding serial number!  
Les numéros de chassis et de trémie doivent être identiques!  
Het serienummer op het frame en op de trechter moeten beslist gelijk zijn!

WS 0489

5

max.  
**600 min<sup>-1</sup>**

## 1. TECHNICAL DATA

### 1.1 TECHNICAL DETAILS OF THE ZSA-range

	Hopper size cm	Filling height cm	Filling width cm	Capacity		Working widths m	Power requirement kW	Weight kg
				appr. ltr.	max. payload appr. kg			
ZSA 450	125 x 125	88	118	450	600	10/12 m depending on fertiliser	25	133
ZSA 580	125 x 125	94	118	580	800		30	153
ZSA 600	160 x 120	90	153	600	1200 (Cat. II)		30	175
ZSA 800	160 x 120	100	153	800	1200 (Cat. II)		35	185
Extension for ZSA 600/800 capacity: 250 ltrs.	160 x 120	+14	153					27

### 1.2 SCOPE OF FERTILISERS

The twin-disc fertiliser spreaders ZSA are suitable for spreading all granulated and prilled fertilisers. With the agitator for powdered fertiliser spreading dry and powdered fertilisers is possible.

## 2. RECOMMENDATIONS REGARDING NEW MACHINES

### 2.1 INSPECTION

Make sure serial number on frame (positioned on front r.h. face) and hopper (positioned on top r.h. corner of front face) are identical.

Further check correct assembly of discs: left (L) disc and right (R) disc. Identification letters "L" or "R" are stamped in the centre of discs.

Before use check tightness of nuts and bolts.

Damaged or missing parts have to be certified immediately by the carrier. In case of doubt get in contact with the representative manufacturer.

### 2.2 STANDARD EQUIPMENT

1 Stirrer head (with 2 fingers), 2 lower link pins, 1 upper link pin, 1 P.T.O.-shaft and 1 set of discs.

## 2.3 OPTIONAL EQUIPMENT

- o Late top dressing discs
- o Extension for ZSA 600 to 800 ltrs.  
Extension for ZSA 800 to 1000 ltrs.
- o Calibration kit
- o Boundary spread limiter GHN
- o Hopper screen for ZSA 600 + 800
- o Hopper cover for ZSA 600 + 800
- o Row equipment RFZ for 4 or 6 rows
- o Row equipment RV 2 E, working width 2-4 m (distance of rows 6.5' to 13').
- o Agitator for powdered fertiliser
- o Light supports for ZSA 600 + 800
- o Lights with brackets
- o Hydraulic remote controls

With the hydraulic remote controls it is possible, while spreading, to close or open the outlet shutters or to spread only to the left side.

With a single acting control valve we recommend remote control FH 1 K with ball type valve.

With a double acting control FHD 2 is necessary.

- o Electronic metering control
- o Friction clutch

## 3. OPERATING INSTRUCTIONS

### 3.1 P.T.O.-SHAFT



Before attaching the P.T.O.-shaft shut-off engine and P.T.O. and pull out ignition key.

Check length of P.T.O.-shaft. Incorrect P.T.O.-shaft lengths will result in premature failure.

#### 1. In its longest position:

An overlap of at least 100 mm (4") must be maintained.

#### 2. Maximum overlap (P.T.O.-tubes) retracted:

Tubes should not butt against their cross journals. A safety margin (a) of at least 1 cm (3/8") must be maintained (Fig. 1).

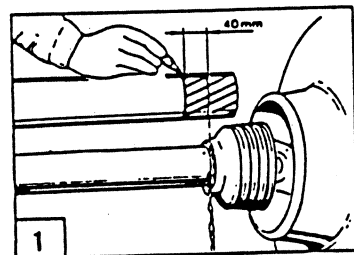



3. If this is not the case, shorten tubes and guards by an equal amount (Fig. 2 and 3).

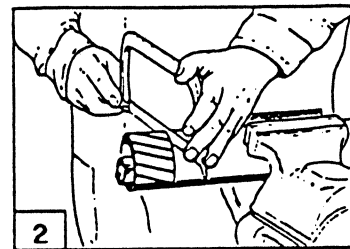

4. File and clean transmission tube (Fig. 4).

5. Apply grease to the inside of the outer transmission tubes (Fig. 5)

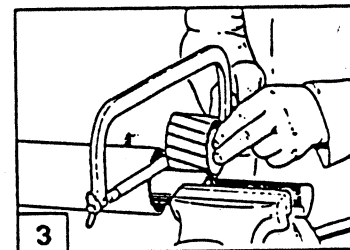

6. Reassemble the two P.T.O. half shafts and connect the complete assembly to the tractor's P.T.O. and spreader input shaft. Attach the free end of the safety chains to a fixed point on the tractor and spreader (Fig. 6).

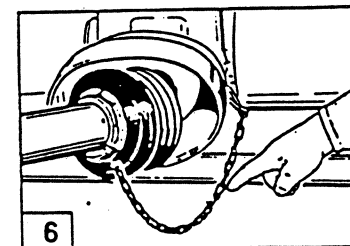
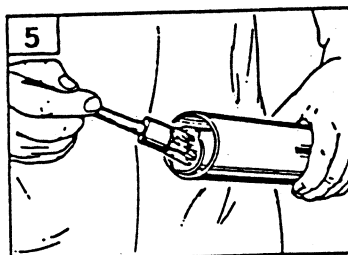
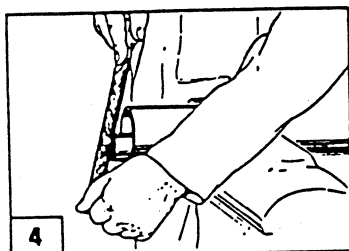

**ATTENTION:**

While spreading, the angle of the P.T.O.-shaft should not be more than 25°, otherwise a wide-angle drive-shaft is recommended.

7. Engage the clutch only with low P.T.O. rev's.



**ATTENTION:**

We strongly recommend that all these recommendations and basic adjustments be respected to avoid premature deterioration of the P.T.O.-shaft.

**WARNING:**



Make sure that the P.T.O.-guards are always properly in place.

To avoid accidents which could be serious, always check that the safety guards are firmly in place and to prevent their rotation, attach the free end of the safety chain to a fixed point on the tractor or spreader. Replace immediately worn or damaged guards, using original parts.

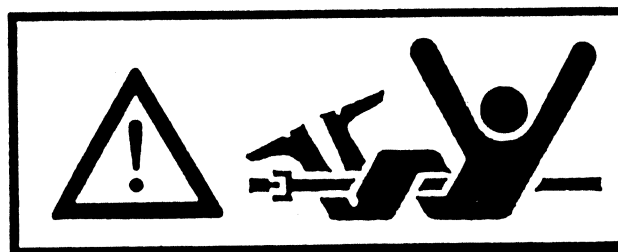

## ADDITIONAL ADVICES FOR ATTACHMENT OF A FRICTION CLUTCH (OPTIONAL EQUIPMENT)

 The friction clutch has only to be attached to the spreader. It is most important to have the friction clutch checked after each season.

- o Attach P.T.o. shaft on spreader until the screw is exactly over the packing ring.
- o Tighten screw and secure with conter nut.

 **IMPORTANT!** Check tightness of screw regularly.

### 3.2 ATTACHMENT TO THE 3-POINT-LINKAGE

- o Attach machine according to instructions.
- o Before attaching/detaching the machine to the 3-point-linkage take care that the operation levers are in the right position to avoid unaccidental lifting and lowering.
- o When attaching the machine to the 3-point-linkage take care that the machine is conform to the necessary category.
- o There is dange of injury in the area of the three point linkage by its squeezing and shearing places.
- o When operating the 3-point-linkage do not stand between tractor and spreader.
- o On transport take care that the 3-point-linkage is well secured.
- o On transport on roads, the operation lever has to be secured against lowering.

Attach spreader to the 3-point-linkage (Cat. I or II). Spreader should be mounted so that frame and hopper are horizontal from side to side when on level ground. The lower link arms should be adjusted to prevent sideways movement.

Refer to calibration chart for setting height of spreader from back to the front.

**Note:** With the standard lower linkage it is possible to mount spreader 140 mm (5.5") higher (e.g. for late top dressing).

The working width depends on the height of the discs. The values given are the effective spreading width or overlapped spreading.

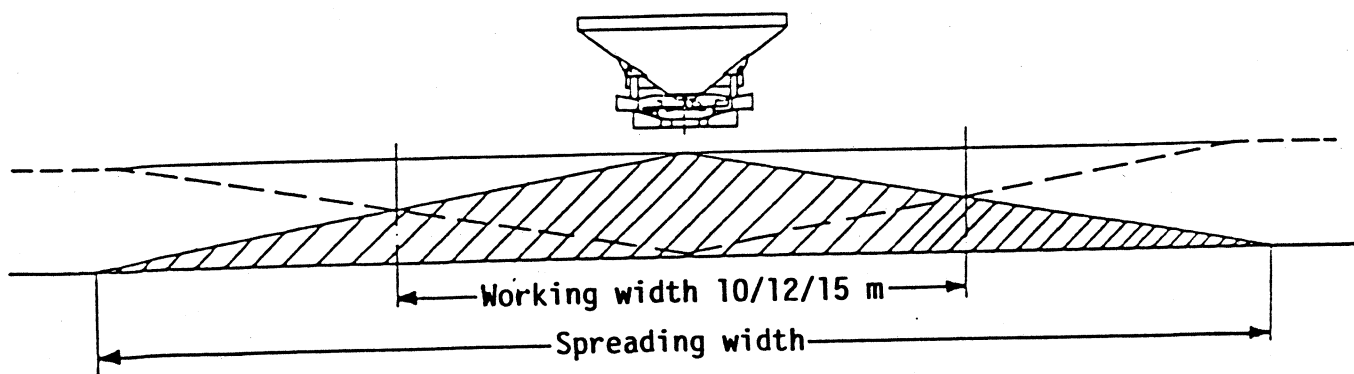

**ATTENTION!**

**ROTATING ELEMENTS!**

**DANGER DUE TO PROJECTION OF FERTILISER PARTICLES!  
KEEP ALL PERSONS AWAY FROM THE DANGER AREA!**

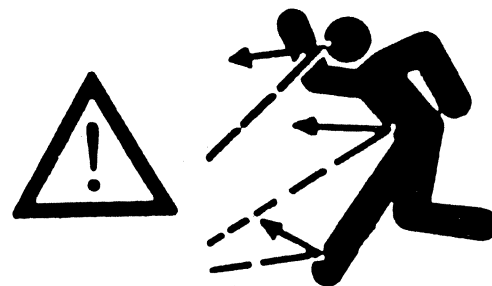

### 3.3 HYDRAULIC REMOTE CONTROLS FH 1 K, FHD 1 (OPTIONAL EQUIPMENT)

(fitting instructions: see separate operators manual).

#### FH 1 K

For operation of these hydraulic remote controls a single acting valve is necessary. Pressure from the tractor closes the outlet shutters and a spring inside the cylinder opens them.

For spreading to one side only, disconnect the application rate adjustment levers. This allows operation of the left hand side outlet shutter with the hydraulic cylinder.

To ensure that the outlet shutters do not open during filling or when the machine is being transported for any long distance it is recommended that the tap in the hydraulic hose is closed.

When the spreader is being stored for a long period, it is recommended that the outlets are left open to reduce tension on the cylinder spring.

#### FHD 1

For operation of these hydraulic remote controls a double acting valve is necessary.

For spreading to one side only, disconnect the application rate adjustment levers. This allows operation of the left hand side outlet shutter with the hydraulic cylinder.

#### IMPORTANT:

Remote control with one cylinder:



When using the hydraulic remote control, set the application rate adjustment stop in one position lower than indicated in the calibration chart. Example: The calibration chart indicates 16: set 1 position lower = 15.

To ensure correct operation, grease regularly the shut-off slides and pivot joints. In special cases it would be recommended to detach the leaf springs from the application rate adjustment levers which run across the graduated scale by drilling out the rivets.

### 3.4 ADJUSTMENT OF QUANTITY APPLICATION

#### ATTENTION:



Fertiliser density varies with type and even different batches of the same material. It is therefore absolutely essential that the machine to spread the fertiliser is checked, to ensure that the correct setting is chosen to deliver the precise weight of fertiliser in a given time.

The calibration charts are only intended to provide a guide to the setting required. The figures were calculated by testing a machine with the aid of a computer using representative samples of fertilisers etc. This is no guarantee that your material is of the same type or density or has the same handling characteristics.

#### Spreading of urea



The highly concentrated nitrogenous fertilisers urea vary considerably in their qualities and grain sizes. Therefore another spreader adjustment can become necessary. Also mind the fertiliser's high wind sensitivity.



Before carrying out adjustments, greasing, cleaning or declogging the machine, turn-off the tractor and disconnect the P.T.O.-shaft.

Wait for all moving parts to completely stop before approaching the machine.

Read on the calibration chart the adjustment and scale to be set according to the chosen speed and wanted quantity and adjust it on the shut-off-lever (grey edge on one of the 39 control positions).

When adjusting the scale, the stop may be set in either of two positions. If you want only to adjust one position, turn the lever on the scale stop and engage it into the opposite holes (see fig.) and move one position.

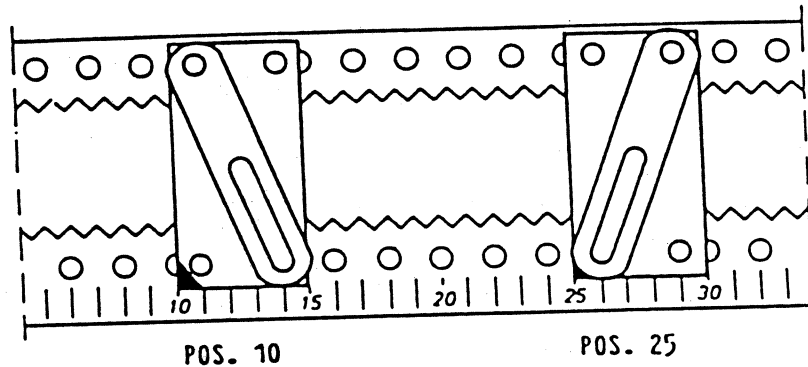

**IMPORTANT:**

**Adjustment of quantity with hydraulic remote control: Set the stop in 1 position lower.**

To begin spreading both control levers have to be pushed against the scale stop. When spreading on one side only, use the corresponding lever (see indication on hopper).

For single lever operation: uncouple by lifting connecting lever.

For best results it is essential to calibrate the spreader output and adjust accordingly.

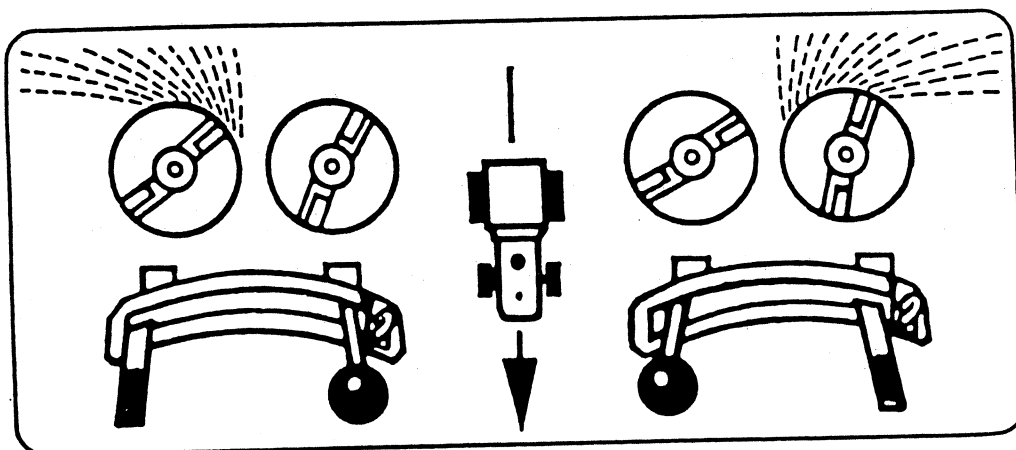

### 3.5 CONTROL OF SPREADING QUANTITY WITH CALIBRATION KIT (OPTIONAL EQUIPMENT)

To check the spreading quantity easily, we offer a calibration kit as our optional equipment. The test is carried out with the spreader mounted behind a parked tractor and the quantity of fertiliser collected in the time indicated below is measured.

To get the best possible results it is advisable to make this test with tractor moving a distance of 100 m and timing exactly.

Fix the driving speed using the following formula or the scale:

$$\text{Driving speed (m.p.h.)} = \frac{\text{Driving speed}}{\text{time sec./100 m}}$$

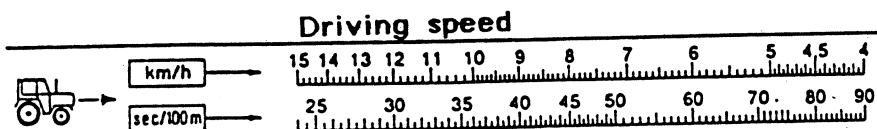

The test is made on the left outlet. However, the calculation is made for 2 outlets i.e. divide the quantity by 2.

Then use the following formula to get the testing quantity kg/min (lbs/min).

Calculation in metric:

$$\frac{\text{application rate (kg/ha)} \times \text{spreading width (m)} \times \text{forward speed (km/h)}}{600 \text{ (constant)}}$$

Example: Application rate: 125 kg/ha  
 Spreading width: 12 m  
 Forward speed: 8 km/h

$$\frac{125 \times 12 \times 8}{600} = 20 \text{ kg/min}$$

This quantity then has to be divided by 2 to give the quantity collected from one outlet. E.g.  $\frac{20}{2}$  kg/min = 10 kg/min must be collected from one outlet in one minute.

Calculation in imperial:

$$\frac{\text{application rate (lbs/acre)} \times \text{spreading width (ft)} \times \text{forward speed (m.p.h.)}}{495 \text{ (constant)}}$$

Example: Application rate: 112 lbs/acre  
 Spreading width: 40 ft  
 Forward speed: 5 m.p.h.

$$\frac{112 \times 40 \times 5}{495} = 45 \text{ lbs/min}$$

This quantity then has to be divided by 2 to give the quantity collected from one outlet. E.g.  $\frac{45,25}{2}$  lbs/min = 22 1/2 lbs/min.

With the calculator this calculation can be made easily:

Slide the wanted spreading quantity 400 lbs/min under the planned spreading width 40 ft and read off at the set driving speed 4 m.p.h. the fertiliser quantity 130 lbs/acre.

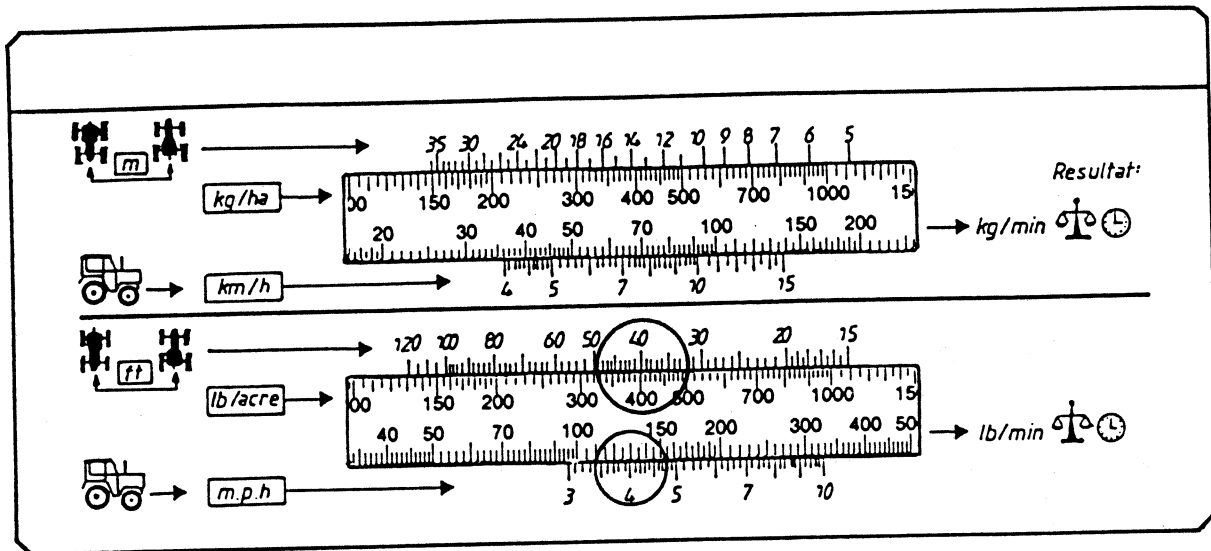

#### Use of calibration kit (optional equipment)

- Remove the left hand side disc (seen in driving direction).
- Hang in the chute and put the bucket onto the bottom.
- When using the kit for the very first time, stick the PVC-part  to the left side of the hitch (on side of gearbox).
- Read on the calibration chart the adjustment and scale to be set according to the chosen speed and wanted quantity and adjust it on the shut-off lever.
- Turn on P.T.O. to 540 r.p.m. Open now completely the left shut-off slide.

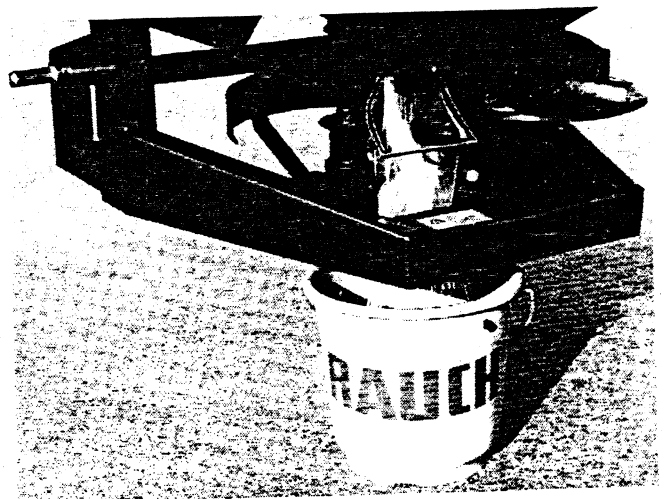

### 3.6 LATE TOP DRESSING

For late top dressing we offer special discs (optional equipment) especially designed for this kind of work.



Make sure not to mix up the left and right disc.

The identification letters "R" (right) and "L" (left) are stamped in the middle of the disc (see also decal).

#### Changing of discs:

Loosen stainless steel nuts, take off discs.

Note: To ensure correct fitting discs can only be fitted in one position.



Make sure that the steel nuts are sufficiently tightened.

After the first working hour check tightness of nuts and bolts.

The discs must be adjusted in horizontal position (same height as crop)  
- see calibration chart.

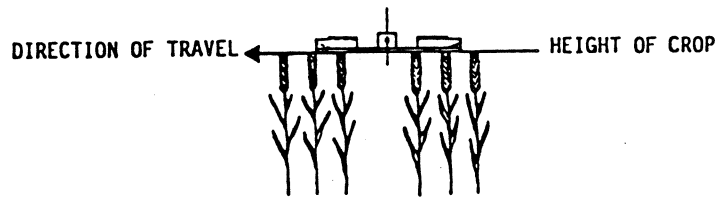

If the spreader cannot be adjusted in this height, it is possible to mount the spreader 140 mm (5.5") higher.

Spreading quantities: See normal calibration chart!



#### IMPORTANT:

If the angle of the P.T.O.-shaft is more than 25°, please use a wide-angle drive shaft.

### 3.7 ONE SIDE SPREADING, HEADLAND SPREADING

For spreading to one side only (left or right) the shut-off levers have to be disconnected and positioned accordingly.

With the optional equipment "boundary spread limiter" it is possible to spread along the edge of the field without spreading fertiliser into the hedge.

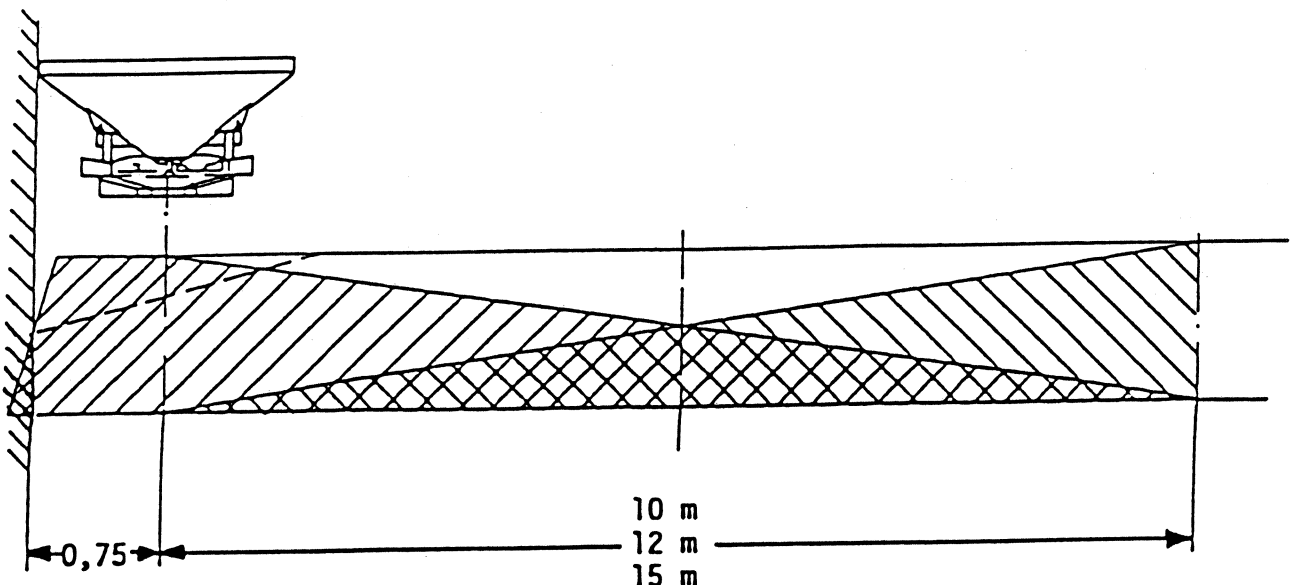

#### 4. MAINTENANCE

- o Before carrying out adjustments and maintenance shut-off engine and pull out the ignition key. Wait for all moving parts to completely stop before approaching the machine.
- o When carrying out maintenance with machine lifted up, secure machine by adequate support devices.
- o For your safety and get the best from your machine, use only genuine parts from the manufacturer.
- o Check nuts and screws to be correctly tightened.
- o After adjusting, maintaining and cleaning the machine attach again all safety guards correctly.

Thorough cleaning or washing after every use guarantees a long spreader life.

For cleaning the hopper can be taken off after having removed the retaining nuts and the stirrer head.

After cleaning it is advisable to spray the machine with a film of oil.



After every use the stirrer-head should be taken out and the hole of stirrer-head and stirrer-head drive shaft should be slightly greased.

The gearbox is permanently lubricated and is therefore maintenance-free. The oil drain plug is also a filler plug. It is recommended to change the oil every 2-3 years, especially when cleaning the gearbox regularly with a high pressure steam cleaner (filling capacity: 1 l gear oil HD 140). It is not necessary to top up the gearbox with oil between the oil change intervals or at pre-delivery inspection.



Note: The oil drain/filler plug must not be used as a oil level plug.

To maintain an even spreading pattern, it is necessary that the discs are always cleaned and changed when damaged.

In the factory the shut-off slides are adjusted at position 2 to open 1 mm. In case of irregularity the angled adjusting joints should be re-set.



After each cleaning this greasing nipple must be lubricated.



## 5. ADDITIONAL ADVICES

5.1 Check the tightness of all nuts and bolts after 20 working hours.

### 5.2 Payload

The max. payload of the ZSA 450 is 600 kgs and of the ZSA 600 + 800 1200 kgs. Do not load the machine beyond the capacity as we cannot accept any claims due to overloading.

When using bulk fertiliser the load can be calculated by the density of fertiliser.

Weigh exactly one liter to find the density in kg/l.



**Check the density before filling hopper.**

As approximate values the following densities are valid:

appr. 0,8 kg/l	Urea
appr. 1,0 kg/l	Prilled Nitrates
appr. 1,2 kg/l	NPK, Potash
appr. 1,4 kg/l	Phosphate, Kieserit

In the calibration chart the densities are indicated for each fertiliser.

Keep the following loads for ZSB-models:

ZSA 450: 450 ltr. - 600 kg

0,8 kg/l - 1,3 l

1,6 kg/l

Hopper can be filled normally.

Fill hopper until 5 cm below the hopper's top.

ZSA 600: 600 l - 1200 kg

Hopper can be filled normally with all fertilisers.

ZSA 800: 800 l - 1200 kg

0,8 kg/l - 1,5 kg/l

1,6 kg/l

Hopper can be filled normally.

Fill hopper until 5 cm below the hopper's top.

ZSA 800 with  
extension 1000:

1000 l - 1200 kg

0,8 kg/l - 1,2 kg/l

1,6 kg/l

Hopper can be filled normally.

Fill hopper until 12 cm below the hopper's top.

5.3 Engage the clutch only at low P.T.O. speed.

5.4 **WARNING:** Make sure everyone is standing clear of rotating discs, away from danger of injury!

### 5.5 Changing of discs:

Loosen stainless steel nuts, take off discs.

**Note:** To ensure correct fitting discs can only be fitted in one position.

**Make sure not to mix up the left and right discs.** L or R is marked down behind a disc fin (also stickers on each blade).

5.6 Before driving in a public area, the driver must ensure that the machine is equipped with guards and safety indicators conforming to the highway code.

## 6. IMPORTANT RECOMMENDATIONS FOR ACCURATE SPREADING

Through modern design techniques, care to detail at all stages of manufacture and constant testing in our testing hall, we have produced a machine that will give an accurate and uniform spread pattern providing the following recommendations are followed:

1. Use of the same type of fertiliser as indicated in our calibration charts.
2. Spread when wind is at a minimum (preferably when still).
3. Spreader should be horizontal from side to side when on level ground and lower link arms adjusted to prevent sideway movement.
4. Inclination of spreader from back to front has to be set according to calibration chart, measured from the ground or the top of the crop.
5. Check the application rate by using calibration kit.
6. With the outlet shutter closed there should be no loss of fertiliser.
7. Open or shut outlet shutters with P.T.O. operating at 540 r.p.m.
8. Maintain constant tractor forward speed when spreading.
9. Maintain constant P.T.O. speed when spreading.
10. Wash spreader down at the end of each days use (agitator and hopper can be detached).
11. Keep outlet openings always clean.
12. Change discs, blades and stirrer-head when worn or damaged.
13. Discs should be replaced if they become bent.